

Altivar 32

Variable speed drives
for synchronous and asynchronous motors

Programming Manual

03/2010



The information provided in this documentation contains general descriptions and/or technical characteristics of the performance of the products contained herein. This documentation is not intended as a substitute for and is not to be used for determining suitability or reliability of these products for specific user applications. It is the duty of any such user or integrator to perform the appropriate and complete risk analysis, evaluation and testing of the products with respect to the relevant specific application or use thereof. Neither Schneider Electric nor any of its affiliates or subsidiaries shall be responsible or liable for misuse of the information contained herein. If you have any suggestions for improvements or amendments or have found errors in this publication, please notify us.

No part of this document may be reproduced in any form or by any means, electronic or mechanical, including photocopying, without express written permission of Schneider Electric.

All pertinent state, regional, and local safety regulations must be observed when installing and using this product. For reasons of safety and to help ensure compliance with documented system data, only the manufacturer should perform repairs to components.

When devices are used for applications with technical safety requirements, the relevant instructions must be followed.

Failure to use Schneider Electric software or approved software with our hardware products may result in injury, harm, or improper operating results.

Failure to observe this information can result in injury or equipment damage.

© 2010 Schneider Electric. All rights reserved.

Table of Contents

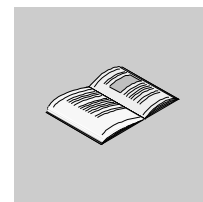

| | | |
|------------------|--|-----------|
| | Safety Information | 7 |
| | About the Book | 8 |
| | General Overview | 11 |
| Chapter 1 | Setup | 13 |
| | Steps for setting-up the drive | 14 |
| | Preliminary recommendations | 15 |
| Chapter 2 | Overview | 17 |
| | Factory configuration | 18 |
| | Application functions | 19 |
| | Basic functions | 23 |
| | Graphic display terminal option | 24 |
| | Powering up the drive for the first time | 27 |
| | Remote display terminal option | 30 |
| | Structure of the parameter tables | 31 |
| | Finding a parameter in this document | 32 |
| | Description of the HMI | 33 |
| | Structure of the menus | 34 |
| | Programming | 35 |
| Chapter 3 | Reference Mode (rEF) | 37 |
| | Introduction | 38 |
| | Organization tree | 39 |
| | Menu | 40 |
| Chapter 4 | Monitoring Mode (MOn) | 41 |
| | Introduction | 42 |
| | Organization tree | 43 |
| | Menu | 44 |
| | [MONIT. MOTOR] | 44 |
| | [I/O MAP] | 45 |
| | [MONIT. SAFETY] | 48 |
| | [MONIT. FUN. BLOCKS] | 49 |
| | [COMMUNICATION MAP] | 50 |
| | [MONIT. PI] | 56 |
| | [MONIT. POWER TIME] | 56 |
| | [ALARMS] | 57 |
| | [OTHER STATE] | 58 |
| | [DIAGNOSTICS] | 58 |
| | [PASSWORD] | 63 |
| Chapter 5 | Configuration Mode (ConF) | 65 |
| | Introduction | 66 |
| | Organization tree | 67 |
| | My Menu | 68 |

| | |
|---|------------|
| Factory Settings | 69 |
| Macro Configuration | 70 |
| Full | 73 |
| [SIMPLY START] | 73 |
| [SETTINGS] | 77 |
| [MOTOR CONTROL] | 92 |
| [INPUTS / OUTPUTS CFG] | 112 |
| [COMMAND] | 139 |
| [FUNCTION BLOCKS] | 143 |
| [APPLICATION FUNCT.] (FU _n -) | 147 |
| REFERENCE SWITCHING | 152 |
| REFERENCE OPERATIONS | 153 |
| RAMP | 155 |
| STOP CONFIGURATION | 158 |
| AUTO DC INJECTION | 161 |
| JOG | 163 |
| PRESET SPEEDS | 165 |
| +/- SPEED | 169 |
| +/- SPEED AROUND A REFERENCE | 171 |
| REFERENCE MEMORIZING | 173 |
| FLUXING BY LOGIC INPUT | 174 |
| BRAKE LOGIC CONTROL | 176 |
| EXTERNAL WEIGHT MEASUREMENT | 184 |
| HIGH SPEED HOISTING | 186 |
| PID REGULATOR | 192 |
| PID PRESET REFERENCES | 200 |
| TORQUE LIMITATION | 201 |
| 2ND CURRENT LIMITATION | 204 |
| LINE CONTACTOR COMMAND | 205 |
| OUTPUT CONTACTOR COMMAND | 207 |
| POSITIONING BY SENSORS | 209 |
| PARAMETER SET SWITCHING | 214 |
| MULTIMOTORS / MULTICONFIGURATIONS | 217 |
| AUTO TUNING BY LOGIC INPUT | 221 |
| TRAVERSE CONTROL | 222 |
| [COMMUNICATION] | 256 |
| Access Level | 260 |
| Chapter 6 | |
| Interface (ItF) | 261 |
| Access Level (LAC) | 262 |
| Language (LnG) | 264 |
| Monitoring Configuration (MCF) | 265 |
| Display configuration (dCF) | 269 |
| Chapter 7 | |
| Open / Save as (trA) | 277 |
| Chapter 8 | |
| Password (COd) | 281 |
| Chapter 9 | |
| Multipoint Screen | 283 |
| Maintenance and Diagnostics | 285 |
| Chapter 10 | |
| Maintenance | 287 |
| Chapter 11 | |
| Diagnostics and Troubleshooting | 289 |
| Error code | 290 |
| Clearing the detected fault | 290 |
| Fault detection codes which require a power reset after the detected fault is cleared | 291 |
| Fault detection codes that can be cleared with the automatic restart function after the cause has disappeared | 293 |
| Fault detection codes that are cleared as soon as their cause disappears | 295 |

| | | |
|-------------------|--|------------|
| | Option card changed or removed | 295 |
| | Control block changed | 295 |
| | Fault detection codes displayed on the remote display terminal | 296 |
| | Annex | 297 |
| Chapter 12 | Index of Functions | 299 |
| Chapter 13 | Index of Parameter Codes | 301 |

Safety Information

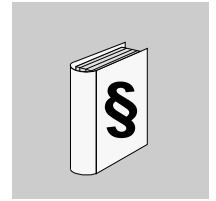

Important Information

NOTICE

Read these instructions carefully, and look at the equipment to become familiar with the device before trying to install, operate, or maintain it. The following special messages may appear throughout this documentation or on the equipment to warn of potential hazards or to call attention to information that clarifies or simplifies a procedure.



The addition of this symbol to a Danger or Warning safety label indicates that an electrical hazard exists, which will result in personal injury if the instructions are not followed.



This is the safety alert symbol. It is used to alert you to potential personal injury hazards. Obey all safety messages that follow this symbol to avoid possible injury or death.

DANGER

DANGER indicates an imminently hazardous situation, which, if not avoided, **will result** in death or serious injury.

WARNING

WARNING indicates a potentially hazardous situation, which, if not avoided, **can result** in death, serious injury, or equipment damage.

CAUTION

CAUTION indicates a potentially hazardous situation, which, if not avoided, **can result** in injury or equipment damage.

CAUTION

CAUTION, used without the safety alert symbol, indicates a potentially hazardous situation which, if not avoided, **can result** in equipment damage.

PLEASE NOTE

The word "drive" as used in this manual refers to the controller portion of the adjustable speed drive as defined by NEC.

Electrical equipment should be installed, operated, serviced, and maintained only by qualified personnel. No responsibility is assumed by Schneider Electric for any consequences arising out of the use of this product.

© 2010 Schneider Electric. All Rights Reserved.

About the Book

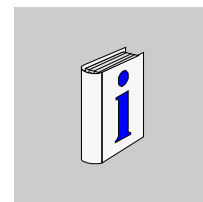

At a Glance

Document scope

The purpose of this document is to:

- help you to set-up the drive,
- show you how to program the drive,
- show you the different menus, modes and parameters,
- help you in maintenance and diagnostics.

Validity note

This documentation is valid for the Altivar 32 drive.

Related documents

| Title of Documentation | Reference Number |
|--|------------------|
| ATV32 Quick Start | S1A41715 |
| ATV32 Installation manual | S1A28686 |
| ATV32 Modbus manual | S1A28698 |
| ATV32 CANopen manual | S1A28699 |
| ATV32 Communication Parameters | S1A44568 |
| ATV32 Atex manual | S1A45605 |
| ATV32 Safety manual | S1A45606 |
| ATV32 other option manuals: see www.schneider-electric.com | |

You can download the latest versions of these technical publications and other technical information from our website at www.schneider-electric.com.

Product related information

⚠ ⚠ DANGER

HAZARD OF ELECTRIC SHOCK, EXPLOSION OR ARC FLASH

- Read and understand this manual before installing or operating the Altivar 32 drive. Installation, adjustment, repair, and maintenance must be performed by qualified personnel.
- The user is responsible for compliance with all international and national electrical code requirements with respect to grounding of all equipment.
- Many parts of this drive, including the printed circuit boards, operate at the line voltage. **DO NOT TOUCH.** Use only electrically insulated tools.
- **DO NOT** touch unshielded components or terminal strip screw connections with voltage present.
- **DO NOT** short across terminals PA/+ and PC/- or across the DC bus capacitors.
- Before servicing the drive:
 - Disconnect all power, including external control power that may be present.
 - Place a "DO NOT TURN ON" label on all power disconnects.
 - Lock all power disconnects in the open position.
 - **WAIT 15 MINUTES** to allow the DC bus capacitors to discharge.
 - Measure the voltage of the DC bus between the PA/+ and PC/- terminals to ensure that the voltage is less than 42 Vdc.
 - If the DC bus capacitors do not discharge completely, contact your local Schneider Electric representative. Do not repair or operate the drive.
- Install and close all covers before applying power or starting and stopping the drive.

Failure to follow these instructions will result in death or serious injury.

⚠ DANGER

UNINTENDED EQUIPMENT OPERATION

- Read and understand this manual before installing or operating the Altivar 32 drive.
- Any changes made to the parameter settings must be performed by qualified personnel.

Failure to follow these instructions will result in death or serious injury.

⚠ WARNING

DAMAGE DRIVE EQUIPMENT

Do not operate or install any drive or drive accessory that appears damaged.

Failure to follow these instructions can result in death, serious injury, or equipment damage.

⚠ WARNING

LOSS OF CONTROL

- The designer of any control scheme must
 - consider the potential failure modes of control paths and, for certain critical control functions,
 - provide a means to achieve a safe state during and after a path failure.Examples of critical control functions are emergency stop and overtravel stop.
- Separate or redundant control paths must be provided for critical control functions.
- System control paths may include communication links. Consideration must be given to the implications of unanticipated transmission delays or failures of the link.⁽¹⁾

Failure to follow these instructions can result in death, serious injury, or equipment damage.

(1) For additional information, refer to NEMA ICS 1.1 (latest edition), "Safety Guidelines for the Application, Installation, and Maintenance of Solid State Control" and to NEMA ICS 7.1 (latest edition), "Safety Standards for Construction and Guide for Selection, Installation and Operation of Adjustable-Speed Drive Systems."

⚠ CAUTION**INCOMPATIBLE LINE VOLTAGE**

Before turning on and configuring the drive, ensure that the line voltage is compatible with the supply voltage range shown on the drive nameplate. The drive may be damaged if the line voltage is not compatible.

Failure to follow these instructions can result in injury or equipment damage.

CAUTION**RISK OF DERATED PERFORMANCE DUE TO CAPACITOR AGING**

The product capacitor performances after a long time storage above 2 years can be degraded. In that case, before using the product, apply the following procedure:

- Use a variable AC supply connected between L1 and L2 (even for ATV32●●●N4 references).
- Increase AC supply voltage to have:
 - 25% of rated voltage during 30 min
 - 50% of rated voltage during 30 min
 - 75% of rated voltage during 30 min
 - 100% of rated voltage during 30 min

Failure to follow these instructions can result in equipment damage.

User comments

The word "drive" as used in this manual refers to the controller portion of the adjustable speed drive as defined by NEC.

General Overview

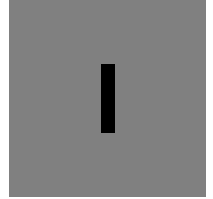

What's in this Part?

This part contains the following chapters:

| Chapter | Chapter Name | Page |
|---------|--------------|--------------------|
| 1 | Setup | 13 |
| 2 | Overview | 17 |

Setup



1

What's in this Chapter?

This chapter contains the following topics:

| Topic | Page |
|--------------------------------|--------------------|
| Steps for setting-up the drive | 14 |
| Preliminary recommendations | 15 |

Steps for setting-up the drive

INSTALLATION

1. Please refer to the installation manual.



Tips:

- Before beginning programming, complete the customer setting tables, page [301](#).
- Use the **[Restore config.]** (*F C 5*) parameter, page [69](#), to return to the factory settings at any time.
- To locate the description of a function quickly, use the index of functions page [299](#).
- Before configuring a function, read carefully the "Function compatibility" section page [150](#).

Note: The following operations must be performed for optimum drive performance in terms of accuracy and response time:

- Enter the values indicated on the motor rating plate in the **[MOTOR CONTROL]** (*d r C -*) menu, page [92](#).
- Perform auto-tuning with the motor cold and connected using the **[Auto-tuning]** (*t U n*) parameter, page [75](#).

PROGRAMMING

2. Apply input power to the drive, but do not give a run command.

3. Configure:

- The nominal frequency of the motor **[Standard mot. freq]** (*b F r*) page [74](#) if this is not 50 Hz.
- The motor parameters in the **[MOTOR CONTROL]** (*d r C -*) menu, page [92](#), only if the factory configuration of the drive is not suitable.
- The application functions in the **[INPUTS / OUTPUTS CFG]** (*I _ O -*) menu, page [112](#), the **[COMMAND]** (*C E L -*) menu, page [139](#), and the **[APPLICATION FUNCT.]** (*F U n -*) menu, page [152](#), only if the factory configuration of the drive is not suitable.

4. In the **[SETTINGS]** (*S E t -*) menu, adjust the following parameters:

- **[Acceleration]** (*A C C*), page [75](#) and **[Deceleration]** (*d E C*), page [75](#).
- **[Low speed]** (*L S P*), page [75](#) and **[High speed]** (*H S P*), page [77](#).
- **[Mot. therm. current]** (*I t H*), page [75](#).

5. Start the drive.

Preliminary recommendations

Before powering up the drive

DANGER

UNINTENDED EQUIPMENT OPERATION

Read and understand this manual before installing or operating the ATV32 drive.
Any changes made to the parameter settings must be performed by qualified personnel.
Check that all logic inputs are inactive to avoid any unintended operation.

Failure to follow these instructions will result in death or serious injury.

Start-up

Note: When factory settings apply and during power-up/manual reset or after a stop command, the motor can only be powered once the "forward", "reverse" and "DC injection stop" commands have been reset. If they have not been reset, the drive will display **[Freewheel stop] (n 5 t)** but will not start. If the automatic restart function has been configured (**[Automatic restart] (R t r)** parameter in the **[FAULT MANAGEMENT] (F L t -)** menu, page 232), these commands are taken into account without a reset (to zero) being necessary.

Line contactor

CAUTION

RISK OF DAMAGE TO DRIVE

Frequent use of the contactor will cause premature aging to the charge circuit of the filter capacitors.
Do not power-up the drive less than every 60 seconds.

Failure to follow these instructions can result in equipment damage.

Using a motor with a lower rating or dispensing with a motor altogether

With the factory settings, motor output phase loss detection is active (**[Output Phase Loss] (O P L) = [Yes] (y e s)**, page 238). To avoid having to use a motor with the same rating as the drive when testing the drive or during a maintenance phase, deactivate the motor output phase loss detection (**[Output Phase Loss] (O P L) = [No] (n o)**). This can prove particularly useful if very large drives are being tested with a small motor.

Set **[Motor control type] (C t t)**, page 92, to **[Standard] (S t d)** in **[Motor control menu] (d r c -)**.

CAUTION

RISK OF DAMAGE TO THE MOTOR

Motor thermal protection will not be provided by the drive if the motor 's nominal current is 20% lower than that of the drive.

In this case, find an alternative source of thermal protection.

Failure to follow these instructions can result in equipment damage.

DANGER

HAZARD OF ELECTRIC SHOCK, EXPLOSION OR ARC FLASH

If **[Output Phase Loss] (O P L)** is set to **[No] (n o)**, Loss of cable is not detected.
Check that this action will not endanger personnel or equipment in any way.

Failure to follow these instructions will result in death or serious injury.

Overview

2

What's in this Chapter?

This chapter contains the following topics:

| Topic | Page |
|--|--------------------|
| Factory configuration | 18 |
| Application functions | 19 |
| Basic functions | 23 |
| Graphic display terminal option | 24 |
| Graphic display terminal option | 24 |
| Powering up the drive for the first time | 27 |
| Remote display terminal option | 30 |
| Structure of the parameter tables | 31 |
| Finding a parameter in this document | 32 |
| Description of the HMI | 33 |
| Structure of the menus | 34 |

Factory configuration

Factory settings

The Altivar 32 is factory-set for common operating conditions:

- Display: drive ready **[Ready]** (*r d Y*) when motor is ready to run and motor frequency when motor is running.
- The LI3 to LI6 logic inputs, AI2 and AI3 analog inputs, LO1 logic output, AO1 analog output, and R2 relay are unassigned.
- Stop mode when fault detected: freewheel.

| Code | Description | Factory settings values | Page |
|--------------|-------------------------------|--|---------------------|
| <i>b F r</i> | [Standard mot. freq] | [50Hz IEC] | 74 |
| <i>l l l</i> | [2/3 wire control] | [2 wire] (<i>l l l</i>): 2-wire control | 73 |
| <i>l l l</i> | [Motor control type] | [Standard] (<i>l l l</i>): U/F 2 points (Volts/Hz) without internal speed loop | 92 |
| <i>A l l</i> | [Acceleration] | 3.0 seconds | 75 |
| <i>d e l</i> | [Deceleration] | 3.0 seconds | 75 |
| <i>L S P</i> | [Low speed] | 0 Hz | 75 |
| <i>H S P</i> | [High speed] | 50 Hz | 75 |
| <i>I t H</i> | [Mot. therm. current] | Nominal motor current (value depending on drive rating) | 75 |
| <i>S d l</i> | [Auto DC inj. level 1] | 0.7 x nominal drive current, for 0.5 seconds | 81 |
| <i>S F r</i> | [Switching freq.] | 4 kHz | 82 |
| <i>F r d</i> | [Forward] | [LI1] (<i>L I 1</i>): Logic input LI1 | 113 |
| <i>r r S</i> | [Reverse assign.] | [LI2] (<i>L I 2</i>): Logic input LI2 | 113 |
| <i>F r l</i> | [Ref.1 channel] | [AI1] (<i>A I 1</i>): Analog input AI1 | 139 |
| <i>r l</i> | [R1 Assignment] | [No drive fit] (<i>F L t</i>): The contact opens when a fault is detected or when the drive has been switched off | 123 |
| <i>b r R</i> | [Dec ramp adapt.] | [Yes] (<i>Y E S</i>): Function active (automatic adaptation of deceleration ramp) | 157 |
| <i>R t r</i> | [Automatic restart] | [No] (<i>n O</i>): Function inactive | 234 |
| <i>S t t</i> | [Type of stop] | [Ramp stop] (<i>r n P</i>): On ramp | 158 |
| <i>C F G</i> | [Macro configuration] | [Start/Stop] (<i>S t S</i>) | 70 |

Note: If you want to keep the drive presettings to a minimum, select the macro configuration **[Macro configuration]** (*C F G*) = **[Start/stop]** (*S t S*) followed by **[Restore config.]** (*F l S*) = **[Config. CFG]** (*I n l*). For more information, see page [70](#).

Check whether the values above are compatible with the application.

Application functions

The tables on the following pages show the combinations of functions and applications, in order to guide your selection.

The applications in these tables relate to the following machines, in particular:

- **Hoisting:** cranes, overhead cranes, gantries (vertical hoisting, translation, slewing), lifting platforms
- **Handling:** palletizers/depalletizers, conveyors, roller tables
- **Packing:** carton packers, labeling machines
- **Textiles:** weaving looms, carding frames, washing machines, spinners, drawing frames
- **Wood:** automatic lathes, saws, milling
- **Process**

Each machine has its own special features, and the combinations listed here are neither mandatory nor exhaustive.

Some functions are designed specifically for a particular application. In this case, the application is identified by a tab in the margin on the relevant programming pages.

Motor control functions

| Functions | Page | Applications | | | | | |
|---|---------------------|--------------|----------|---------|----------|------|---------|
| | | Hoisting | Handling | Packing | Textiles | Wood | Process |
| V/f ratio | 92 | | ■ | | | ■ | |
| Sensorless flux vector control | 92 | ■ | ■ | ■ | ■ | ■ | ■ |
| 2-point vector control | 92 | ■ | | | ■ | | |
| Open-loop synchronous motor | 92 | | | | ■ | | |
| Output frequency up to 599 Hz | 92 | | | | ■ | ■ | |
| Motor overvoltage limiting | 107 | | | | ■ | ■ | |
| DC bus connection (see Installation manual) | - | | | | ■ | | ■ |
| Motor fluxing using a logic input | 174 | ■ | ■ | ■ | | | |
| Switching frequency of up to 16 kHz | 82 | | | | ■ | ■ | |
| Auto-tuning | 75 | ■ | ■ | ■ | ■ | ■ | ■ |

Functions on speed references

| Functions | Page | Applications | | | | | |
|---|---------------------|--------------|----------|---------|----------|------|---------|
| | | Hoisting | Handling | Packing | Textiles | Wood | Process |
| Differential bipolar reference | 116 | ■ | ■ | ■ | | | |
| Reference delinearization (magnifying glass effect) | 119 | ■ | ■ | | | | |
| Frequency control input | 139 | | | | ■ | | ■ |
| Reference switching | 152 | | | ■ | | | |
| Reference summing | 153 | | | ■ | | | |
| Reference subtraction | 153 | | | ■ | | | |
| Reference multiplication | 153 | | | ■ | | | |
| Adjustable profile ramp | 155 | ■ | ■ | | | | |
| Jog operation | 163 | | ■ | | ■ | | ■ |
| Preset speeds | 165 | ■ | ■ | ■ | | | |
| + speed / - speed using single action pushbuttons (1 step) | 169 | | | | | | ■ |
| + speed / - speed using double action pushbuttons (2 steps) | 169 | ■ | | | | | |
| +/- speed around a reference | 172 | | | | ■ | | ■ |
| Save reference | 173 | | | | | | ■ |

Application-Specific functions

| Functions | Page | Applications | | | | | |
|---|---------------------|--------------|----------|---------|----------|------|---------|
| | | Hoisting | Handling | Packing | Textiles | Wood | Process |
| Fast stop | 158 | | | | | ■ | |
| Brake control | 176 | ■ | ■ | | | | |
| Load measurement | 184 | ■ | | | | | |
| High-speed hoisting | 186 | ■ | | | | | |
| Rope slack | 189 | ■ | | | | | |
| PID regulator | 192 | | | | | | ■ |
| Motor/generator torque limit | 201 | | ■ | | ■ | | ■ |
| Load sharing | 109 | ■ | ■ | | | | |
| Line contactor control | 205 | ■ | ■ | | | ■ | |
| Output contactor control | 208 | ■ | | | | | |
| Positioning by limit switches or sensors | 209 | ■ | ■ | ■ | | | |
| Stop at distance calculated after deceleration limit switch | 211 | | ■ | ■ | | | |
| Parameter switching | 214 | ■ | ■ | ■ | ■ | ■ | ■ |
| Motor or configuration switching | 217 | ■ | ■ | ■ | | | |
| Traverse control | 222 | | | | ■ | | |
| Stop configuration | 158 | | ■ | | ■ | ■ | |
| Function blocks (see dedicated document) | | ■ | ■ | ■ | ■ | ■ | ■ |

Safety functions/Fault management

| Functions | Page | Applications | | | | | |
|--|---------------------|--------------|----------|---------|----------|------|---------|
| | | Hoisting | Handling | Packing | Textiles | Wood | Process |
| Safe Torque Off (STO) (Safety function, see dedicated document) | - | ■ | ■ | ■ | ■ | ■ | ■ |
| Deferred stop on thermal alarm | 240 | ■ | | | | | ■ |
| Alarm handling | 130 | ■ | ■ | ■ | ■ | ■ | ■ |
| Fault management | 232 | ■ | ■ | ■ | ■ | ■ | ■ |
| IGBT tests | 242 | ■ | ■ | ■ | ■ | ■ | ■ |
| Catch a spinning load | 235 | | | | ■ | ■ | |
| Motor protection with PTC probes | 232 | ■ | ■ | ■ | ■ | ■ | ■ |
| Undervoltage management | 241 | | | | ■ | ■ | |
| 4-20 mA loss | 242 | ■ | ■ | | ■ | ■ | ■ |
| Uncontrolled output cut (output phase loss) | 238 | | ■ | | | | |
| Automatic restart | 234 | | ■ | | | | |
| Use of the "Pulse input" input to measure the speed of rotation of the motor | 246 | ■ | ■ | | | | |
| Load variation detection | 248 | ■ | | | | | |
| Underload detection | 251 | | | | | | ■ |
| Overload detection | 253 | | | | | | ■ |
| Safety Integrated functions (see dedicated document) | | | ■ | ■ | ■ | ■ | ■ |

Basic functions

Drive ventilation

The fan starts automatically when the drive thermal state reaches 70% of the maximum thermal state and if the **[Fan Mode]** (*F F n*) is set to **[Standard]** (*S t d*).

Graphic display terminal option

Description of the graphic display terminal

With the graphic display terminal, which works with FLASH V1.1IE26 or higher, it is possible to display more detailed information than can be shown on the integrated display terminal.

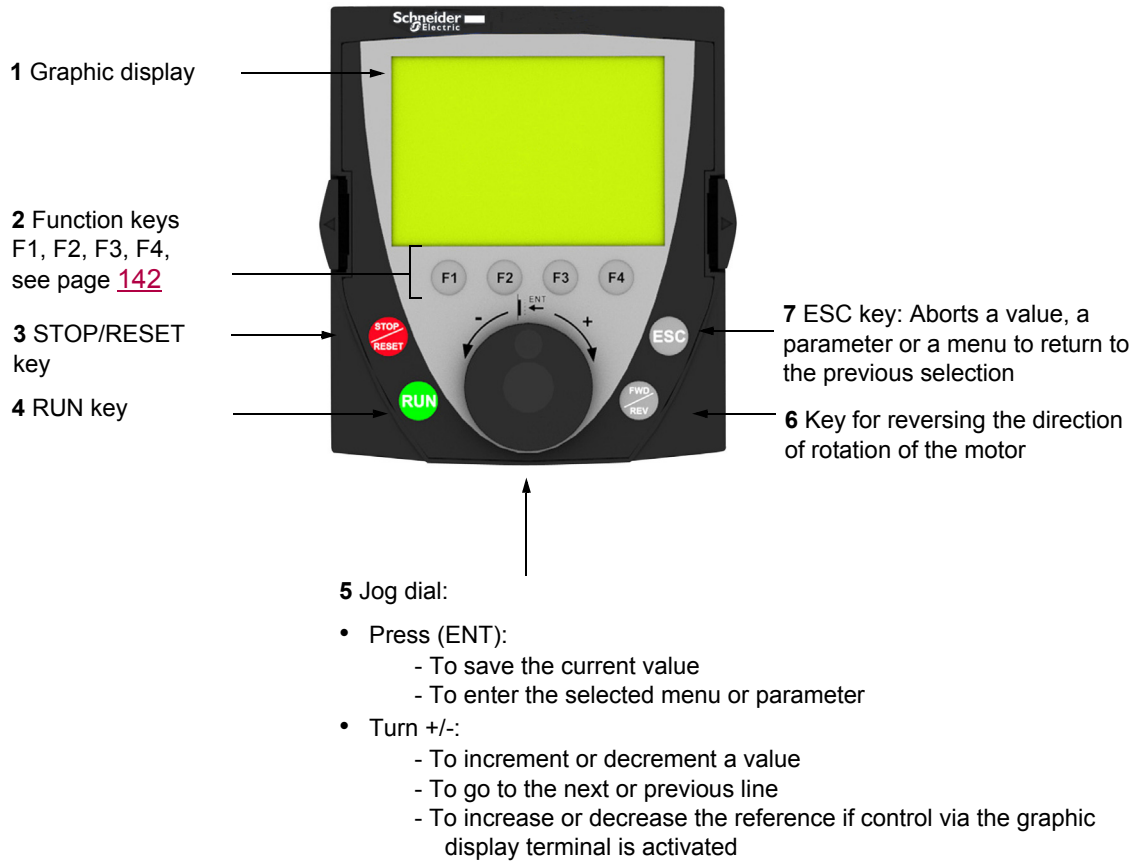

Note: Keys **3**, **4**, **5** and **6** can be used to control the drive directly, if control via the graphic display terminal is activated.

To activate the keys on the remote display terminal, you first have to configure [\[Ref.1 channel\] \(F r I\) = \[HMI\] \(L C C\)](#). For more information, see page [139](#).

Example configuration windows:

Single selection

| | |
|----------|---|
| LANGUAGE | |
| English | |
| Français | ✓ |
| Deutsch | |
| Italiano | |
| Español | |
| Chinese | |
| Русский | |
| Türkçe | |

When powering up the graphic display terminal for the first time, the user has to select the required language.

When only one selection is possible, the selection made is indicated by ✓ .
Example: Only one language can be chosen.

Multiple selection

| | |
|---------------------|-------------------------------------|
| PARAMETER SELECTION | |
| SETTINGS | |
| Ramp increment | <input checked="" type="checkbox"/> |
| Acceleration----- | <input checked="" type="checkbox"/> |
| Deceleration----- | <input type="checkbox"/> |
| Acceleration 2----- | <input type="checkbox"/> |
| Deceleration 2 | |
| Edit | |

When multiple selection is possible, the selections made are indicated by ✓ .
Example: A number of parameters can be chosen to form the **[USER MENU]**.

Example configuration window for one value:

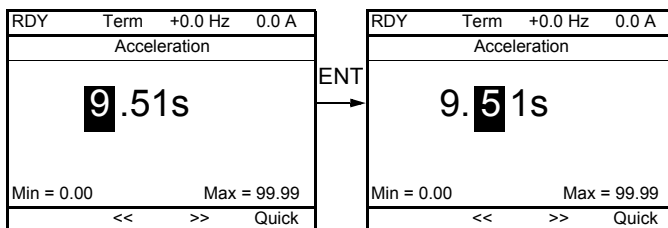

The << and >> arrows (keys F2 and F3) are used to select the digit to be modified, and the jog dial is rotated to increase or decrease this number.

Example visualization of function blocks state:

| | | | | |
|--------------|---|-------------|---------|-------|
| RDY | ⊗ | Term | +0.0 Hz | 0.0 A |
| Acceleration | | | | |
| 9.51s | | | | |
| Min = 0.00 | | Max = 99.99 | | |
| << | | >> | | Quick |

⊗ OFF light: A valid function blocks program is in the ATV32 in stop mode.

⊗ ON light: A valid function blocks program is in the ATV32 in run mode. The drive is considered as being in running state and configuration parameters cannot be modified.

Powering up the drive with Graphic display terminal for the first time

When powering up the graphic display terminal for the first time, the user has to select the required language.

| | |
|----------|---|
| LANGUAGE | |
| English | |
| Français | ✓ |
| Deutsch | |
| Italiano | |
| Español | |
| Chinese | |
| Русский | |
| Türkçe | |

Display after the graphic display terminal has been powered up for the first time. Select the language and press ENT.

↓ ENT

| | |
|---|--|
| Schneider | |
|  | |
| ATV32HU15M2 | |
| 1.5kW/2HP 220V Single | |
| Config. n°0 | |

The drive's rating details will now appear.

↓ 3 seconds

| | | | |
|--------------|------|--------|-------|
| RDY | Term | 0.0 Hz | 0.0 A |
| ACCESS LEVEL | | | |
| Basic | | | |
| Standard | | | ✓ |
| Advanced | | | |
| Expert | | | |

↓ ENT

| | | | |
|---------------------|------|--------|-------|
| RDY | Term | 0.0 Hz | 0.0 A |
| 1 DRIVE MENU | | | |
| 1.1 SPEED REFERENCE | | | |
| 1.2 MONITORING | | | |
| 1.3 CONFIGURATION | | | |
| Code | << | >> | Quick |

Powering up the drive for the first time

With the integrated display terminal, when powering up the drive for the first time, the user immediately accesses to **[Standard mot. freq]** (*b F r*) (see page 74) in the menu (CO nF > FULL > SIM).

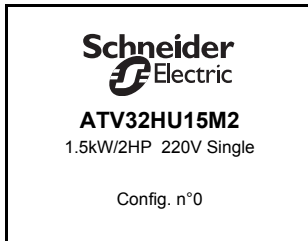

Display after the drive has been powered up for the first time.

↓ 3 seconds

| RDY | Term | 0.0 Hz | 0.0 A |
|--------------|------|--------|-------|
| ACCESS LEVEL | | | |
| Basic | | | |
| Standard | | | |
| Advanced | | | |
| Expert | | | |

The **[ACCESS LEVEL]** screen follows automatically.

↓ ENT

| RDY | Term | 0.0 Hz | 0.0 A |
|---------------------|------|--------|-------|
| 1 DRIVE MENU | | | |
| 1.1 SPEED REFERENCE | | | |
| 1.2 MONITORING | | | |
| 1.3 CONFIGURATION | | | |
| Code | << | >> | Quick |

Automatically switches to the **[1 DRIVE MENU]** menu after 3 seconds. Select the menu and press ENT.

↓ ESC

| MAIN MENU | | | |
|------------------|--|--|--|
| 1 DRIVE MENU | | | |
| 2 IDENTIFICATION | | | |
| 3 INTERFACE | | | |
| 4 OPEN / SAVE AS | | | |
| 5 PASSWORD | | | |

The MAIN MENU appears on the graphic display terminal if you press the ESC key.

Subsequent power-ups

With the integrated display terminal, at subsequent power-ups of the drive for the first time, the user immediately accesses to the drive state (Same list than [\[Drive state\] \(H S I\)](#) page [59](#)). Example : Ready (rdY).

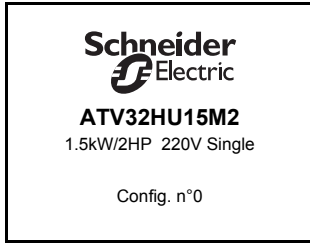

Display after powering up.

↓ 3 seconds

| | | | |
|---------------------|------|--------|-------|
| RDY | Term | 0.0 Hz | 0.0 A |
| 1 DRIVE MENU | | | |
| 1.1 SPEED REFERENCE | | | |
| 1.2 MONITORING | | | |
| 1.3 CONFIGURATION | | | |
| Code | << | >> | Quick |

Automatically switches to the [\[1 DRIVE MENU\]](#) menu after 3 seconds. Select the menu and press ENT.

↓ 10 seconds

| | | | |
|-----------------|------|---------|--------------|
| RDY | Term | +0.0 Hz | 0.0 A |
| Frequency ref. | | | |
| + 1.3 Hz | | | |
| Min = -599.0 | | | Max = +599.0 |
| Quick | | | |

Automatically switches to the monitoring screen after 10 seconds.

Identification menu

The **[IDENTIFICATION]** (**0 Id -**) menu can only be accessed on the graphic display terminal.

This is a read-only menu that cannot be configured. It enables the following information to be displayed:

- Drive reference, power rating and voltage
- Drive software version
- Drive serial number
- Safety function status and checksum
- Function blocks program and catalogue version
- Type of options present, with their software version
- Graphic display terminal type and version

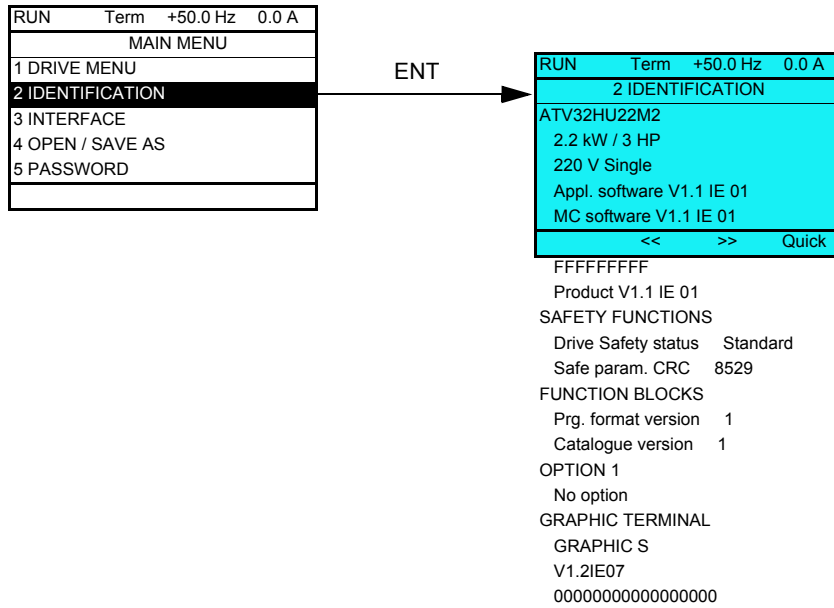

Remote display terminal option

Description of the remote display terminal

This remote display terminal is a local control unit which can be mounted on the door of the wall-mounted or floor-standing enclosure. It has a cable with connectors, which is connected to the drive serial link (see the documentation supplied with the remote display terminal). With this remote display terminal, up and down arrows are used for navigation rather than a jog dial.

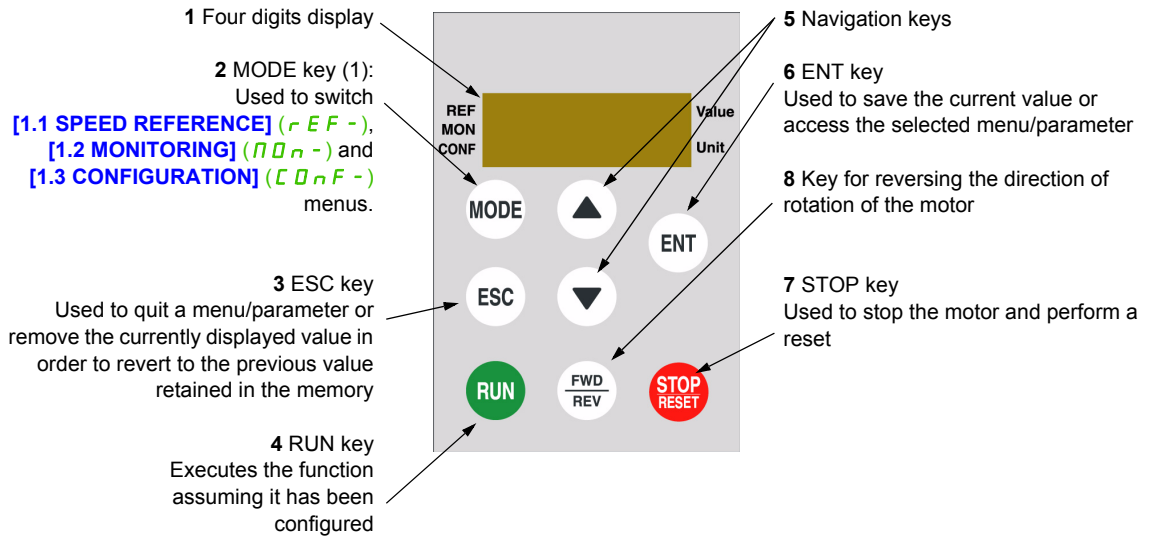

(1) If the drive is locked by a code ([PIN code 1] (C D D) page 282), pressing the MODE key enables you to switch from the [1.2 MONITORING] (M O N -) menu to the [1.1 SPEED REFERENCE] (r E F -) menu and vice versa.

To activate the keys on the remote display terminal, you first have to configure [Ref.1 channel] (F r l) = [HMI] (L C C). For more information, see page 139.

Structure of the parameter tables

The parameter tables contained in the descriptions of the various menus are organized as follows.

Example:

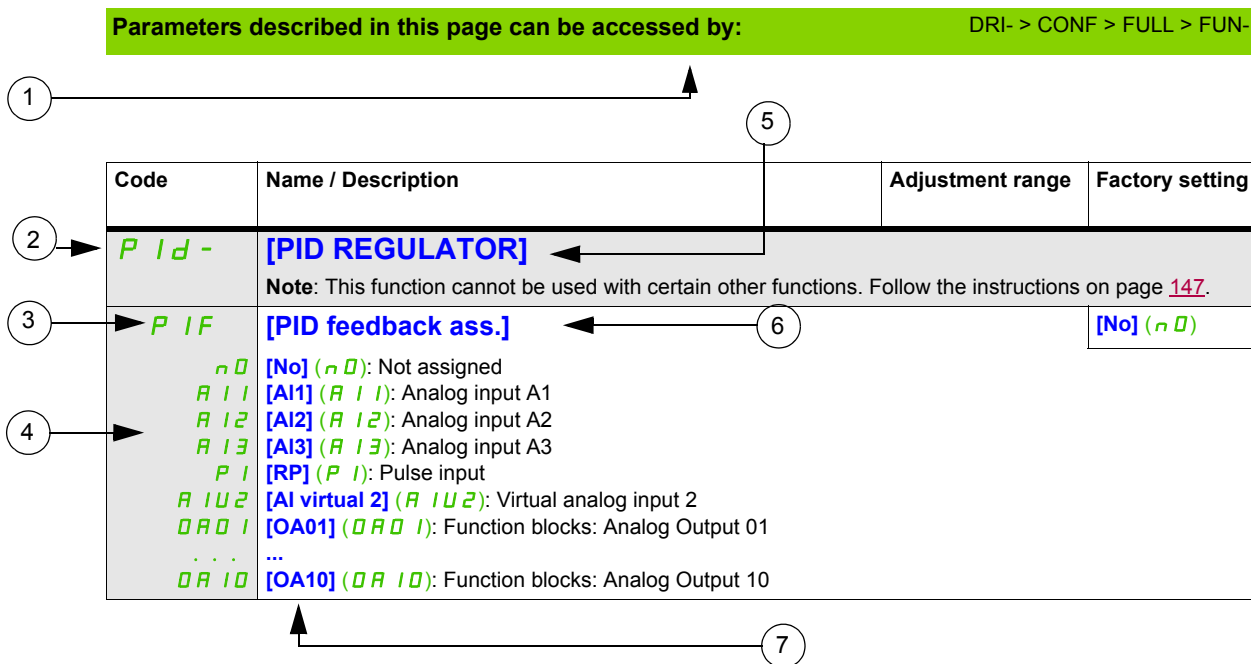

- | | |
|--|---|
| 1. Way to access the parameters described in this page | 5. Name of submenu on graphic display terminal |
| 2. Submenu code on 4-digit 7-segment display | 6. Name of parameter on graphic display terminal |
| 3. Parameter code on 4-digit 7-segment display | 7. Value of parameter on graphic display terminal |
| 4. Parameter value on 4-digit 7-segment display | |

Note: The text in square brackets [] indicates what you will see on the graphic display terminal.

A menu followed by the mention "(continued)" appears sometimes to locate you in the structure.

Example:

| | |
|---------|--|
| F U n - | [APPLICATION FUNCT.] (continued) |
| P I d - | [PID REGULATOR] <small>Note: This function cannot be used with certain other functions. Follow the instructions on page 147.</small> |

In this case, the mention "(continued)" indicates that the [APPLICATION FUNCT.] submenu is above the [PID REGULATOR] submenu in the structure.

A parameter can contain some pictograms. Each pictogram has its legend at the end of the table.

Main pictograms:

- ★

These parameters only appear if the corresponding function has been selected in another menu. When the parameters can also be accessed and adjusted from within the configuration menu for the corresponding function, their description is detailed in these menus, on the pages indicated, to aid programming.
- ↻

Parameter that can be modified during operation or when stopped.
- ⌚ 2 s

To change the assignment of this parameter, press the ENT key for 2 s.

Finding a parameter in this document

The following assistance with finding explanations on a parameter is provided:

- With the integrated display terminal and the remote display terminal: Direct use of the parameter code index, page [301](#), to find the page giving details of the displayed parameter.
- With the graphic display terminal: Select the required parameter and press F1  : **[Code]**. The parameter code is displayed instead of its name while the key is held down.

Example: ACC

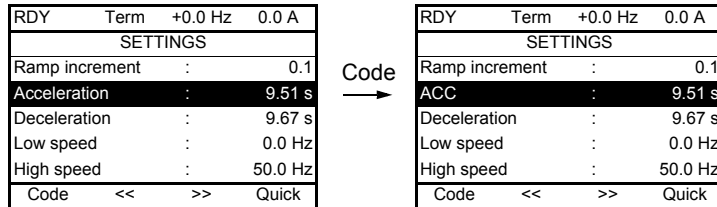

- Then use the parameter code index, page [301](#), to find the page giving details of the displayed parameter.

Description of the HMI

Functions of the Display and the Keys

1 The **ESC** key is used for menu navigation (backward) and parameters adjustment (cancel)

2 The **Jog dial** is used for menu navigation (up or down) and parameters adjustment (increase/decrease value or element choice). It can be used as Virtual analogic input 1 for drive frequency reference.

3 The **ENT** key (push on the Jog dial) is used for menu navigation (forward) and parameters adjustment (validate)

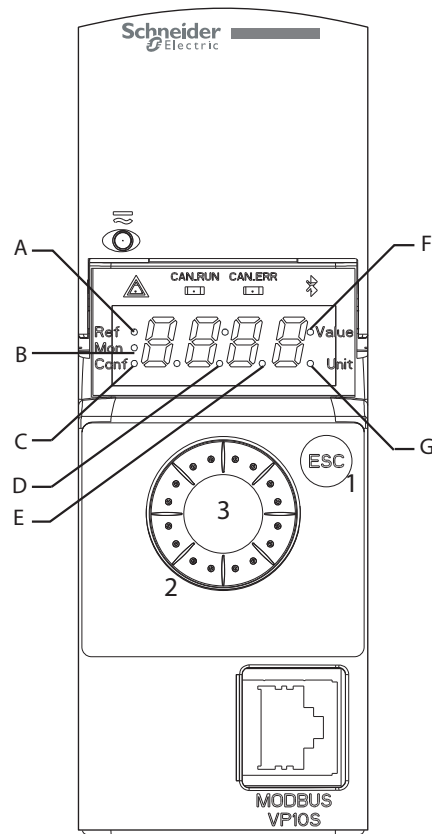

| | | | |
|---|--|---|---|
| A | REF mode selected (<i>r E F -</i>) | E | Dot used to display parameter value (1/10 unit) |
| B | MON mode selected (<i>n D n -</i>) | F | Current display is parameter value |
| C | CONF mode selected (<i>C D n F</i>) | G | Current display is parameter unit |
| D | Dot used to display parameter value (1/100 unit) | | |

Normal display, with no fault code displayed and no startup:

Displays the parameter selected in the [1.2 MONITORING] (*n D n -*) menu (default: [Frequency ref.] (*F r H*)).

- *I n I t*: Initialization sequence (only on remote display terminal)
- *t U n*: AutoTuning
- *d C b*: Injection braking
- *r d Y*: Drive ready
- *n S t*: Freewheel stop control
- *C L l*: Current limit
- *F S t*: Fast stop
- *F L U*: Fluxing function is activated
- *n L P*: Control is powered on but the DC bus is not loaded
- *C t L*: Controlled stop
- *D b r*: Adapted deceleration
- *S O C*: Stand by output cut
- *U S A*: Undervoltage alarm
- *S S l*: Safety SS1 level
- *S L S*: Safety SLS level
- *S t D*: Safety STO level

In the event of a detected fault, the display will flash to notify the user accordingly. If a graphic display terminal is connected, the name of the detected fault will be displayed.

Structure of the menus

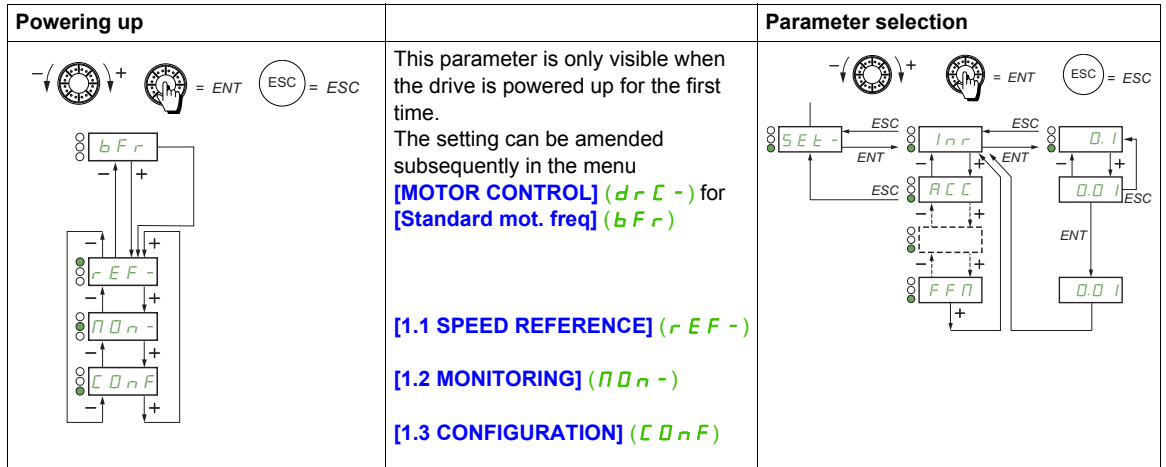

On the 7-segment display, a dash after menu and submenu codes is used to differentiate them from parameter codes.

Example: [APPLICATION FUNCT.] (*F U n -*) menu, [Acceleration] (*A C C*) parameter

Selection of multiple assignments for one parameter

Example: List of group 1 alarms in [INPUTS / OUTPUTS CFG] (*I _ D -*) menu

A number of alarms can be selected by "checking" them as follows.

The digit on the right indicates:

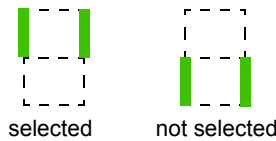

The same principle is used for all multiple selections.

Programming



What's in this Part?

This part contains the following chapters:

| Chapter | Chapter Name | Page |
|---------|---------------------------|---------------------|
| 3 | Reference Mode (rEF) | 37 |
| 4 | Monitoring Mode (MOn) | 41 |
| 5 | Configuration Mode (ConF) | 65 |
| 6 | Interface (ItF) | 261 |
| 7 | Open / Save as (trA) | 277 |
| 8 | Password (COd) | 281 |
| 9 | Multipoint Screen | 283 |

Reference Mode (rEF)

3

What's in this Chapter?

This chapter contains the following topics:

| Topic | Page |
|-------------------|--------------------|
| Introduction | 38 |
| Organization tree | 39 |
| Menu | 40 |

Introduction

Use the reference mode to monitor and, if the reference channel is the analog input 1 (**[Ref.1 channel]** (F r I) page 139 set to **[AI virtual 1]** (R I U I)), adjust the actual reference value by modifying the analog input voltage value.

If local control is enabled (**[Ref.1 channel]** (F r I) page 139 set to **[HMI]** (L C C)), the jog dial on the remote display terminal or the Up/Down Navigation keys on the remote display terminal acts as a potentiometer to change the reference value up and down within the limits preset by other parameters (**[Low speed]** (L S P) or **[High speed]** (H S P)).

There is no need to press the ENT key to confirm the change of the reference.

Organization tree

(1) Depending on the active reference channel

Possible values:

(R I U I)
 (L F r)
 (Π F r)
 (r P I)
 (F r H)
 (r P L)

(2) 2 s or ESC

Displayed parameter value and unit of the diagram are given as examples.

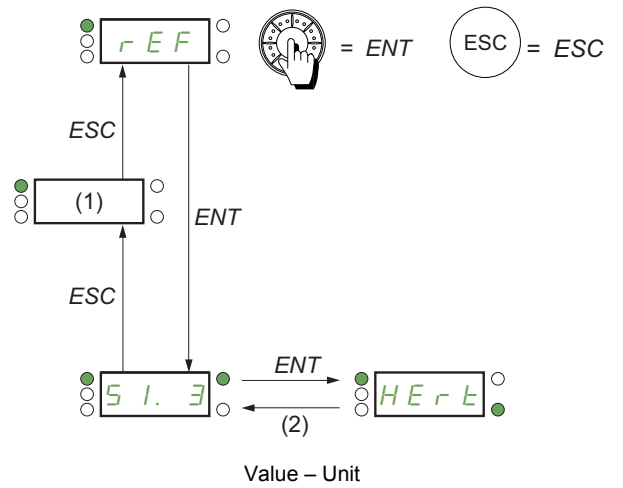

Parameters described in this page can be accessed by:

DRI- > REF-

Menu

| Code | Name / Description | Adjustment range | Factory setting |
|--------------------------|--|----------------------|-----------------|
| <i>dr I-</i> | [1 DRIVE MENU] | | |
| <i>rEF-</i> | [1.1 SPEED REFERENCE] Displayed parameters depend on drive settings. | | |
| <i>RIU I</i> ★ (1) | [Image input AIV1] First virtual AI value. This parameter allows to modify the frequency reference with the embedded jog dial. | 0 to 100% of HSP-LSP | 0% |
| <i>LFr</i> ★ (1) | [HMI Frequency ref.] HMI frequency reference (signed value). This parameter allows to modify the frequency reference with the remote HMI. | -599 to +599 Hz | 0 Hz |
| <i>ΠFr</i> ★ (1) | [Multiplying coeff.] Multiply frequency variable. Multiplying coefficient, can be accessed if [Multiplier ref.] (<i>ΠR2, ΠR3</i>) page 154 has been assigned to the graphic terminal. | 0 to 100% | 100% |
| <i>rPI</i> ★ (1) | [Internal PID ref.] PID: Internal reference PI. This parameter allows to modify the PID internal reference with the jog dial. Internal PID reference is visible if [PID feedback] (<i>P IF</i>) is not set to [No] (<i>rD</i>). | 0 to 32,767 | 150 |
| <i>FrH</i> ★ | [Frequency ref.] Frequency reference before ramp (signed value). Actual frequency reference applied to the motor regardless of which reference channel has been selected. This parameter is in read-only mode. Frequency reference is visible if the command channel is not HMI or virtual AI. | -599 to +599 Hz | - |
| <i>rPC</i> ★ | [PID reference] PID: Setpoint value. PID reference is visible if [PID feedback] (<i>P IF</i>) is not set to [No] (<i>rD</i>). | 0 to 65,535 | - |

(1) It is not necessary to press the ENT key to confirm the modification of the reference.



These parameters only appear if the corresponding function has been selected in another menu. When the parameters can also be accessed and adjusted from within the configuration menu for the corresponding function, their description is detailed in these menus, on the pages indicated, to aid programming.

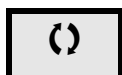

Parameter that can be modified during operation or when stopped.

Monitoring Mode (MOn)



4

What's in this Chapter?

This chapter contains the following topics:

| Topic | Page |
|-------------------|--------------------|
| Introduction | 42 |
| Organization tree | 43 |
| Menu | 44 |

Introduction

The parameters can be accessed when the drive is running or stopped.

Some functions have numerous parameters. In order to clarify programming and avoid having to scroll through endless parameters, these functions have been grouped in submenus. Like menus, submenus are identified by a dash after their code.

When the drive is running, the value displayed is one of the monitoring parameters. By default, the value displayed is the input frequency reference ([Frequency ref.] (F r H) parameter page 44).

While the value of the new monitoring parameter required is being displayed, press a second time on the jog dial key to display the units or press and hold down the jog dial (ENT) again (for 2 seconds) to confirm the change of monitoring parameter and store it. From then on, it is the value of this parameter that will be displayed during operation (even after powering down).

Unless the new choice is confirmed by pressing and holding down ENT again, the display will revert to the previous parameter after powering down.

Note: After the drive has been turned off or following a loss of line supply, the parameter displayed is the drive status (example: [Ready] (r d Y)). The selected parameter is displayed following a run command.

Organization tree

Displayed parameters of the diagram are given as examples.

(1) Visible only with graphic display terminal

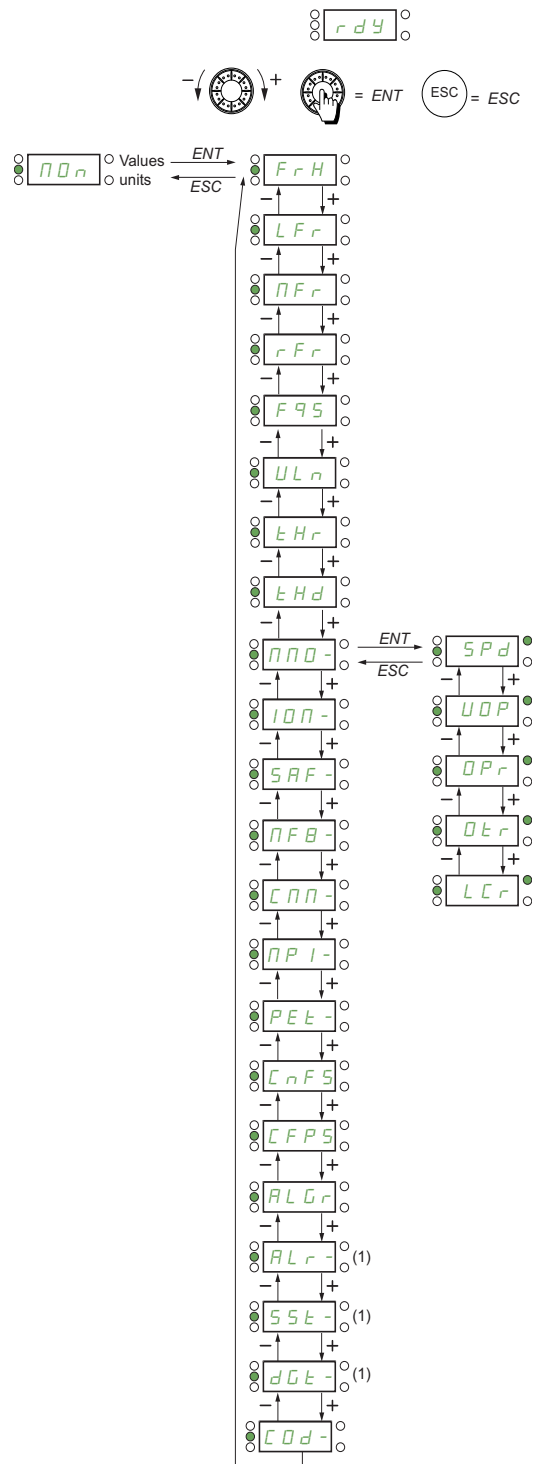

Parameters described in this page can be accessed by:

DRI- > MON-

Menu

| Code | Name / Description | Unit |
|--|--|------|
| ΠΠΠ - | [1.2 MONITORING] | |
| A I U I () | [Image input AIV1] First virtual AI value. This parameter is read-only. It enables you to display the speed reference applied to the motor. | % |
| F r H | [Frequency ref.] Frequency reference before ramp (signed value). This parameter is read-only. It enables you to display the speed reference applied to the motor, regardless of which reference channel has been selected. | Hz |
| L F r | [HMI Frequency ref.] HMI frequency reference (signed value). This parameter only appears if the function has been enabled. It is used to change the speed reference from the remote control. ENT does not have to be pressed to enable a change of reference. | Hz |
| Π F r ★ () | [Multiplying coeff.] Multiply frequency variable. Multiplying coefficient, can be accessed if [Multiplier ref. -] (ΠΑ2, ΠΑ3) page 154 has been assigned. | % |
| r F r | [Output frequency] Estimated motor frequency (signed value). | Hz |
| F 9 5 ★ | [Pulse in. work. freq.] Measured frequency of the "Pulse input" input (see page 246). | Hz |
| U L n | [Mains voltage] Main voltage (from DC bus). Line voltage based on DC bus measurement, motor running or stopped. | V |
| t H r | [Motor thermal state] Motor thermal state. 100% = Nominal thermal state, 118% = "OLF" threshold (motor overload). | % |
| t H d | [Drv.thermal state] Drive thermal state. 100% = Nominal thermal state, 118% = "OHF" threshold (drive overload). | % |
| ΠΠΠ - | [MONIT. MOTOR] | |
| S P d | [Motor speed] Motor speed in rpm. | rpm |
| U O P | [Motor voltage] Motor voltage. | V |
| 0 P r | [Motor power] Output power monitoring (100% = nominal motor power). | % |
| 0 t r | [Motor torque] Output torque value (100% = nominal motor torque). | % |
| L C r | [Motor current] Estimated motor current. | A |

Parameters described in this page can be accessed by:

DRI- > MON- > IOM- > LIA-

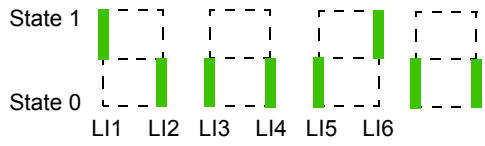
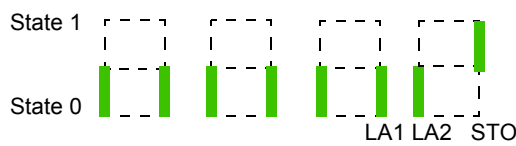
| Code | Name / Description | Unit |
|--|---|------|
| Π 0 n - | [1.2 MONITORING] (continued) | |
| 1 0 n - | [I/O MAP] | |
| L 1 A - | [LOGIC INPUT CONF.] Logic input functions. | |
| L 1 A | [LI1 assignment] Read-only parameters, cannot be configured. It displays all the functions that are assigned to the logic input in order to check for multiple assignments. If no functions have been assigned, [No] (n D) is displayed. Use the jog dial to scroll through the functions. The use of graphic display terminal allows to see the delay [LI1 On Delay] (L 1 d) . Possible values are the same than in configuration menu page 114 . | |
| L 2 A to L 6 A L A 1 A L A 2 A | [L-- assignment] All the logic inputs available on the drive are processed as in the example for LI1 above. | |
| L 1 5 1 | [State of logic inputs LI1 to LI6] Can be used to visualize the state of logic inputs LI1 to LI6 (display segment assignment: high = 1, low = 0).  Example above: LI1 and LI6 are at 1; LI2 to LI5 are at 0. | |
| L 1 5 2 | [State of Safe Torque Off] Can be used to visualize the state of LA1, LA2 and STO (Safe Torque Off) (display segment assignment: high = 1, low = 0).  Example above: LA1 and LA2 are at 0; STO (Safe Torque Off) is at 1. | |

Parameters described in this page can be accessed by:

DRI- > MON- > IOM- > AIA-

| Code | Name / Description | Unit |
|----------------|--|------|
| A I A - | [ANALOG INPUTS IMAGE] Analog input functions. | |
| A I I C | [AI1] AI1 customer image: Value of analog input 1. | V |
| A I I A | [AI1 assignment] AI1 functions assignment. If no functions have been assigned, [No] (n D) is displayed. Following parameters are visible on the graphic display terminal by pressing the ENT key on the parameter. n D [No] (n D) : Not assigned F r 1 [Ref.1 channel] (F r 1) : Reference source 1 F r 2 [Ref.2 channel] (F r 2) : Reference source 2 S A 2 [Summing ref. 2] (S A 2) : Summing reference 2 P I F [PID feedback] (P I F) : PI feedback (PI control) L A A [Torque limitation] (L A A) : Torque limitation: Activation by an analog value d A 2 [Subtract. ref. 2] (d A 2) : Subtracting reference 2 P I n [Manual PID ref.] (P I n) : Manual speed reference of the PI(D) regulator (auto-man) F P I [PID speed ref.] (F P I) : Speed reference of the PI(D) regulator (predictive reference) S A 3 [Summing ref. 3] (S A 3) : Summing reference 3 F r 1 b [Ref.1B channel] (F r 1 b) : Reference source 1B d A 3 [Subtract. ref. 3] (d A 3) : Subtracting reference 3 F L O C [Forced local] (F L O C) : Forced local reference source n A 2 [Ref. 2 multiplier] (n A 2) : Multiplying reference 2 n A 3 [Ref. 3 multiplier] (n A 3) : Multiplying reference 3 P E S [Weight input] (P E S) : External weight measurement function I A 0 1 (I A 0 1) : Functions blocks: Analog Input 01 ... I A 1 0 (I A 1 0) : Functions blocks: Analog Input 10 | |
| U I L 1 | [AI1 min value] Voltage scaling parameter of 0%. | V |
| U I H 1 | [AI1 max value] Voltage scaling parameter of 100%. | V |
| A I I F | [AI1 filter] Interference filtering cut-off time of the low-filter. | s |
| A I A - | [ANALOG INPUTS IMAGE] (continued) Analog input functions. | |
| A I 2 C | [AI2] AI2 customer image: Value of analog input 2. | V |
| A I 2 A | [AI2 assignment] AI2 functions assignment. If no functions have been assigned, [No] (n D) is displayed. Following parameters are visible on the graphic display terminal by pressing the ENT key on the parameter. Identical to [AI1 assignment] (A I I A) page 46. | |
| U I L 2 | [AI2 min value] Voltage scaling parameter of 0%. | V |
| U I H 2 | [AI2 max value] Voltage scaling parameter of 100%. | V |
| A I 2 F | [AI2 filter] Interference filtering cutoff time of the low-filter. | s |

Parameters described in this page can be accessed by:

DRI- > MON- > IOM- > AIA- > AI3C

| Code | Name / Description | Unit |
|---------------------|--|------|
| A I A - | [ANALOG INPUTS IMAGE] (continued) Analog input functions. | |
| A I 3 C | [AI3] AI3 customer image: Value of analog input 3. | V |
| A I 3 A | [AI3 assignment] AI3 functions assignment. If no functions have been assigned, [No] (nD) is displayed. Following parameters are visible on the graphic display terminal by pressing the ENT key on the parameter. Identical to [AI1 assignment] (A I 1 A) page 46. | |
| C r L 3 | [AI3 min value] Current scaling parameter of 0%. | mA |
| C r H 3 | [AI3 max value] Current scaling parameter of 100%. | mA |
| A I 3 F | [AI3 filter] Interference filtering cutoff time of the low-filter. | s |
| I O N - | [I/O MAP] (continued) | |
| A O A - | [ANALOG OUTPUTS IMAGE] Analog output functions. Following parameters are visible on the graphic display terminal by pressing the ENT key on the parameter. | |
| A O 1 C ⌚ | [AO1C] AO1 customer image: Value of analog output 1. | |
| A O 1 | [AO1 assignment] AO1 functions assignment. If no functions have been assigned, [No] (nD) is displayed. Identical to [AO1 assignment] (A O 1) page 129. | |
| U O L 1 ★ | [AO1 min Output] Voltage scaling parameter of 0%. Can be accessed if [AO1 Type] (A O 1 E) is set to [Voltage] (I O U) . | V |
| U O H 1 ★ | [AO1 max Output] Voltage scaling parameter of 100%. Can be accessed if [AO1 Type] (A O 1 E) is set to [Voltage] (I O U) . | V |
| A O L 1 ★ | [AO1 min output] Current scaling parameter of 0%. Can be accessed if [AO1 Type] (A O 1 E) is set to [Current] (O A) . | mA |
| A O H 1 ★ | [AO1 max output] Current scaling parameter of 100%. Can be accessed if [AO1 Type] (A O 1 E) is set to [Current] (O A) . | mA |
| A 5 L 1 | [Scaling AO1 max] Minimum scaling value for AO1. | % |
| A 5 H 1 | [Scaling AO1 min] Maximum scaling value for AO1. | % |
| A O 1 F | [AO1 filter] Cutoff time of the low-filter. | s |

Parameters described in this page can be accessed by:

DRI- > MON- > IOM- > FSI-

| Code | Name / Description | Unit |
|----------------|---|------|
| I O P - | [I/O MAP] (continued) | |
| F S I - | [FREQ. SIGNAL IMAGE] Frequency signal image. This menu is visible only on graphic display terminal. | |
| P F r C | [RP input] Filtered customer pulse input frequency reference. Following parameters are visible on the graphic display terminal by pressing the ENT key on the parameter. | Hz |
| P I A | [RP assignment] Pulse input assignment. If no functions have been assigned, [No] (n D) is displayed. Identical to [AI1 assignment] (A I I A) page 46. | |
| P I L | [RP min value] RP minimum value. Pulse input scaling parameter of 0%. | kHz |
| P F r | [RP max value] RP maximum value Pulse input scaling parameter of 100%. | kHz |
| P F I | [RP filter] Interference filtering pulse input cutoff time of the low-filter. | ms |
| P O n - | [1.2 MONITORING] (continued) | |
| S A F - | [MONIT. SAFETY] For more details on Integrated Safety Functions, please refer to dedicated Safety manual. | |
| S t O S | [STO status] Status of the Safe Torque Off safety function. | |
| I d L E | [Idle] (I d L E) : STO not in progress | |
| S t O | [Safe stop] (S t O) : STO in progress | |
| F L t | [Fault] (F L t) : STO fault detected | |
| S L S S | [SLS status] Status of the Safe Limit speed safety function. | |
| n D | [Not config.] (n D) : SLS not configured | |
| I d L E | [Idle] (I d L E) : SLS not in progress | |
| S S I | [Safe ramp] (S S I) : SLS ramp in progress | |
| S L S | [Speed limited] (S L S) : SLS speed limitation in progress | |
| S t O | [Safe stop] (S t O) : SLS safe torque off request in progress | |
| F L t | [Fault] (F L t) : SLS fault detected | |
| S S I S | [SS1 status] Status of the Safe Stop 1 safety function. | |
| n D | [Not config.] (n D) : SS1 not configured | |
| I d L E | [Idle] (I d L E) : SS1 not in progress | |
| S S I | [Safe ramp] (S S I) : SS1 ramp in progress | |
| S t O | [Safe stop] (S t O) : SS1 safe torque off request in progress | |
| F L t | [Fault] (F L t) : SS1 fault detected | |

Parameters described in this page can be accessed by:

DRI- > MON- > SAF-

| Code | Name / Description | Unit |
|---------------------|---|------|
| S F F E | <p>[Safety fault reg.] Safety function detected fault error register.</p> <p>Bit 0 = 1: Logical Input debounce time out Bit 1: Reserved Bit 2 = 1: Motor speed sign changed during SS1 stop Bit 3 = 1: Motor speed reached SS1 trip area Bit 4: Reserved Bit 5: Reserved Bit 6 = 1: Motor speed sign changed during SLS Safe Limitation Bit 7 = 1: Motor speed reached SLS trip area Bit 8: Reserved Bit 9: Reserved Bit 10: Reserved Bit 11: Reserved Bit 12: Reserved Bit 13 = 1: Motor speed measurement is not possible Bit 14 = 1: Motor ground short circuit detected Bit 15 = 1: Motor phase to phase short circuit detected</p> | |
| n D n - | [1.2 MONITORING] (continued) | |
| n F b - | <p>[MONIT. FUN. BLOCKS] For more details on Function Blocks, please refer to dedicated Function Blocks manual.</p> | |
| F b S t | <p>[FB status] Function Block Status.</p> <p>IdLE [Idle] (IdLE): Idle state CHEC [Check prog.] (CHEC): Check program state StOP [Stop] (StOP): STOP state InIt [Init] (InIt): Initialization state rUn [Run] (rUn): RUN state Err [Err] (Err): Error state</p> | |
| F b F t | <p>[FB fault] Status of the function blocks execution.</p> <p>nD [No] (nD): No fault detected InIt [Internal] (InIt): Internal fault detected bIn [Binary file] (bIn): Binary fault detected InP [Intern para.] (InP): Internal parameter fault detected PAR [Para. RW] (PAR): Parameter access fault detected CAL [Calculation] (CAL): Calculation fault detected tOAU [TO AUX] (tOAU): TimeOut AUX task tOPP [TO synch] (tOPP): TimeOut in PRE/POST task AdL [Bad ADLC] (AdL): ADLC with bad parameter In [Input assign.] (In): Input not configured</p> | |
| F b I - | [FB IDENTIFICATION] | |
| b U E r ★ | <p>[Program version] Program user version. Can be accessed if [FB status] (F b S t) is not set to [Idle] (IdLE).</p> | |
| b n S ★ | <p>[Program size] Program file size. Can be accessed if [FB status] (F b S t) is not set to [Idle] (IdLE).</p> | |
| b n U | <p>[Prg. format version] Binary format version of the drive. Can be accessed if [FB status] (F b S t) is not set to [Idle] (IdLE).</p> | |
| C t U | <p>[Catalogue version] Catalog version of the drive.</p> | |

Parameters described in this page can be accessed by:

DRI- > MON- > CMM-

| Code | Name / Description | Unit |
|----------------|--|------|
| Π 0 n - | [1.2 MONITORING] (continued) | |
| Σ Π Π - | [COMMUNICATION MAP] This menu is visible only on graphic display terminal, except for [COM. SCANNER INPUT MAP] (15 Π -) and [COM SCAN MAP] (05 Π -) menus. | |
| Σ Π d Σ | [Command channel] Active command channel. | |
| ε Ε r Π | [Terminals] (ε Ε r Π): Terminals | |
| Η Π I | [HMI] (Η Π I): Graphic display terminal or remote display terminal | |
| Π d b | [Modbus] (Π d b): Integrated Modbus | |
| Σ Π n | [CANopen] (Σ Π n): Integrated CANopen® | |
| ε U d | [+/- speed] (ε U d): +/- speed command | |
| n E ε | [Com. card] (n E ε): Communication card (if inserted) | |
| P 5 | [PC tool] (P 5): PC software | |
| Σ Π d | [Cmd value] DRIVECOM command register value. [Profile] (Σ Η Σ F) is not set to [I/O profile] (I O) , see page 139 . Possible values in CiA402 profile, separate or not separate mode. Bit 0: "Switch on"/Contactor command Bit 1: "Disable voltage"/Authorization to supply AC power Bit 2: "Quick stop"/Emergency stop Bit 3: "Enable operation"/Run command Bit 4 to Bit 6: Reserved (set to 0) Bit 7: "Fault reset"/Fault acknowledgment active on 0 to 1 rising edge Bit 8: Halt Stop according to the [Type of stop] (5 ε ε) parameter without leaving the Operation enabled state Bit 9: Reserved (set to 0) Bit 10: Reserved (set to 0) Bit 11 to Bit 15: Can be assigned to a command Possible values in the I/O profile. On state command [2 wire] (ε Σ) . Bit 0: Forward (on state) command = 0: No forward command = 1: Forward command The assignment of bit 0 cannot be modified. It corresponds to the assignment of the terminals. It can be switched. Bit 0 (Σ d d d) is only active if the channel of this control word is active. Bit 1 to Bit 15: Can be assigned to commands. On edge command [3 wire] (ε Σ) . Bit 0: Stop (run authorization). = 0: Stop = 1: Run is authorized on a forward or reverse command Bit 1: Forward (on 0 to 1 rising edge) command The assignment of bits 0 and 1 cannot be modified. It corresponds to the assignment of the terminals. It can be switched. Bits 0 (Σ d d d) and 1 (Σ d d I) are only active if the channel of this control word is active. Bit 2 to Bit 15: Can be assigned to commands | |
| r F Σ Σ | [Active ref. channel] HMI reference channel. | |
| ε Ε r Π | [Terminals] (ε Ε r Π): Terminals | |
| L O C | [Local] (L O C): Jog dial | |
| Η Π I | [HMI] (Η Π I): Graphic display terminal or remote display terminal | |
| Π d b | [Modbus] (Π d b): Integrated Modbus | |
| Σ Π n | [CANopen] (Σ Π n): Integrated CANopen® | |
| ε U d | [tUd] (ε U d): +/- speed command | |
| n E ε | [Com. card] (n E ε): Communication card (if inserted) | |
| P 5 | [PC tool] (P 5): PC software | |
| F r H | [Frequency ref.] Frequency reference before ramp. | Hz |

| Code | Name / Description | Unit |
|-------|---|------|
| E L A | <p>[ETA state word] DRIVECOM status word.</p> <p>Possible values in CiA402 profile, separate or not separate mode. Bit 0: "Ready to switch on", awaiting power section line supply Bit 1: "Switched on", ready Bit 2: "Operation enabled", running Bit 3: "Fault" = 0: No fault = 1: Fault Bit 4: "Voltage enabled", power section line supply present = 0: Power section line supply absent = 1: Power section line supply present When the drive is powered by the power section only, this bit is always at 1. Bit 5: Quick stop/Emergency stop Bit 6: "Switched on disabled", power section line supply locked Bit 7: Alarm = 0: No alarm = 1: Alarm Bit 8: Reserved (= 0) Bit 9: Remote: command or reference via the network = 0: Command or reference via the graphic display terminal or the remote display terminal = 1: Command or reference via the network Bit 10: Target reference reached = 0: The reference is not reached = 1: The reference has been reached When the drive is in speed mode, this is the speed reference. Bit 11: "Internal limit active", reference outside limits = 0: The reference is within the limits = 1: The reference is not within the limits When the drive is in speed mode, the limits are defined by the [Low speed] (L S P) and [High speed] (H S P) parameters. Bit 12 and Bit 13: Reserved (= 0) Bit 14: "Stop key", STOP via stop key = 0: STOP key not pressed = 1: Stop triggered by the STOP key on the graphic display terminal or the remote display terminal Bit 15: "Direction", direction of rotation = 0: Forward rotation at output = 1: Reverse rotation at output</p> <p>The combination of bits 0, 1, 2, 4, 5 and 6 defines the state in the DSP 402 state chart (see the Communication manuals).</p> <p>Possible values in the I/O profile. Note: The value is identical in the CiA402 profile and the I/O profile. In the I/O profile, the description of the values is simplified and does not refer to the CiA402 (Drivecom) state chart. Bit 0: Reserved (= 0 or 1) Bit 1: Ready = 0: Not ready = 1: Ready Bit 2: Running = 0: The drive will not start if a reference other than zero is applied. = 1: Running, if a reference other than zero is applied, the drive can start. Bit 3: Fault = 0: No fault = 1: Fault Bit 4: Power section line supply present = 0: Power section line supply absent = 1: Power section line supply present Bit 5: Reserved (= 1) Bit 6: Reserved (= 0 or 1) Bit 7: Alarm = 0: No alarm = 1: Alarm Bit 8: Reserved (= 0) Bit 9: Command via a network = 0: Command via the terminals or the graphic display terminal = 1: Command via a network</p> | |

Parameters described in this page can be accessed by:

DRI- > MON- > CMM-

| Code | Name / Description | Unit |
|-------------|---|------|
| | Bit 10: Reference reached = 0: The reference is not reached = 1: The reference has been reached Bit 11: Reference outside limits = 0: The reference is within the limits = 1: The reference is not within the limits When the drive is in speed mode, the limits are defined by LSP and HSP parameters. Bit 12 and Bit 13: Reserved (= 0) Bit 14: Stop via STOP key = 0: STOP key not pressed = 1: Stop triggered by the STOP key on the graphic display terminal or the remote display terminal Bit 15: Direction of rotation = 0: Forward rotation at output = 1: Reverse rotation at output | |
| Пнд- | [MODBUS NETWORK DIAG] Modbus network diagnostic. | |
| Пдб1 | [COM LED] View of the Modbus Communication. | |
| П1Сб | [Mb NET frames nb.] Modbus network frame counter: Number of processed frames. | |
| П1ЕС | [Mb NET CRC errors] Modbus network CRC error counter: Number of CRC errors. | |
| СПП- | [COMMUNICATION MAP] (continued) | |
| дбб- | [DIAG BLUETOOTH] Bluetooth network diagnostic. | |
| Пдб2 | [COM LED] View of the Bluetooth Communication Led on integrated display. Led Off: The Bluetooth channel is deactivated. Led fixed On: The bluetooth channel is activated with active connection. Led blinking: The bluetooth channel is activated without active connection. | |
| П3Сб | [Frame Nb] Bluetooth frame counter: Number of processed frames. | |
| П3ЕС | [CRC error Nb] Bluetooth CRC error counter: Number of CRC errors. | |
| СПП- | [COMMUNICATION MAP] (continued) | |
| 15А- | [COM. SCANNER INPUT MAP] Used for CANopen® and Modbus Network. | |
| пп1 | [Com Scan In1 val.] Value of the 1st input word. | |
| пп2 | [Com Scan In2 val.] Value of the 2nd input word. | |
| пп3 | [Com Scan In3 val.] Value of the 3rd input word. | |
| пп4 | [Com Scan In4 val.] Value of the 4th input word. | |
| пп5 | [Com Scan In5 val.] Value of the 5th input word. | |
| пп6 | [Com Scan In6 val.] Value of the 6th input word. | |
| пп7 | [Com Scan In7 val.] Value of the 7th input word. | |
| пп8 | [Com Scan In8 val.] Value of the 8th input word. | |

Parameters described in this page can be accessed by:

DRI- > MON- > CMM- > OSA-

| Code | Name / Description | Unit |
|---------------------|--|------|
| C 0 0 - | [COMMUNICATION MAP] (continued) | |
| D 5 A - | [COM SCAN OUTPUT MAP] | |
| n C 1 | [Com Scan Out1 val.] Value of the 1st output word. | |
| n C 2 | [Com Scan Out2 val.] Value of the 2nd output word. | |
| n C 3 | [Com Scan Out3 val.] Value of the 3rd output word. | |
| n C 4 | [Com Scan Out4 val.] Value of the 4th output word. | |
| n C 5 | [Com Scan Out5 val.] Value of the 5th output word. | |
| n C 6 | [Com Scan Out6 val.] Value of the 6th output word. | |
| n C 7 | [Com Scan Out7 val.] Value of the 7th output word. | |
| n C 8 | [Com Scan Out8 val.] Value of the 8th output word. | |
| C 0 0 - | [COMMUNICATION MAP] (continued) | |
| C 1 - | [CMD. WORD IMAGE] Command word image: Only accessible via graphic display terminal. | |
| C 0 d 1 | [Modbus cmd.] Modbus command word image. | |
| C 0 d 2 | [CANopen cmd.] CANopen® command word image. | |
| C 0 d 3 | [COM. card cmd.] Communication card command word image. | |
| C 0 0 - | [COMMUNICATION MAP] (continued) | |
| r 1 - | [FREQ. REF. WORD MAP] Frequency reference image: Only accessible via graphic display terminal. | |
| L F r 1 | [Modbus ref.] Modbus frequency reference image. | Hz |
| L F r 2 | [CANopen ref.] CANopen® frequency reference image. | Hz |
| L F r 3 | [Com. card ref.] Communication card frequency reference image. | Hz |
| C 0 0 - | [COMMUNICATION MAP] (continued) | |
| C n 0 - | [CANopen MAP] CANopen® image: Only accessible via graphic display terminal. | |
| C 0 n | [RUN LED] View of the CANopen® RUN Led Status. | |
| C A n E | [ERR LED] View of the CANopen® Error Led Status. | |
| P 0 1 - | [PDO1 IMAGE] View of the RPDO1 and TPDO1. | |
| r P 1 1 ★ | [Received PDO1-1] First frame of the received PDO1. | |

Parameters described in this page can be accessed by:

DRI- > MON- > CMM- > CNM- > P01-

| Code | Name / Description | Unit |
|---------------------|---|------|
| <i>r P 12</i> ★ | [Received PDO1-2] Second frame of the received PDO1. | |
| <i>r P 13</i> ★ | [Received PDO1-3] Third frame of the received PDO1. | |
| <i>r P 14</i> ★ | [Received PDO1-4] Fourth frame of the received PDO1. | |
| <i>t P 11</i> ★ | [Transmit PDO1-1] First frame of the transmit PDO1. | |
| <i>t P 12</i> ★ | [Transmit PDO1-2] Second frame of the transmit PDO1. | |
| <i>t P 13</i> ★ | [Transmit PDO1-3] Third frame of the transmit PDO1. | |
| <i>t P 14</i> ★ | [Transmit PDO1-4] Fourth frame of the transmit PDO1. | |
| <i>C n Π -</i> | [CANopen MAP] (continued) CANopen® image: Only accessible via graphic display terminal. | |
| <i>P 0 2 -</i> | [PDO2 IMAGE] View of the RPDO2 and TPDO2: Same structure as [PDO1 IMAGE] (<i>P 0 1 -</i>). | |
| <i>r P 2 1</i> ★ | [Received PDO2-1] First frame of the received PDO2. | |
| <i>r P 2 2</i> ★ | [Received PDO2-2] Second frame of the received PDO2. | |
| <i>r P 2 2</i> ★ | [Received PDO2-3] Third frame of the received PDO2. | |
| <i>r P 2 3</i> ★ | [Received PDO2-4] Fourth frame of the received PDO2. | |
| <i>t P 2 1</i> ★ | [Transmit PDO2-1] First frame of the transmit PDO2. | |
| <i>t P 2 2</i> ★ | [Transmit PDO2-2] Second frame of the transmit PDO2. | |
| <i>t P 2 3</i> ★ | [Transmit PDO2-3] Third frame of the transmit PDO2. | |
| <i>t P 2 4</i> ★ | [Transmit PDO2-4] Fourth frame of the transmit PDO2. | |

| Code | Name / Description | Unit |
|---------------------|---|------|
| <i>C n Π -</i> | [CANopen MAP] (continued) CANopen® image: Only accessible via graphic display terminal. | |
| <i>P 0 3 -</i> | [PDO3 IMAGE] View of the RPDO3 and TPDO3: Same structure as [PDO1 IMAGE] (<i>P 0 1 -</i>). | |
| <i>r P 3 1</i> ★ | [Received PDO3-1] First frame of the received PDO3. | |
| <i>r P 3 2</i> ★ | [Received PDO3-2] Second frame of the received PDO3. | |
| <i>r P 3 3</i> ★ | [Received PDO3-3] Third frame of the received PDO3. | |
| <i>r P 3 3</i> ★ | [Received PDO3-4] Fourth frame of the received PDO3. | |
| <i>t P 3 1</i> ★ | [Transmit PDO3-1] First frame of the transmit PDO3. | |
| <i>t P 3 2</i> ★ | [Transmit PDO3-2] Second frame of the transmit PDO3. | |
| <i>t P 3 3</i> ★ | [Transmit PDO3-3] Third frame of the transmit PDO3. | |
| <i>t P 3 4</i> ★ | [Transmit PDO3-4] Fourth frame of the transmit PDO3. | |
| <i>C n Π -</i> | [CANopen MAP] (continued) CANopen® image: Only accessible via graphic display terminal. | |
| <i>n Π t 5</i> | [Canopen NMT state] Drive NMT State of the CANopen® slave. <i>b 0 0 t</i> [Boot] (<i>b 0 0 t</i>): Bootup <i>s t o p</i> [Stopped] (<i>s t o p</i>): Stopped <i>o p e</i> [Operation] (<i>o p e</i>): Operational <i>p o p e</i> [Pre-op] (<i>p o p e</i>): Pre-Operational | |
| <i>n b t P</i> | [Number of TX PDO] Number of transmit PDO. | |
| <i>n b r P</i> | [Number of RX PDO] Number of receive PDO. | |
| <i>E r C 0</i> | [Error code] CANopen® error register (from 1 to 5). | |
| <i>r E C 1</i> | [RX Error Counter] Controller Rx error counter (not memorized at power off). | |
| <i>t E C 1</i> | [TX error counter] Controller Tx error counter (not memorized at power off). | |

Parameters described in this page can be accessed by:

DRI- > MON- > MPI-

| Code | Name / Description | Unit |
|--------------------------|---|--------------|
| Π 0 n - | [1.2 MONITORING] (continued) | |
| Π P I - ★ | [MONIT. PI] PID management. Visible if [PID feedback ass.] (P I F) is not set to [No] (n 0) . | |
| r P I (↻) ★ | [Internal PID ref.] Internal PID reference: As a process value. | |
| r P E ★ | [PID error] PID error value. | |
| r P F ★ | [PID feedback] PID feedback value. | |
| r P C ★ | [PID reference] PID setpoint value via graphic display terminal. | |
| r P O | [PID Output] PID output value with limitation. | Hz |
| Π 0 n - | [1.2 MONITORING] (continued) | |
| P E t - | [MONIT. POWER TIME] | |
| A P H | [Consumption] Energy consumption in Wh, kWh or MWh (accumulated consumption). | Wh, kWh, MWh |
| r t H | [Run time] Run elapsed time display (resetable) in seconds, minutes or hours (length of time the motor has been switched on). | s, min, h |
| P t H | [Power on time] Power elapsed time display in seconds, minutes or hours (length of time the drive has been switched on). | s, min, h |
| r P r (↻) | [Operating t. reset] Reset of run elapsed time. | |
| n 0 | [No] (n 0) : Reset operation not in progress | |
| A P H | [Reset kWh] (A P H) : Clear [Reset kWh] (A P H) | |
| r t H | [rst. runtime] (r t H) : Clear [rst. runtime] (r t H) | |
| P t H | [rst. P On t.] (P t H) : Clear [rst. P On t.] (P t H) | |
| Π 0 n - | [1.2 MONITORING] (continued) | |
| C n F 5 | [Config. active] View of the active configuration. | |
| n 0 | [In progress] (n 0) : Transitory state (configuration changing) | |
| C n F 0 | [Config. n°0] (C n F 0) : Configuration 0 active | |
| C n F 1 | [Config. n°1] (C n F 1) : Configuration 1 active | |
| C n F 2 | [Config. n°2] (C n F 2) : Configuration 2 active | |
| C F P 5 ★ | [Utilised param. set] Configuration parameter status (can be accessed if parameter switching has been enabled, see page 214). | |
| n 0 | [None] (n 0) : Not assigned | |
| C F P 1 | [Set N°1] (C F P 1) : Parameter set 1 active | |
| C F P 2 | [Set N°2] (C F P 2) : Parameter set 2 active | |
| C F P 3 | [Set N°3] (C F P 3) : Parameter set 3 active | |

| Code | Name / Description | Unit |
|--------------|--|------|
| ALGr | [Alarm groups] Current impacted alarm group numbers. Group of alarms could be user defined in [INPUTS / OUTPUTS CFG] (I - D -) page 112 . | |
| --- | [--] (- - -): No alarm group impacted | |
| 1-- | [1--] (1 - -): Alarm group 1 | |
| -2- | [-2-] (- 2 -): Alarm group 2 | |
| 12- | [12-] (1 2 -): Alarm group 1 and 2 | |
| --3 | [--3] (- - 3): Alarm group 3 | |
| 1-3 | [1-3] (1 - 3): Alarm group 1 and 3 | |
| -23 | [-23] (- 2 3): Alarm group 2 and 3 | |
| 123 | [123] (1 2 3): Alarm group 1, 2 and 3 | |
| ALr - | [ALARMS] List of current alarms. If an alarm is present, a ✓ appears on the graphic display terminal. | |
| nDRL | [No alarm] (n D R L) | |
| PTCL | [PTCL alarm] (P T C L) | |
| ETF | [External fault] (E T F) | |
| USR | [UnderV. al.] (U S R) | |
| CLR | [I attained] (C L R) | |
| FLR | [Freq. Th. attain.] (F L R) | |
| F2R | [Freq. Th. 2 attain.] (F 2 R) | |
| SRR | [Freq.ref.att] (S R R) | |
| TSR | [Th.mot. att.] (T S R) | |
| TS2 | [Th.mot2 att.] (T S 2) | |
| TS3 | [Th.mot3 att.] (T S 3) | |
| UPR | [Underv. prev.] (U P R) | |
| FLR | [HSP attain.] (F L R) | |
| THR | [Al. °C drv] (T H R) | |
| AG1 | [Alarm group 1] (A G 1) | |
| AG2 | [Alarm group 2] (A G 2) | |
| AG3 | [Alarm group 3] (A G 3) | |
| PEE | [PID error al] (P E E) | |
| PFR | [PID fdbk al.] (P F R) | |
| AP3 | [AI3 Al. 4-20mA] (A P 3) | |
| SSR | [Lim T/I att.] (S S R) | |
| TRd | [Th.driv.att.] (T R d) | |
| IJA | [IGBT alarm] (I J A) | |
| BDR | [Brake R. al.] (B D R) | |
| ULR | [Underload. Proc. Al.] (U L R) | |
| OLR | [Overload. Proc. Al.] (O L R) | |
| rSdR | [Rope slack alarm] (r S d R) | |
| TEHR | [High torque alarm] (T E H R) | |
| TELR | [Low torque alarm] (T E L R) | |
| dLdR | [Dynamic load alarm] (d L d R) | |
| FQLR | [Freq. meter Alarm] (F Q L R) | |

Parameters described in this page can be accessed by:

DRI- > MON- > SST-

| Code | Name / Description | Unit |
|--------------|---|------|
| 55E - | [OTHER STATE] List of secondary states. This menu is visible only on graphic display terminal. | |
| <i>FL</i> | [In motor fluxing] (FL) | |
| <i>PtCL</i> | [PTC Alarm] (PtCL) | |
| <i>FSt</i> | [Fast stop in prog.] (FSt) | |
| <i>CtA</i> | [Current Th. attained] (CtA) | |
| <i>FtA</i> | [Freq. Th. attained] (FtA) | |
| <i>F2A</i> | [Freq. Th. 2 attained] (F2A) | |
| <i>SrA</i> | [Frequency ref. att.] (SrA) | |
| <i>tSA</i> | [Motor th. state att.] (tSA) | |
| <i>EtF</i> | [External fault alarm] (EtF) | |
| <i>AutD</i> | [Auto restart] (AutD) | |
| <i>FtL</i> | [Remote] (FtL) | |
| <i>tUn</i> | [Auto-tuning] (tUn) | |
| <i>USA</i> | [Undervoltage] (USA) | |
| <i>CnF1</i> | [Config. 1 act.] (CnF1) | |
| <i>CnF2</i> | [Config. 2 act.] (CnF2) | |
| <i>FLA</i> | [HSP attained] (FLA) | |
| <i>AnA</i> | [Dévirage charge] (AnA) | |
| <i>CFP1</i> | [Set 1 active] (CFP1) | |
| <i>CFP2</i> | [Set 2 active] (CFP2) | |
| <i>CFP3</i> | [Set 3 active] (CFP3) | |
| <i>brS</i> | [In braking] (brS) | |
| <i>dbL</i> | [DC bus loading] (dbL) | |
| <i>tEHA</i> | [High torque alarm] (tEHA) | |
| <i>tELA</i> | [Low torque alarm] (tELA) | |
| <i>PFrd</i> | [Forward] (PFrd) | |
| <i>PrrS</i> | [Reverse] (PrrS) | |
| <i>FqLA</i> | [Freq. metre Alarm] (FqLA) | |
| dGt - | [DIAGNOSTICS] This menu is visible only on graphic display terminal. | |
| PFH - | [FAULT HISTORY] Shows the 8 last detected faults. | |
| dP1 | [Past fault 1] Fault record 1 (1 is last). | |
| <i>nDF</i> | [No fault] (nDF): No detected fault memorized | |
| <i>ASf</i> | [Angle error] (ASf): Angle setting detected fault | |
| <i>bLf</i> | [Brake control] (bLf): Brake's motor 3-phases loss | |
| <i>brF</i> | [Brake feedback] (brF): Brake contactor detected error | |
| <i>CFf</i> | [Incorrect config.] (CFf): Invalid configuration at power on | |
| <i>CFI2</i> | [Bad conf] (CFI2): Configuration transfer detected error | |
| <i>CnF</i> | [Com. network] (CnF): NET option communication interruption | |
| <i>CDf</i> | [CAN com.] (CDf): CANopen® communication interruption | |
| <i>Crf</i> | [Capa.charg] (Crf): Load relay detected fault | |
| <i>CSf</i> | [Ch.sw. fault] (CSf): Channel switching detected error | |
| <i>dCf</i> | [Diff. I fault] (dCf): Differential current detected fault | |
| <i>dLf</i> | [Load fault] (dLf): Dynamic load detected error | |
| <i>EEF1</i> | [Control EEprom] (EEF1): Control EEprom detected error | |
| <i>EEF2</i> | [Power Eeprom] (EEF2): Power EEprom detected error | |
| <i>EPF1</i> | [External fault LI/Bit] (EPF1): External detected fault from LI or local link | |
| <i>EPF2</i> | [External fault com.] (EPF2): External interruption from communication board | |
| <i>FbE</i> | [FB fault] (FbE): Function block detected error | |
| <i>FbES</i> | [FB stop fly.] (FbES): Function block stop detected error | |
| <i>FCF1</i> | [Out. contact. stuck] (FCF1): Output contactor: closed contactor | |
| <i>FCF2</i> | [Out. contact. open.] (FCF2): Output contactor: opened contactor | |
| <i>HCF</i> | [Cards pairing] (HCF): Hardware configuration detected error | |
| <i>HdF</i> | [IGBT desaturation] (HdF): Hardware detected error | |
| <i>ILF</i> | [Option int link] (ILF): Option internal link interruption | |
| <i>InF1</i> | [Rating error] (InF1): Unknown drive rating | |
| <i>InF2</i> | [PWR Calib.] (InF2): Unknown or incompatible power board | |
| <i>InF3</i> | [Int.serial link] (InF3): Internal serial link communication interruption | |
| <i>InF4</i> | [Int.Mfg area] (InF4): Invalid industrialization zone | |
| <i>InF5</i> | [Internal-option] (InF5): Unknown or incompatible option board | |

Parameters described in this page can be accessed by:

DRI- > MON- > DGT- > PFH-

| Code | Name / Description | Unit |
|----------------|--|------|
| <i>I n F 9</i> | [Internal- I measure] (<i>I n F 9</i>): Current measurement circuit detected error | |
| <i>I n F A</i> | [Internal-mains circuit] (<i>I n F A</i>): Input phase loss circuit detected error | |
| <i>I n F b</i> | [Internal- th. sensor] (<i>I n F b</i>): Thermal sensor detected error (OC or SC) | |
| <i>I n F E</i> | [Internal-CPU] (<i>I n F E</i>): CPU detected fault (ram, flash, task ...) | |
| <i>L C F</i> | [Input contactor] (<i>L C F</i>): Line contactor detected error | |
| <i>L F F 3</i> | [AI3 4-20mA loss] (<i>L F F 3</i>): AI3 4-20 mA loss | |
| <i>O b F</i> | [Overbraking] (<i>O b F</i>): Overbraking | |
| <i>O C F</i> | [Overcurrent] (<i>O C F</i>): Overcurrent | |
| <i>O H F</i> | [Drive overheat] (<i>O H F</i>): Drive overheating | |
| <i>O L C</i> | [Proc.Overload Flt] (<i>O L C</i>): Torque overload | |
| <i>O L F</i> | [Motor overload] (<i>O L F</i>): Motor overload | |
| <i>O P F 1</i> | [1 output phase loss] (<i>O P F 1</i>): Motor 1-phase loss | |
| <i>O P F 2</i> | [3out ph loss] (<i>O P F 2</i>): Motor 3-phases loss | |
| <i>O S F</i> | [Mains overvoltage] (<i>O S F</i>): Oversupply detected fault | |
| <i>O t F L</i> | [PTC fault] (<i>O t F L</i>): Motor overheating detected error from PTCL: standard product | |
| <i>P H F</i> | [Input phase loss] (<i>P H F</i>): Main input 1-phase loss | |
| <i>P t F L</i> | [LI6=PTC probe] (<i>P t F L</i>): PTCL detected error (OC or SC) | |
| <i>S A F F</i> | [Safety fault] (<i>S A F F</i>): Safety function trip | |
| <i>S C F 1</i> | [Motor short circuit] (<i>S C F 1</i>): Motor short circuit (hard detection) | |
| <i>S C F 3</i> | [Ground short circuit] (<i>S C F 3</i>): Direct ground short-circuit trip (hard detection) | |
| <i>S C F 4</i> | [IGBT short circuit] (<i>S C F 4</i>): IGBT short-circuit (hard detection) | |
| <i>S C F 5</i> | [Motor short circuit] (<i>S C F 5</i>): Load short-circuit during Igon load sequence (hard detection) | |
| <i>S L F 1</i> | [Modbus com.] (<i>S L F 1</i>): Modbus local serial communication interruption | |
| <i>S L F 2</i> | [PC com.] (<i>S L F 2</i>): PC Software communication interruption | |
| <i>S L F 3</i> | [HMI com.] (<i>S L F 3</i>): Remote terminal communication interruption | |
| <i>S O F</i> | [Overspeed] (<i>S O F</i>): Overspeed | |
| <i>S P F</i> | [Speed fdback loss] (<i>S P F</i>): Speed feedback loss | |
| <i>S r F</i> | [Torque time-out] (<i>S r F</i>): Torque regulation time-out | |
| <i>S S F</i> | [Torque/current lim] (<i>S S F</i>): Torque current limitation detected fault | |
| <i>t J F</i> | [IGBT overheat] (<i>t J F</i>): IGBT overheating | |
| <i>t n F</i> | [Auto-tuning] (<i>t n F</i>): Tune detected fault | |
| <i>U L F</i> | [Pr.Underload Flt] (<i>U L F</i>): Torque underload | |
| <i>U S F</i> | [Undervoltage] (<i>U S F</i>): Undervoltage | |
| H S 1 | [Drive state] HMI Status of the detected fault record 1. | |
| <i>t U n</i> | [Auto-tuning] (<i>t U n</i>): Auto-tuning | |
| <i>d C b</i> | [In DC inject.] (<i>d C b</i>): Injection braking | |
| <i>r d Y</i> | [Ready] (<i>r d Y</i>): Drive ready | |
| <i>n S t</i> | [Freewheel] (<i>n S t</i>): Freewheel stop control | |
| <i>r U n</i> | [Drv running] (<i>r U n</i>): Motor in steady state or run command present and zero reference | |
| <i>A C C</i> | [In accel.] (<i>A C C</i>): Acceleration | |
| <i>d E C</i> | [In decel.] (<i>d E C</i>): Deceleration | |
| <i>C L I</i> | [Current lim.] (<i>C L I</i>): Current limit | |
| <i>F S t</i> | [Fast stop] (<i>F S t</i>): Fast stop | |
| <i>F L U</i> | [Mot. fluxing] (<i>F L U</i>): Fluxing function is activated | |
| <i>n L P</i> | [no mains V.] (<i>n L P</i>): Control is powered on but the DC bus is not loaded | |
| <i>C t L</i> | [control.stop] (<i>C t L</i>): Controlled stop | |
| <i>O b r</i> | [Dec. adapt.] (<i>O b r</i>): Adapted deceleration | |
| <i>S O C</i> | [Output cut] (<i>S O C</i>): Stand by output cut | |
| <i>U S A</i> | [UnderV. al.] (<i>U S A</i>): Undervoltage alarm | |
| <i>t C</i> | [In mfg. test] (<i>t C</i>): TC indus mode activated | |
| <i>S t</i> | [in autotest] (<i>S t</i>): Self test in progress | |
| <i>F A</i> | [autotest err] (<i>F A</i>): Self test detected error | |
| <i>Y E S</i> | [Autotest OK] (<i>Y E S</i>): Self test OK | |
| <i>E P</i> | [EEPROM test] (<i>E P</i>): Self test EEPROM detected error | |
| <i>F L t</i> | [In fault] (<i>F L t</i>): Product has detected a fault | |
| <i>S S 1</i> | [SS1 active] (<i>S S 1</i>): Safety SS1 level | |
| <i>S L S</i> | [SLS active] (<i>S L S</i>): Safety SLS level | |
| <i>S t D</i> | [STO active] (<i>S t D</i>): Safety STO level | |
| E P 1 | [ETA state word] DRIVECOM status register of detected fault record 1 (same as [ETA state word] (<i>E t A</i>) page 51). | |
| I P 1 | [ETI state word] Extended status register of detected fault record 1 (see the communication parameters file). | |

Parameters described in this page can be accessed by:

DRI- > MON- > DGT- > PFH-

| Code | Name / Description | Unit |
|----------------|---|------|
| <i>C P I</i> | [Cmd word] Command register of detected fault record 1 (same as [Cmd word] (<i>C P d</i>) page 50). | |
| <i>L C P I</i> | [Motor current] Estimated motor current of detected fault record 1 (same as [Motor current] (<i>L C r</i>) page 44). | A |
| <i>r F P I</i> | [Output frequency] Estimated motor frequency of detected fault record 1 (same as [Output frequency] (<i>r F r</i>) page 44). | Hz |
| <i>r t P I</i> | [Elapsed time] Elapsed run time of detected fault record 1 (same as [Elapsed time] (<i>r t H</i>) page 56). | h |
| <i>U L P I</i> | [Mains voltage] Main voltage of detected fault record 1 (same as [Mains voltage] (<i>U L n</i>) page 44). | V |
| <i>t H P I</i> | [Motor thermal state] Motor thermal state of detected fault record 1 (same as [Motor thermal state] (<i>t H r</i>) page 44). | % |
| <i>d C C I</i> | [Command Channel] Command channel of detected fault record 1 (same as [Command channel] (<i>C P d C</i>) page 50). | |
| <i>d r C I</i> | [Channel ref. active] Reference channel of detected fault record 1 (same as [Channel ref. active] (<i>r F C C</i>) page 50). | |
| <i>P F H -</i> | [FAULT HISTORY] (continued) Shows the 8 last detected faults. | |
| <i>d P 2</i> | [Past fault 2] Identical to [Past fault 1] (<i>d P 1</i>) page 58. | |
| <i>d P 3</i> | [Past fault 3] Identical to [Past fault 1] (<i>d P 1</i>) page 58. | |
| <i>d P 4</i> | [Past fault 4] Identical to [Past fault 1] (<i>d P 1</i>) page 58. | |
| <i>d P 5</i> | [Past fault 5] Identical to [Past fault 1] (<i>d P 1</i>) page 58. | |
| <i>d P 6</i> | [Past fault 6] Identical to [Past fault 1] (<i>d P 1</i>) page 58. | |
| <i>d P 7</i> | [Past fault 7] Identical to [Past fault 1] (<i>d P 1</i>) page 58. | |
| <i>d P 8</i> | [Past fault 8] Identical to [Past fault 1] (<i>d P 1</i>) page 58. | |

Parameters described in this page can be accessed by:

DRI- > MON- > DGT- > PFL-

| Code | Name / Description | Unit |
|----------------|---|------|
| d G E - | [DIAGNOSTICS] (continued) | |
| P F L - | [CURRENT FAULT LIST] | |
| <i>n D F</i> | [No fault] (<i>n D F</i>): No detected fault memorized | |
| <i>A S F</i> | [Angle error] (<i>A S F</i>): Angle setting detected fault | |
| <i>b L F</i> | [Brake control] (<i>b L F</i>): Brake's motor 3-phases loss | |
| <i>b r F</i> | [Brake feedback] (<i>b r F</i>): Brake contactor detected error | |
| <i>C F F</i> | [Incorrect config.] (<i>C F F</i>): Invalid configuration at power on | |
| <i>C F I 2</i> | [Bad conf] (<i>C F I 2</i>): Configuration transfer detected error | |
| <i>C n F</i> | [Com. network] (<i>C n F</i>): NET option communication interruption | |
| <i>C D F</i> | [CAN com.] (<i>C D F</i>): CANopen® communication interruption | |
| <i>C r F</i> | [Capa.charg] (<i>C r F</i>): Load relay detected fault | |
| <i>C S F</i> | [Ch.sw. fault] (<i>C S F</i>): Channel switching detected error | |
| <i>d C F</i> | [Diff. I fault] (<i>d C F</i>): Differential current detected fault | |
| <i>d L F</i> | [Load fault] (<i>d L F</i>): Dynamic load detected error | |
| <i>E E F 1</i> | [Control EEprom] (<i>E E F 1</i>): Control EEprom detected error | |
| <i>E E F 2</i> | [Power Eeprom] (<i>E E F 2</i>): Power EEprom detected error | |
| <i>E P F 1</i> | [External fault LI/Bit] (<i>E P F 1</i>): External detected fault from LI or local link | |
| <i>E P F 2</i> | [External fault com.] (<i>E P F 2</i>): External interruption from communication board | |
| <i>F b E</i> | [FB fault] (<i>F b E</i>): Function block detected error | |
| <i>F b E S</i> | [FB stop fly.] (<i>F b E S</i>): Function block stop detected error | |
| <i>F C F 1</i> | [Out. contact. stuck] (<i>F C F 1</i>): Output contactor: closed contactor | |
| <i>F C F 2</i> | [Out. contact. open.] (<i>F C F 2</i>): Output contactor: opened contactor | |
| <i>H C F</i> | [Cards pairing] (<i>H C F</i>): Hardware configuration detected error | |
| <i>H d F</i> | [IGBT desaturation] (<i>H d F</i>): Hardware detected error | |
| <i>I L F</i> | [Option int link] (<i>I L F</i>): Option internal link interruption | |
| <i>I n F 1</i> | [Rating error] (<i>I n F 1</i>): Unknown drive rating | |
| <i>I n F 2</i> | [PWR Calib.] (<i>I n F 2</i>): Unknown or incompatible power board | |
| <i>I n F 3</i> | [Int.serial link] (<i>I n F 3</i>): Internal serial link communication interruption | |
| <i>I n F 4</i> | [Int.Mfg area] (<i>I n F 4</i>): Invalid industrialization zone | |
| <i>I n F 5</i> | [Internal-option] (<i>I n F 5</i>): Unknown or incompatible option board | |
| <i>I n F 9</i> | [Internal-I measure] (<i>I n F 9</i>): Current measurement circuit detected error | |
| <i>I n F A</i> | [Internal-mains circuit] (<i>I n F A</i>): Input phase loss circuit detected error | |
| <i>I n F b</i> | [Internal- th. sensor] (<i>I n F b</i>): Thermal sensor detected error (OC or SC) | |
| <i>I n F E</i> | [Internal-CPU] (<i>I n F E</i>): CPU detected fault (ram, flash, task ...) | |
| <i>L C F</i> | [Input contactor] (<i>L C F</i>): Line contactor detected error | |
| <i>L F F 3</i> | [AI3 4-20mA loss] (<i>L F F 3</i>): AI3 4-20 mA loss | |
| <i>O b F</i> | [Overbraking] (<i>O b F</i>): Overbraking | |
| <i>O C F</i> | [Overcurrent] (<i>O C F</i>): Overcurrent | |
| <i>O H F</i> | [Drive overheat] (<i>O H F</i>): Drive overheating | |
| <i>O L C</i> | [Proc.Overload Flt] (<i>O L C</i>): Torque overload | |
| <i>O L F</i> | [Motor overload] (<i>O L F</i>): Motor overload | |
| <i>O P F 1</i> | [1 output phase loss] (<i>O P F 1</i>): Motor 1-phase loss | |
| <i>O P F 2</i> | [3out ph loss] (<i>O P F 2</i>): Motor 3-phases loss | |
| <i>O S F</i> | [Mains overvoltage] (<i>O S F</i>): Oversupply detected fault | |
| <i>O t F L</i> | [PTC fault] (<i>O t F L</i>): Motor overheating detected error from PTCL: standard product | |
| <i>P H F</i> | [Input phase loss] (<i>P H F</i>): Main input 1-phase loss | |
| <i>P t F L</i> | [LI6=PTC probe] (<i>P t F L</i>): PTCL detected error (OC or SC) | |
| <i>S A F F</i> | [Safety fault] (<i>S A F F</i>): Safety function trip | |
| <i>S C F 1</i> | [Motor short circuit] (<i>S C F 1</i>): Motor short circuit (hard detection) | |
| <i>S C F 3</i> | [Ground short circuit] (<i>S C F 3</i>): Direct ground short-circuit trip (hard detection) | |
| <i>S C F 4</i> | [IGBT short circuit] (<i>S C F 4</i>): IGBT short-circuit (hard detection) | |
| <i>S C F 5</i> | [Motor short circuit] (<i>S C F 5</i>): Load short-circuit during Igon load sequence (hard detection) | |
| <i>S L F 1</i> | [Modbus com.] (<i>S L F 1</i>): Modbus local serial communication interruption | |
| <i>S L F 2</i> | [PC com.] (<i>S L F 2</i>): PC Software communication interruption | |
| <i>S L F 3</i> | [HMI com.] (<i>S L F 3</i>): Remote terminal communication interruption | |
| <i>S O F</i> | [Overspeed] (<i>S O F</i>): Overspeed | |
| <i>S P F</i> | [Speed fdback loss] (<i>S P F</i>): Speed feedback loss | |
| <i>S r F</i> | [Torque time-out] (<i>S r F</i>): Torque regulation time-out | |
| <i>S S F</i> | [Torque/current lim] (<i>S S F</i>): Torque current limitation detected fault | |
| <i>t J F</i> | [IGBT overheat] (<i>t J F</i>): IGBT overheating | |
| <i>t n F</i> | [Auto-tuning] (<i>t n F</i>): Tune detected fault | |
| <i>U L F</i> | [Pr.Underload Flt] (<i>U L F</i>): Torque underload | |
| <i>U S F</i> | [Undervoltage] (<i>U S F</i>): Undervoltage | |

Parameters described in this page can be accessed by:

DRI- > MON- > AFI-

| Code | Name / Description | Unit |
|----------------------------|---|------|
| <i>AF I -</i> | [MORE FAULT INFO] Additional detected fault information. | |
| <i>C n F</i> | [Network fault] Communication option card fault code. This parameter is read-only. The fault code remains saved in the parameter, even if the cause disappears. The parameter is reset after the drive is disconnected and then reconnected. The values of this parameter depend on the network card. Consult the manual for the corresponding card. | |
| <i>IL F 1</i> | [Internal link fault 1] Communication interruption between option card 1 and drive. This parameter is read-only. The fault code remains saved in the parameter, even if the cause disappears. The parameter is reset after the drive is disconnected and then reconnected. | |
| <i>d G t -</i> | [DIAGNOSTICS] (continued) | |
| <i>t A C</i> | [IGBT alarm counter] Transistor alarm time counter (length of time the "IGBT temperature" alarm has been active). | |
| <i>S E r -</i> | [SERVICE MESSAGE] See page 271 . | |
| <i>t A C 2</i> | [Min. freq time] Transistor alarm time counter at minimum switching frequency (length of time the "IGBT temperature" alarm has been active after the drive has automatically reduced the switching frequency to the minimum value). | |
| <i>r F L t</i> | [Reset past faults] Reset all resetable previous detected faults. | |
| <i>n D</i> <i>y E S</i> | [No] (n D): Reset not active [YES] (y E S): Reset in progress | |

| Code | Name / Description | Unit |
|---------------------|--|------|
| Π 0 n - | [1.2 MONITORING] (continued) | |
| C 0 d - | [PASSWORD] HMI Password. If you have lost your code, please contact Schneider Electric. | |
| C 5 t | [State] Status of the drive (lock/unlock). Information parameter, cannot be modified. | |
| L C | [Locked] (L C) : The drive is locked by a password | |
| U L C | [Unlocked] (U L C) : The drive is not locked by a password | |
| C 0 d | [PIN code 1] Confidential code. Enables the drive configuration to be protected using an access code. When access is locked by means of a code, only the parameters in the [1.2 MONITORING] (Π 0 n -) and [1.1 SPEED REFERENCE] (r E F -) menus can be accessed. The MODE key can be used to switch between menus. Note: Before entering a code, do not forget to make a careful note of it. | |
| 0 F F | [OFF] (0 F F) : No access locking codes. - To lock access, enter a code (2 to 9,999). The display can be incremented using the jog dial. Then press ENT. [ON] (0 n) appears on the screen to indicate that access has been locked. | |
| 0 n | [ON] (0 n) : A code is locking access (2 to 9,999). - To unlock access, enter the code (incrementing the display using the jog dial) and press ENT. The code remains on the display and access is unlocked until the next time the drive is turned off. Access will be locked again the next time the drive is turned on. - If an incorrect code is entered, the display changes to [ON] (0 n) , and access remains locked. Access is unlocked (the code remains on the screen). - To reactivate locking with the same code when access has been unlocked, return to [ON] (0 n) using the jog dial and then press ENT. [ON] (0 n) remains on the screen to indicate that access has been locked. - To lock access with a new code when access has been unlocked, enter the new code (increment the display using the jog dial) and then press ENT. [ON] (0 n) appears on the screen to indicate that access has been locked. - To clear locking when access has been unlocked, return to [OFF] (0 F F) using the jog dial and then press ENT. [OFF] (0 F F) remains on the display. Access is unlocked and will remain so until the next restart. | |
| C 0 d 2 ★ | [PIN code 2] Confidential code 2. Visible if [3.1 ACCESS LEVEL] (L A C) is set to [Expert] (E P r) . | |
| 0 F F | The value [OFF] (0 F F) indicates that no password has been set [Unlocked] (U L C) . | |
| 0 n | The value [ON] (0 n) indicates that the drive configuration is protected and an access code must be entered in order to unlock it. Once the correct code has been entered, it remains on the display and the drive is unlocked until the next time the power supply is disconnected. | |
| B B B B | PIN code 2 is an unlock code known only to Schneider Electric Product Support. | |
| U L r | [Upload rights] | |
| U L r 0 | [Permitted] (U L r 0) : Means that SoMove or the graphic display terminal can save the whole configuration (password, protections, configuration). When the configuration is edited, only the non protected parameters will be accessible. | |
| U L r 1 | [Not allowed] (U L r 1) : Means that SoMove or the graphic display terminal cannot save the configuration | |
| d L r | [Download rights] | |
| d L r 0 | [Locked drv] (d L r 0) : Locked drive: means that the configuration can be downloaded only in a locked drive which configuration has the same password. If the passwords are different, download is not permitted. | |
| d L r 1 | [Unlocked drv] (d L r 1) : Unlocked drive: means that the configuration can be downloaded only in a drive without active password | |
| d L r 2 | [Not allowed] (d L r 2) : Not allowed: the configuration cannot be downloaded | |
| d L r 3 | [Lock/unlock] (d L r 3) : Lock. + Not: download is permitted following case 0 or case 1 | |

★ These parameters only appear if the corresponding function has been selected in another menu. When the parameters can also be accessed and adjusted from within the configuration menu for the corresponding function, their description is detailed in these menus, on the pages indicated, to aid programming.

⌚ Parameter that can be modified during operation or when stopped.

Configuration Mode (ConF)



5

What's in this Chapter?

This chapter contains the following topics:

| Topic | Page |
|---------------------|--------------------|
| Introduction | 66 |
| Organization tree | 67 |
| My Menu | 68 |
| Factory Settings | 69 |
| Macro Configuration | 70 |
| Full | 73 |

Introduction

Configuration mode includes 4 parts:

1. "My Menu" menu includes up to 25 parameters available for user customization using the graphic display terminal or SoMove software.
2. Store/recall parameter set: These 2 functions are used to store and recall customer settings.
3. **[Macro configuration]** (C F G) parameter which allows to load predefined values for applications (see page [70](#)).
4. FULL: This menu provides access to all other parameters. It includes 10 sub-menus:
 - **[SIMPLY START]** (S I N -) page [73](#)
 - **[SETTINGS]** (S E T -) page [77](#)
 - **[MOTOR CONTROL]** (d r C -) page [92](#)
 - **[INPUTS / OUTPUTS CFG]** (I _ O -) page [112](#)
 - **[COMMAND]** (C L L -) page [139](#)
 - **[FUNCTION BLOCK]** (F b N -) page [143](#)
 - **[APPLICATION FUNCT.]** (F U n -) page [152](#)
 - **[FAULT MANAGEMENT]** (F L T -) page [232](#)
 - **[COMMUNICATION]** (C O M -) page [256](#)
 - **[ACCESS LEVEL]** (L A C) page [262](#)

Organization tree

Displayed parameter values are given as examples only.

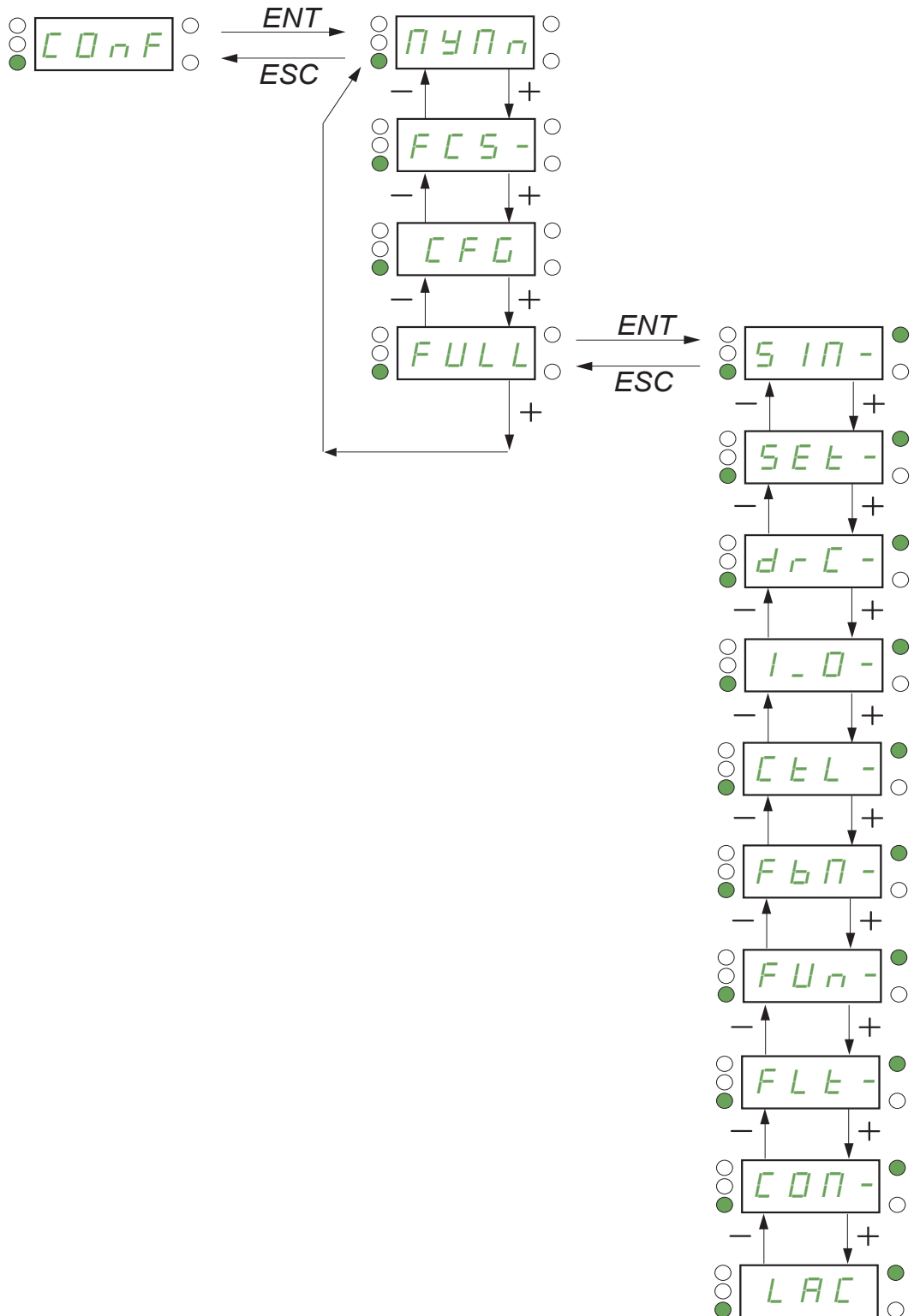

Parameters described in this page can be accessed by:

DRI- > CONF > MYMN-

My Menu

| Code | Name / Description |
|-------------------------|--|
| C O n F | [1.3 CONFIGURATION] |
| M Y M N | [MY MENU] |
| | This menu contains the parameters selected in the [3.4 DISPLAY CONFIG.] (d C F -) menu on page 269 . |

Factory Settings

| Code | Name / Description | Factory setting |
|----------------|--|-------------------------------|
| C O n F | [1.3 CONFIGURATION] | |
| F C S - | [FACTORY SETTINGS] | |
| F C S I | [Config. Source] | [Macro-Conf] (I n I) |
| ★ | <p>Choice of source configuration.</p> <p>If the configuration switching function is configured, it will not be possible to access [Config 1] (C F G I) and [Config 2] (C F G 2).</p> <p>Note: To load the drive's presets previously memorized ([Config 1] (S E r I) or [Config 2] (S E r 2)), select the source configuration [Config. Source] (F C S I) = [Config 1] (C F G I) or [Config 2] (C F G 2) followed by a factory setting [Goto FACTORY SETTINGS] (G F S) = [YES] (Y E S).</p> <p>I n I [Macro-Conf] (I n I): Factory configuration, return to selected macro configuration</p> <p>C F G I [Config 1] (C F G I): Configuration 1</p> <p>C F G 2 [Config 2] (C F G 2): Configuration 2</p> | |
| F r y - | [PARAMETER GROUP LIST] | |
| | <p>Selection of menus to be loaded.</p> <p>See the multiple selection procedure on page 33 for the integrated display terminal and page 24 for the graphic display terminal.</p> <p>Note: In factory configuration and after a return to "factory settings", [PARAMETER GROUP LIST] will be empty.</p> <p>A L L [All] (A L L): All parameters (the function blocks program will also be erased)</p> <p>d r n [Drive configuration] (d r n): The [1 DRIVE MENU] (d r I -) menu without [COMMUNICATION] (C O n -). In the [2.4 DISPLAY CONFIG.] menu, [Return std name] (G S P) page 271 returns to [No] (n D).</p> <p>n D t [Motor param] (n D t): Motor parameters, see page 279.</p> <p>The following selections can only be accessed if [Config. Source] (F C S I) is set to [Macro-Conf.] (I n I).</p> <p>C O n [Comm. menu] (C O n): The [COMMUNICATION] (C O n -) menu without either [Scan. In1 address] (n n A I) to [Scan. In8 address] (n n A B) or [Scan.Out1 address] (n C A I) to [Scan.Out8 address] (n C A B).</p> <p>d I S [Display config.] (d I S): The [3.3 MONITORING CONFIG.] (n C F -) menu</p> | |
| G F S | [Goto FACTORY SETTINGS] | |
| ★ ⌚ 2 s | <div style="border: 1px solid black; padding: 10px; text-align: center;"> <p>⚠ DANGER</p> <p>UNINTENDED EQUIPMENT OPERATION</p> <p>Check that the modification of the current configuration is compatible with the wiring diagram used.</p> <p>Failure to follow these instructions will result in death or serious injury.</p> </div> <p>It is only possible to revert to the factory settings if at least one group of parameters has previously been selected.</p> <p>n D [No] (n D): No</p> <p>Y E S [Yes] (Y E S): The parameter changes back to [No] (n D) automatically as soon as the operation is complete</p> | |
| S C S I | [Save config] | [No] (n D) |
| ★ | <p>The active configuration to be saved does not appear for selection. For example, if it is [Config 0] (S E r 0), only [Config 1] (S E r I) and [Config 2] (S E r 2) appear. The parameter changes back to [No] (n D) as soon as the operation is complete.</p> <p>n D [No] (n D): No</p> <p>S E r 0 [Config 0] (S E r 0): Press and hold down the ENT key for 2 s</p> <p>S E r I [Config 1] (S E r I): Press and hold down the ENT key for 2 s</p> <p>S E r 2 [Config 2] (S E r 2): Press and hold down the ENT key for 2 s</p> | |

★ These parameters only appear if the corresponding function has been selected in another menu. When the parameters can also be accessed and adjusted from within the configuration menu for the corresponding function, their description is detailed in these menus, on the pages indicated, to aid programming.

⌚ 2 s To change the assignment of this parameter, press the ENT key for 2 s.

Parameters described in this page can be accessed by:

DRI- > CONF

Macro Configuration

| Code | Name / Description | Factory setting |
|----------------|---|-----------------------------|
| C O n F | [1.3 CONFIGURATION] (continued) | |
| C F G | [Macro configuration] | [Start/Stop] (S t S) |
| ★ ⌚ 2 s | <div style="border: 1px solid black; padding: 5px;"> <p style="text-align: center;">⚠ DANGER</p> <p>UNINTENDED EQUIPMENT OPERATION</p> <p>Check that the selected macro configuration is compatible with the wiring diagram used. Failure to follow these instructions will result in death or serious injury.</p> </div> | |
| S t S | [Start/Stop] (S t S): Start/stop | |
| H d G | [M. handling] (H d G): Handling | |
| H S t | [Hoisting] (H S t): Hoisting | |
| G E n | [Gen. Use] (G E n): General use | |
| P I d | [PID regul.] (P I d): PID regulation | |
| n E t | [Network C.] (n E t): Communication bus | |

★ These parameters only appear if the corresponding function has been selected in another menu. When the parameters can also be accessed and adjusted from within the configuration menu for the corresponding function, their description is detailed in these menus, on the pages indicated, to aid programming.

⌚ 2 s To change the assignment of this parameter, press the ENT key for 2 s.

Example of total return to factory settings

- **[Config. Source] (F C S I)** is set to **[Macro-Conf] (I n I)**
- **[PARAMETER GROUP LIST] (F r Y -)** is set to **[All] (R L L)**
- **[Goto FACTORY SETTINGS] (G F S)** is set to **[Yes] (Y E S)**

Assignment of the inputs/outputs

| Input/output | [Start/Stop] | [M. handling] | [Gen. Use] | [Hoisting] | [PID regul.] | [Network C.] |
|-------------------------------|-----------------|-------------------|---------------------|------------------|---------------------------------|---|
| [AI1] | [Ref.1 channel] | [Ref.1 channel] | [Ref.1 channel] | [Ref.1 channel] | [Ref.1 channel] (PID reference) | [Ref.2 channel] ([Ref.1 channel] = integrated Modbus) (1) |
| [AI2] | [No] | [Summing ref. 2] | [Summing ref. 2] | [No] | [PID feedback] | [No] |
| [AI3] | [No] | [No] | [No] | [No] | [No] | [No] |
| [AO1] | [No] | [No] | [No] | [No] | [No] | [No] |
| [R1] | [No drive flt] | [No drive flt] | [No drive flt] | [No drive flt] | [No drive flt] | [No drive flt] |
| [R2] | [No] | [No] | [No] | [Brk control] | [No] | [No] |
| [LI1] (2-wire) | [Forward] | [Forward] | [Forward] | [Forward] | [Forward] | [Forward] |
| [LI2] (2-wire) | [Reverse] | [Reverse] | [Reverse] | [Reverse] | [Reverse] | [Reverse] |
| [LI3] (2-wire) | [No] | [2 preset speeds] | [Jog] | [Fault reset] | [PID integral reset] | [Ref. 2 switching] |
| [LI4] (2-wire) | [No] | [4 preset speeds] | [Fault reset] | [External fault] | [2 preset PID ref.] | [Fault reset] |
| [LI5] (2-wire) | [No] | [8 preset speeds] | [Torque limitation] | [No] | [4 preset PID ref.] | [No] |
| [LI6] (2-wire) | [No] | [Fault reset] | [No] | [No] | [No] | [No] |
| [LI1] (3-wire) | [Drive running] | [Drive running] | [Drive running] | [Drive running] | [Drive running] | [Drive running] |
| [LI2] (3-wire) | [Forward] | [Forward] | [Forward] | [Forward] | [Forward] | [Forward] |
| [LI3] (3-wire) | [Reverse] | [Reverse] | [Reverse] | [Reverse] | [Reverse] | [Reverse] |
| [LI4] (3-wire) | [No] | [2 preset speeds] | [Jog] | [Fault reset] | [PID integral reset] | [Ref. 2 switching] |
| [LI5] (3-wire) | [No] | [4 preset speeds] | [Fault reset] | [External fault] | [2 preset PID ref.] | [Fault reset] |
| [LI6] (3-wire) | [No] | [8 preset speeds] | [Torque limitation] | [No] | [4 preset PID ref.] | [No] |
| [LO1] | [No] | [No] | [No] | [No] | [No] | [No] |
| Graphic display terminal keys | | | | | | |
| F1 key | [No] | [No] | [No] | [No] | [No] | Control via graphic display terminal |
| F2, F3, F4 keys | [No] | [No] | [No] | [No] | [No] | [No] |

In 3-wire control, the assignment of inputs LI1 to LI6 shifts.

(1) To start with, integrated Modbus **[Modbus Address] (F d d)** must first be configured, page [257](#).

Note: These assignments are reinitialized every time the macro configuration changes.

Other configurations and settings

In addition to the assignment of inputs/outputs, other parameters are assigned **only in the Hoisting macro configuration**.

Hoisting:

- [Movement type] (b 5 t) is set to [Hoisting] (U E r) page 179
- [Brake contact] (b C I) is set to [No] (n D) page 179
- [Brake impulse] (b IP) is set to [Yes] (Y E S) page 179
- [Brake release I FW] (I b r) is set to [Rated mot. current] (n C r) page 179
- [Brake Release time] (b r t) is set to 0.5 s page 179
- [Brake release freq] (b I r) is set to [Auto] (A U t O) page 180
- [Brake engage freq] (b E n) is set to [Auto] (A U t O) page 180
- [Brake engage time] (b E t) is set to 0.5 s page 180
- [Engage at reversal] (b E d) is set to [No] (n D) page 180
- [Jump at reversal] (J d C) is set to [Auto] (A U t O) page 181
- [Time to restart] (t e r) is set to 0 s page 181
- [Current ramp time] (b r r) is set to 0 s page 183
- [Low speed] (L S P) is set to Rated motor slip calculated by the drive, page 75
- [Output Phase Loss] (D P L) is set to [Yes] (Y E S) page 238
No further modifications can be made to this parameter.
- [Catch on the fly] (F L r) is set to [No] (n D) page 235
No further modifications can be made to this parameter.

Return to factory settings:

Returning to factory settings with [Config. Source] (F C S I) is set to [Macro-Conf] (I n I) page 69 will return the drive to the selected macro configuration. The [Macro configuration] (C F G) parameter does not change, although [Customized macro] (C C F G) disappears.

Note: The factory settings that appear in the parameter tables correspond to

[Macro configuration] (C F G) = [Start/Stop] (S t S). This is the macro configuration set at the factory.

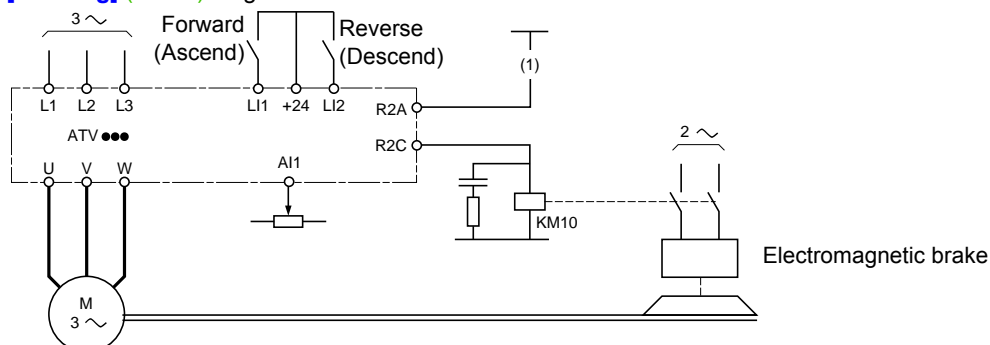

Example diagrams for use with the macro configurations

[Hoisting] (H 5 t) diagram

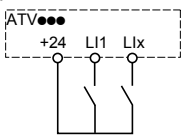
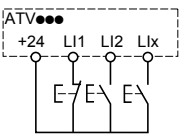

- (1) Without integrated safety function, a contact on the Preventa module must be inserted in the brake control circuit to engage it when the "Safe Torque Off" safety function is activated (see connection diagrams in the Installation manual).

Full







| Code | Name / Description | Adjustment range | Factory setting |
|--|---|---|-----------------------------|
| C O n F | [1.3 CONFIGURATION] | | |
| F U L L | [FULL] | | |
| 5 I n - | [SIMPLY START] | | |
| ε C C | [2/3 wire control] | | [2 wire] (ε C) |
|  2 s | <div style="background-color: black; color: white; text-align: center; padding: 5px;">⚠ DANGER</div> <p>UNINTENDED EQUIPMENT OPERATION</p> <p>When this parameter is changed, [Reserve assign.] (r r 5) and [2 wire type] (ε C ε) parameters, and all the assignments involving the logic inputs will revert to their default values. Check that this change is compatible with the wiring diagram used.</p> <p>Failure to follow these instructions will result in death or serious injury.</p> | | |
| | <p>See [2/3 wire control] (ε C C) page 112.</p> | | |
| ε C | [2 wire] (ε C) | <p>2-wire control (level commands): This is the input state (0 or 1) or edge (0 to 1 or 1 to 0), which controls running or stopping.</p> <p>Example of "source" wiring:</p>  <p>L1: forward Lx: reverse</p> | |
| ε C | [3 wire] (ε C) | <p>3-wire control (pulse commands): A "forward" or "reverse" pulse is sufficient to command starting, a "stop" pulse is sufficient to command stopping.</p> <p>Example of "source" wiring:</p>  <p>L1: stop L2: forward Lx: reverse</p> | |
| C F G | [Macro configuration] | | [Start/Stop] (ε ε 5) |
|   2 s | <div style="background-color: black; color: white; text-align: center; padding: 5px;">⚠ DANGER</div> <p>UNINTENDED EQUIPMENT OPERATION</p> <p>Check that the selected macro configuration is compatible with the wiring diagram used.</p> <p>Failure to follow these instructions will result in death or serious injury.</p> | | |
| | <p>See [Macro configuration] (C F G) page 70.</p> | | |
| ε ε 5 | [Start/Stop] (ε ε 5): | Start/stop | |
| H d G | [M. handling] (H d G): | Handling | |
| H 5 ε | [Hoisting] (H 5 ε): | Hoisting | |
| G E n | [Gen. Use] (G E n): | General use | |
| P I d | [PID regul.] (P I d): | PID regulation | |
| n E ε | [Network C.] (n E ε): | Communication bus | |

Parameters described in this page can be accessed by:

DRI -> CONF > FULL > SIM-

| Code | Name / Description | Adjustment range | Factory setting |
|---|---|--------------------|---|
| <p>CCFG</p> <p>★</p> <p>NO [No] (NO): No YES [Yes] (YES): Yes</p> | <p>[Customized macro]</p> <p>Read-only parameter, only visible if at least one macro configuration parameter has been modified.</p> | | |
| <p>bFr</p> <p>50 [50Hz IEC] (50): Drive 50 Hz 60 [60Hz NEMA] (60): Drive 60 Hz</p> | <p>[Standard mot. freq]</p> <p>This parameter modifies the presets of the following parameters: [Rated motor volt.] (UN5) below, [High speed] (H5P) page 75, [Freq. threshold] (Ftd) page 89, [Rated motor freq.] (Fr5) and [Max frequency] (EFr).</p> | | [50Hz IEC] (50) |
| <p>IPL</p> <p>★</p> <p>NO [Ignore] (NO): Detected fault ignored, to be used when the drive is supplied via a single-phase supply or by the DC bus YES [Freewheel] (YES): With freewheel stop</p> | <p>[Input phase loss]</p> <p>This parameter is only accessible in this menu on 3-phases drives. If one phase disappears, the drive switches to fault mode [Input phase loss] (PFH), but if 2 or 3 phases disappear, the drive continues to operate until it trips on an undervoltage detected fault (the drive trips in [Input phase loss] (PFH) if there is an input phase loss and if this leads to performance decrease). See [Input phase loss] (IPL) page 238.</p> | | Yes or No, according to drive rating |
| <p>nPr</p> <p>★</p> | <p>[Rated motor power]</p> <p>Rated motor power given on the nameplate, in kW if [Standard mot. freq] (bFr) is set to [50Hz IEC] (50), in HP if [Standard mot. freq] (bFr) is set to [60Hz NEMA] (60). See [Rated motor power] (nPr) page 94.</p> | | According to drive rating |
| <p>UN5</p> <p>★</p> | <p>[Rated motor volt.]</p> <p>Rated motor voltage given on the nameplate. ATV32...M2: 100 to 240 V – ATV32...N4: 200 to 480 V. See [Rated motor volt.] (UN5) page 94.</p> | 100 to 480 V | According to drive rating |
| <p>nCr</p> <p>★</p> | <p>[Rated mot. current]</p> <p>Rated motor current given on the nameplate. See [Rated mot. current] (nCr) page 94.</p> | 0.25 to 1.5 In (1) | According to drive rating and [Standard mot. freq] (bFr) |
| <p>Fr5</p> <p>★</p> | <p>[Rated motor freq.]</p> <p>Rated motor frequency given on the nameplate. The factory setting is 50 Hz, or preset to 60 Hz if [Standard mot. freq] (bFr) is set to 60 Hz. This parameter is not visible if [Motor control type] (CtE) page 92 is set to [Sync. mot.] (5Yn). See [Rated motor freq.] (Fr5) page 94.</p> | 10 to 599 Hz | 50 Hz |
| <p>n5P</p> <p>★</p> | <p>[Rated motor speed]</p> <p>Rated motor speed given on the nameplate. This parameter is not visible if [Motor control type] (CtE) page 92 is set to [Sync. mot.] (5Yn). See [Rated motor speed] (n5P) page 94. 0 to 9,999 rpm then 10.00 to 60.00 krpm on the integrated display terminal. If, rather than the rated speed, the nameplate indicates the synchronous speed and the slip in Hz or as a %, calculate the rated speed as follows:</p> <p>Nominal speed = Synchronous speed x $\frac{100 - \text{slip as a \%}}{100}$</p> <p>or</p> <p>Nominal speed = Synchronous speed x $\frac{50 - \text{slip in Hz}}{50}$ (50 Hz motors)</p> <p>or</p> <p>Nominal speed = Synchronous speed x $\frac{60 - \text{slip in Hz}}{60}$ (60 Hz motors)</p> | 0 to 65,535 rpm | According to drive rating |

Parameters described in this page can be accessed by: DRI- > CONF > FULL > SIM-

| Code | Name / Description | Adjustment range | Factory setting |
|---|--|---------------------|---------------------------|
| <i>EFr</i> | [Max frequency] The factory setting is 60 Hz, or preset to 72 Hz if [Standard mot. freq.] (bFr) is set to 60 Hz. The maximum value is limited by the following conditions: It must not exceed 10 times the value of [Rated motor freq.] (Fr5) . See [Max frequency] (EFr) page 92. | 10 to 599 Hz | 60 Hz |
| <i>ETun</i>  | [Auto tuning] For asynchronous motors, see page 95. For synchronous motors, see page 100. | | [No action] (nD) |
| <i>ETUS</i> | [Auto tuning state] This parameter is not saved at drive power off. It shows the Autotuning status since last power on. See [Auto tuning state] (ETUS) page 95. | | [Not done] (tAb) |
| <i>tAb</i> <i>PEnd</i> <i>PrDG</i> <i>FAIL</i> <i>dDnE</i> | [Not done] (tAb) : Autotune is not done [Pending] (PEnd) : Autotune has been requested but not yet performed [In Progress] (PrDG) : Autotune is in progress [Failed] (FAIL) : Autotune has detected a fault [Done] (dDnE) : The stator resistance measured by the auto-tuning function is used to control the motor | | |
| <i>SEUn</i> | [Tune selection] See [Tune selection] (SEUn) page 95. | | [Default] (tAb) |
| <i>tAb</i> <i>NEAS</i> <i>CUS</i> | [Default] (tAb) : The default stator resistance value is used to control the motor [Measure] (NEAS) : The stator resistance measured by the auto-tuning function is used to control the motor [Custom] (CUS) : The stator resistance set manually is used to control the motor | | |
| <i>IeH</i>  | [Mot. therm. current] Motor thermal protection current, to be set to the rated current indicated on the nameplate. See [Mot. therm. current] (IeH) page 78. | 0.2 to 1.5 In (1) | According to drive rating |
| <i>ACC</i>  | [Acceleration] Time to accelerate from 0 to the [Rated motor freq.] (Fr5) (page 74). To have repeatability in ramps, the value of this parameter must be set according to the possibility of the application. See [Acceleration] (ACC) page 77. | 0.00 to 6,000 s (2) | 3.0 s |
| <i>DEC</i>  | [Deceleration] Time to decelerate from the [Rated motor freq.] (Fr5) (page 74) to 0. To have repeatability in ramps, the value of this parameter must be set according to the possibility of the application. See [Deceleration] (DEC) page 77. | 0.00 to 6,000 s (2) | 3.0 s |
| <i>LSP</i>  | [Low speed] Motor frequency at minimum reference, can be set between 0 and [High speed] (HSP) . See [Low speed] (LSP) page 77. | 0 to 599 Hz | 0 |
| <i>HSP</i>  | [High speed] Motor frequency at maximum reference, can be set between [Low speed] (LSP) and [Max frequency] (EFr) . The factory setting changes to 60 Hz if [Standard mot. freq.] (bFr) is set to [60Hz NEMA] (bD) . See [High speed] (HSP) page 77. | 0 to 599 Hz | 50 Hz |

(1) In corresponds to the rated drive current indicated in the Installation manual and on the drive nameplate.

(2) Range 0.01 to 99.99 s or 0.1 to 999.9 s or 1 to 6,000 s according to **[Ramp increment] (Inr)** page 155.



These parameters only appear if the corresponding function has been selected in another menu. When the parameters can also be accessed and adjusted from within the configuration menu for the corresponding function, their description is detailed in these menus, on the pages indicated, to aid programming.

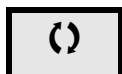

Parameter that can be modified during operation or when stopped.



To change the assignment of this parameter, press the ENT key for 2 s.

Settings

With integrated display terminal

⚠ DANGER

UNINTENDED EQUIPMENT OPERATION
 Check that changes made to the settings during operation do not present any danger.
 We recommend stopping the drive before making any changes.
Failure to follow these instructions will result in death or serious injury.



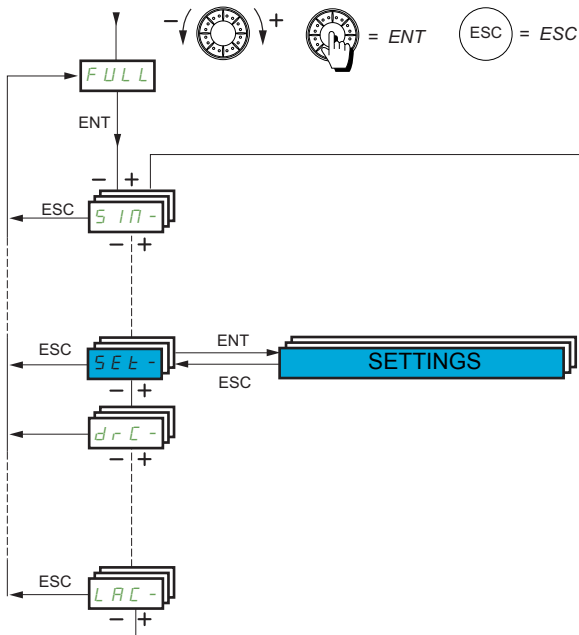







From **COnF** menu



The adjustment parameters can be modified with the drive running or stopped.

Parameters described in this page can be accessed by:

DRI > CONF > FULL > SET-

| Code | Name / Description | Adjustment range | Factory setting |
|---|--|---------------------|-----------------|
| FULL | [FULL] (continued) | | |
| SEt - | [SETTINGS] | | |
| Inr ( D. D I D. I I | [Ramp increment] This parameter is valid for [Acceleration] (ACC) , [Deceleration] (DEC) , [Acceleration 2] (AC2) and [Deceleration 2] (DE2) . See [Ramp increment] (Inr) page 155. [0,01] : Ramp up to 99.99 seconds [0,1] : Ramp up to 999.9 seconds [1] : Ramp up to 6,000 seconds | | 0.1 |
| ACC ( | [Acceleration] Time to accelerate from 0 to the [Rated motor freq.] (Fr5) page 74. To have repeatability in ramps, the value of this parameter must be set according to the possibility of the application. See [Acceleration] (ACC) page 155. | 0.00 to 6,000 s (1) | 3.0 s |
| DEC ( | [Deceleration] Time to decelerate from the [Rated motor freq.] (Fr5) page 74 to 0. To have repeatability in ramps, the value of this parameter must be set according to the possibility of the application. See [Deceleration] (DEC) page 155. | 0.00 to 6,000 s (1) | 3.0 s |
| AC2 ★ ( | [Acceleration 2] Time to accelerate from 0 to the [Rated motor freq.] (Fr5) page 74. To have repeatability in ramps, the value of this parameter must be set according to the possibility of the application. See [Acceleration 2] (AC2) page 156. | 0.00 to 6,000 s (1) | 5 s |
| DE2 ★ ( | [Deceleration 2] Time to decelerate from the [Rated motor freq.] (Fr5) page 74 to 0. To have repeatability in ramps, the value of this parameter must be set according to the possibility of the application. See [Deceleration 2] (DE2) page 156. | 0.00 to 6,000 s (1) | 5 s |
| EA1 ★ ( | [Begin Acc round] Rounding of start of acceleration ramp as a % of the [Acceleration] (ACC) or [Acceleration 2] (AC2) ramp time. Visible if [Ramp type] (rPE) is set to [Customized] (CUS) . See [Begin Acc round] (EA1) page 155. | 0 to 100% | 10% |
| EA2 ★ ( | [End Acc round] Rounding of end of acceleration ramp as a % of the [Acceleration] (ACC) or [Acceleration 2] (AC2) ramp time. Can be set between 0 and 100% - [Begin Acc round] (EA1) . Visible if [Ramp type] (rPE) is set to [Customized] (CUS) . See [End Acc round] (EA2) page 156. | 0 to 100% | 10% |
| EA3 ★ ( | [Begin Dec round] Rounding of start of deceleration ramp as a % of the [Deceleration] (DEC) or [Deceleration 2] (DE2) ramp time. Visible if [Ramp type] (rPE) is set to [Customized] (CUS) . See [Begin Dec round] (EA3) page 156. | 0 to 100% | 10% |
| EA4 ★ ( | [End Dec round] Rounding of end of deceleration ramp as a % of the [Deceleration] (DEC) or [Deceleration 2] (DE2) ramp time. Can be set between 0 and 100% - [Begin Dec round] (EA3) . Visible if [Ramp type] (rPE) is set to [Customized] (CUS) . See [End Dec round] (EA4) page 156. | 0 to 100% | 10% |
| LSP ( | [Low speed] Motor frequency at minimum reference, can be set between 0 and [High speed] (HSP) page 75. See [Low speed] (LSP) page 75. | 0 to 599 Hz | 0 Hz |
| HSP ( | [High speed] Motor frequency at maximum reference, can be set between [Low speed] (LSP) and [Max frequency] (EFR) . The factory setting changes to 60 Hz if [Standard mot. freq] (BFR) is set to [60Hz NEMA] (BD) . See [High speed] (HSP) page 75. | 0 to 599 Hz | 50 Hz |

Parameters described in this page can be accessed by:

DRI- > CONF > FULL > SET-

| Code | Name / Description | Adjustment range | Factory setting |
|-------------------------|---|-------------------|---------------------------|
| HSP2 ★ () | [High speed 2] Visible if [2 High speed] (SH2) is not set to [No] (n0). See [High speed 2] (HSP2) page 229. | 0 to 599 Hz | 50 Hz |
| HSP3 ★ () | [High speed 3] Visible if [4 High speed] (SH4) is not set to [No] (n0). See [High speed 3] (HSP3) page 229. | 0 to 599 Hz | 50 Hz |
| HSP4 ★ () | [High speed 4] Visible if [4 High speed] (SH4) is not set to [No] (n0). See [High speed 4] (HSP4) page 229. | 0 to 599 Hz | 50 Hz |
| IETH () | [Mot. therm. current] Motor thermal protection current, to be set to the rated current indicated on the nameplate. See [Mot. therm. current] (IETH) page 75. | 0.2 to 1.5 In (2) | According to drive rating |
| UFr () | [IR compensation] IR compensation. See [IR compensation] (UFr) page 105. | 0 to 200% | 100% |
| SLP ★ () | [Slip compensation] Slip compensation. See [Slip compensation] (SLP) page 105. | 0 to 300% | 100% |
| SFC ★ () | [K speed loop filter] Speed filter coefficient. See [K speed loop filter] (SFC) page 105. | 0 to 100 | 65 |
| SIE ★ () | [Speed time integral] Speed loop integral time constant. See [Speed time integral] (SIE) page 105. | 1 to 65,535 ms | 63 ms |
| SPG ★ () | [Speed prop. gain] Speed loop proportional gain. See [Speed prop. gain] (SPG) page 105. | 0 to 1,000% | 40% |
| SPGU ★ () | [UF inertia comp.] Inertia factor. See [UF inertia comp.] (SPGU) page 105. | 0 to 1,000% | 40% |

(1) Range 0.01 to 99.99 s or 0.1 to 999.9 s or 1 to 6,000 s according to **[Ramp increment]** (Inr) page 155.

(2) In corresponds to the rated drive current indicated in the Installation manual or on the drive nameplate.



These parameters only appear if the corresponding function has been selected in another menu. When the parameters can also be accessed and adjusted from within the configuration menu for the corresponding function, their description is detailed in these menus, on the pages indicated, to aid programming.

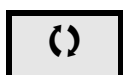

Parameter that can be modified during operation or when stopped.

Parameter settings for **[K speed loop filter] (5FL)**, **[Speed prop. gain] (5PG)** and **[Speed time integral] (5LE)**

⚠ WARNING

LOSS OF CONTROL

Bad parameter settings of the speed loop with High Inertia application may cause a Ramp non consistent with application.

Failure to follow these instructions will result in death, serious injury, or equipment damage.

The following parameters can be accessed if **[Motor control type] (CLE)** page 92 is set to **[SVC V] (UUC)**, **[Sync. mot.] (5Yn)** or **[Energy Sav.] (nLd)**.

General Case: Setting for [K speed loop filter] (5FL) = 0

The regulator is an "IP" type with filtering of the speed reference, for applications requiring flexibility and stability (hoisting or high inertia, for example).

- **[Speed prop. gain] (5PG)** affects excessive speed.
- **[Speed time integral] (5LE)** affects the passband and response time.

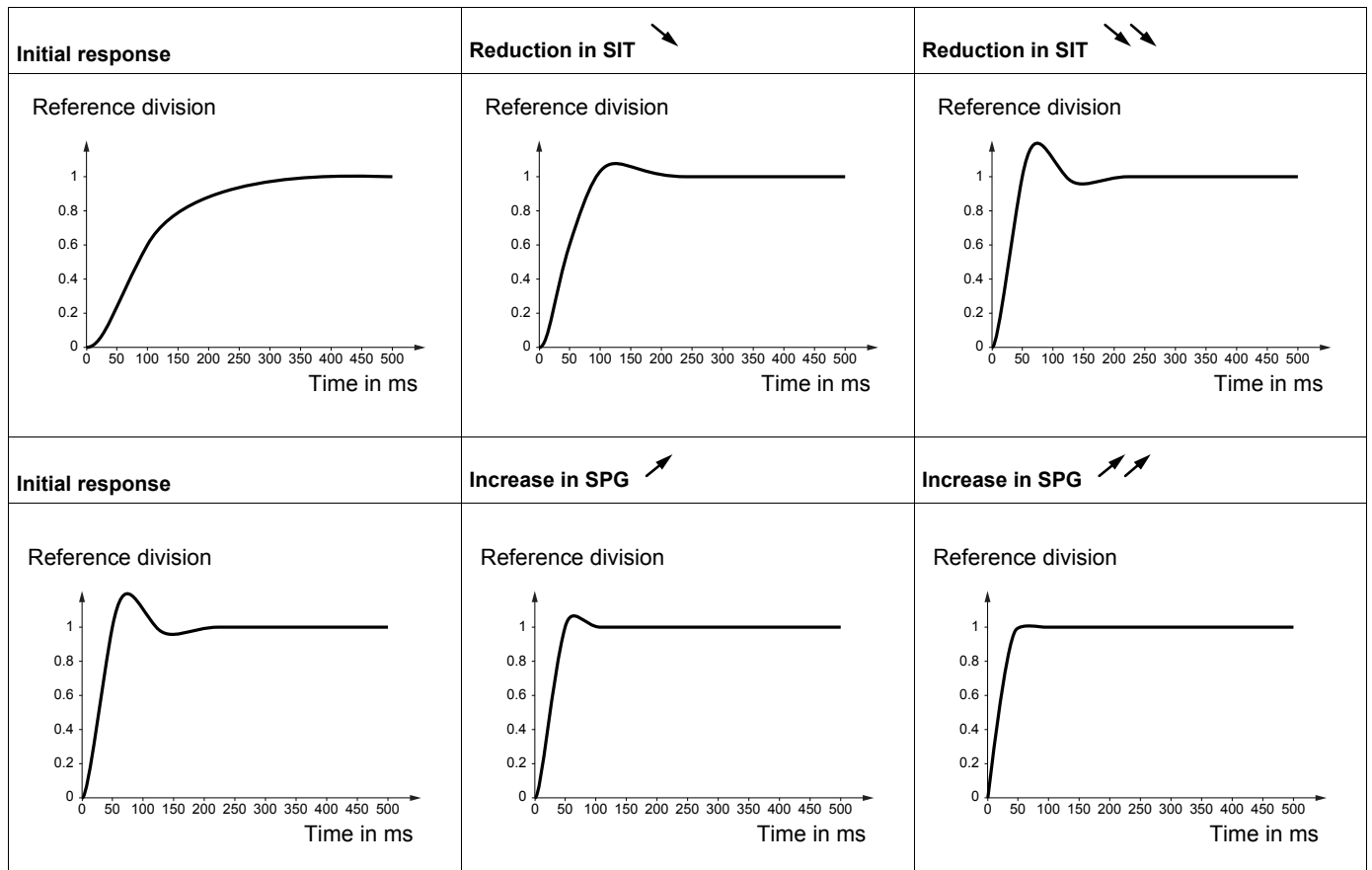

Special case: Parameter [K speed loop filter] (5FC) is not 0

This parameter must be reserved for specific applications that require a short response time (trajectory positioning or servo control).

- When set to 100 as described above, the regulator is a "PI" type, without filtering of the speed reference.
- Settings between 0 and 100 will obtain an intermediate function between the settings below and those on the previous page.

Example: Setting for [K speed loop filter] (5FC) = 100

- [Speed prop. gain] (5PG) affects the passband and response time.
- [Speed time integral] (5IE) affects excessive speed.

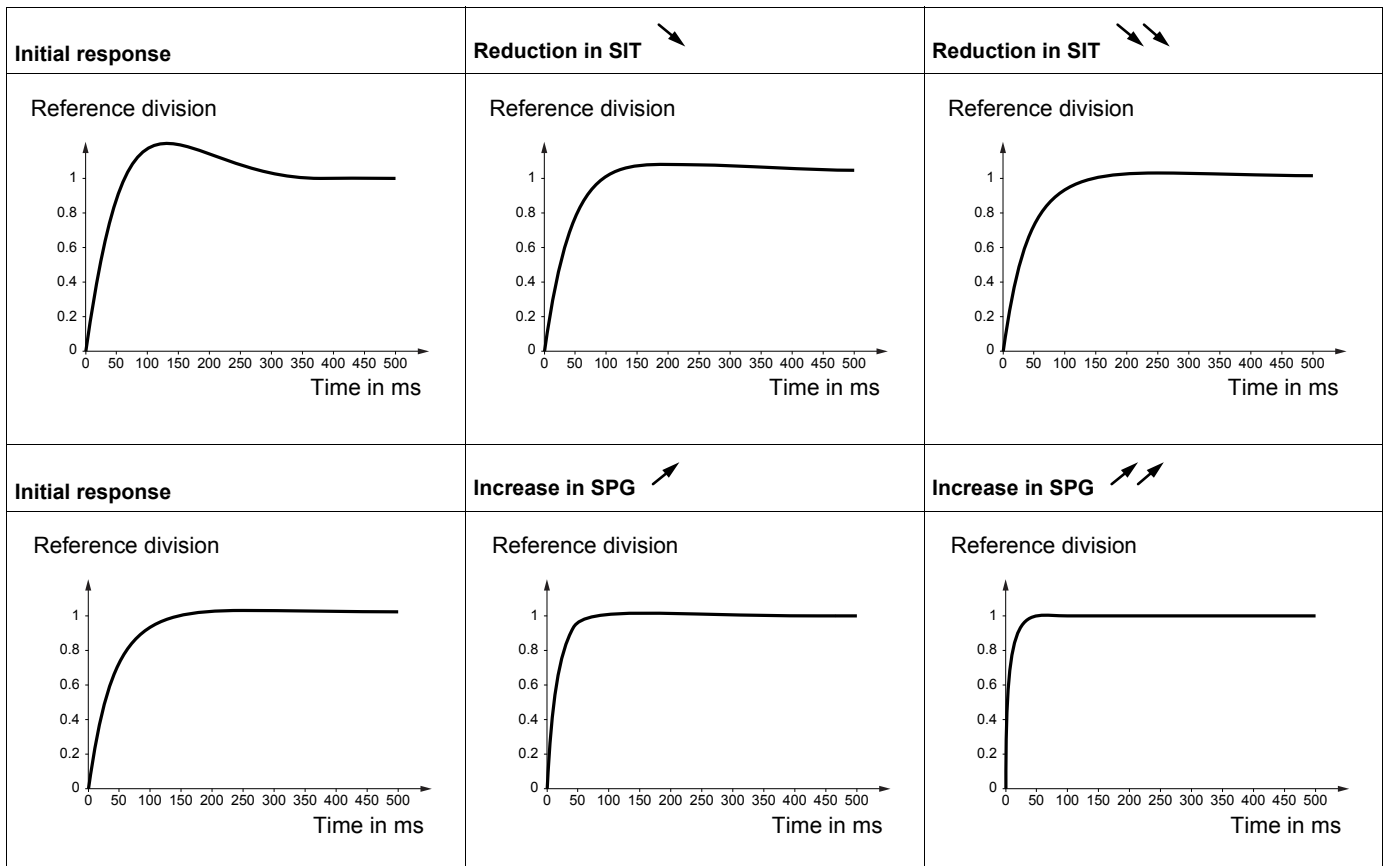

Parameters described in this page can be accessed by: DRI- > CONF > FULL > SET-

| Code | Name / Description | Adjustment range | Factory setting |
|----------------------------|---|-----------------------|-----------------|
| <i>d C F</i> ★ () | [Ramp divider] Deceleration ramp time reduction. See [Ramp divider] (<i>d C F</i>) page 158 . | 0 to 10 | 4 |
| <i>I d C</i> ★ () | [DC inject. level 1] Level of DC injection braking current activated via logic input or selected as stop mode. See [DC inject. level 1] (<i>I d C</i>) page 159 . | 0.1 to 1.41 In (1) | 0.64 In (1) |
| <i>t d I</i> ★ () | [DC injection time 1] Maximum current injection time [DC inject. level 1] (<i>I d C</i>). After this time, the injection current becomes [DC inject. level 2] (<i>I d C 2</i>). See [DC injection time 1] (<i>t d I</i>) page 159 . | 0.1 to 30 s | 0.5 s |
| <i>I d C 2</i> ★ () | [DC inject. level 2] Injection current activated by logic input or selected as stop mode, once period of time [DC injection time 1] (<i>t d I</i>) has elapsed. See [DC inject. level 2] (<i>I d C 2</i>) page 160 . | 0.1 In to 1.41 In (1) | 0.5 In (1) |
| <i>t d C</i> ★ () | [DC injection time 2] Maximum injection time [DC inject. level 2] (<i>I d C 2</i>) for injection selected as stop mode only. See [DC injection time 2] (<i>t d C</i>) page 160 . | 0.1 to 30 s | 0.5 s |
| <i>S d C I</i> ★ () | [Auto DC inj. level 1] <div style="border: 1px solid black; padding: 5px; text-align: center;">CAUTION</div> RISK OF DAMAGE TO THE MOTOR Check that the motor will withstand this current without overheating. Failure to follow these instructions can result in equipment damage. | 0 to 1.2 In (1) | 0.7 In (1) |
| <i>t d C I</i> ★ () | [Auto DC inj. time 1] <div style="border: 1px solid black; padding: 5px; text-align: center;">CAUTION</div> RISK OF DAMAGE TO THE MOTOR • Long periods of DC injection braking can cause overheating and damage the motor. • Protect the motor by avoiding long periods of DC injection braking. Failure to follow these instructions can result in equipment damage. | 0.1 to 30 s | 0.5 s |
| | Level of standstill DC injection current [Auto DC injection] (<i>A d C</i>) is not [No] (<i>n 0</i>). See page 161 . | | |
| | Standstill injection time. This parameter can be accessed if [Auto DC injection] (<i>A d C</i>) is not set to [No] (<i>n 0</i>). If [Motor control type] (<i>C t t</i>) page 92 is set to [Sync. mot.] (<i>S Y n</i>), this time corresponds to the zero speed maintenance time. See page 161 . | | |

Parameters described in this page can be accessed by:

DRI- > CONF > FULL > SET-

| Code | Name / Description | Adjustment range | Factory setting |
|----------------|---|------------------|-----------------|
| 5 d C 2 | [Auto DC inj. level 2] | 0 to 1.2 In (1) | 0.5 In (1) |
| ★ ⌚ | CAUTION RISK OF DAMAGE TO THE MOTOR Check that the motor will withstand this current without overheating. Failure to follow these instructions can result in equipment damage. | | |
| | 2nd level of standstill DC injection current. This parameter can be accessed if [Auto DC injection] (A d C) is not [No] (n 0) . See page 162 . | | |
| 6 d C 2 | [Auto DC inj. time 2] | 0 to 30 s | 0 s |
| ★ ⌚ | CAUTION RISK OF DAMAGE TO THE MOTOR <ul style="list-style-type: none"> • Long periods of DC injection braking can cause overheating and damage the motor. • Protect the motor by avoiding long periods of DC injection braking. Failure to follow these instructions can result in equipment damage. | | |
| | 2nd standstill injection time. This parameter can be accessed if [Auto DC injection] (A d C) is set to [Yes] (Y E 5) . See page 162 . | | |
| 5 F r | [Switching freq.] | 2 to 16 kHz | 4.0 kHz |
| ⌚ | CAUTION RISK OF DAMAGE TO THE DRIVE On ATV32●●●●M2 ratings, if the RFI filters are disconnected (operation on an IT system), the drive's switching frequency must not exceed 4 kHz. Failure to follow these instructions can result in equipment damage. | | |
| | Switching frequency setting. See page 106 . Adjustment range: The maximum value is limited to 4 kHz if [Motor surge limit] (S U L) parameter, page 107 is configured. Note: In the event of excessive temperature rise, the drive will automatically reduce the switching frequency and reset it once the temperature returns to normal. | | |
| C L I | [Current Limitation] | 0 to 1.5 In (1) | 1.5 In (1) |
| ★ ⌚ | CAUTION RISK OF DAMAGE TO THE MOTOR AND THE DRIVE <ul style="list-style-type: none"> • Check that the motor will withstand this current, particularly in the case of permanent magnet synchronous motors, which are susceptible to demagnetization. • Check that the profile mission complies with the derating curve given in the installation manual. Failure to follow these instructions can result in equipment damage. | | |
| | Used to limit the motor current. See page 204 . Note: If the setting is less than 0.25 In, the drive may lock in [Output Phase Loss] (O P L) fault mode if this has been enabled (see page 238). If it is less than the no-load motor current, the motor cannot run. | | |

| Code | Name / Description | Adjustment range | Factory setting |
|-----------------|--|------------------|-------------------|
| CLZ | [Limit. 2 value] | 0 to 1.5 In (1) | 1.5 In (1) |
| ★ ⌚ | <p>CAUTION</p> <p>RISK OF DAMAGE TO THE MOTOR AND THE DRIVE</p> <ul style="list-style-type: none"> • Check that the motor will withstand this current, particularly in the case of permanent magnet synchronous motors, which are susceptible to demagnetization. • Check that the profile mission complies with the derating curve given in the installation manual. <p>Failure to follow these instructions can result in equipment damage.</p> | | |
| | <p>See page 204. Note: If the setting is less than 0.25 In, the drive may lock in [Output Phase Loss] (OPL) fault mode if this has been enabled (see page 238). If it is less than the no-load motor current, the motor cannot run.</p> | | |
| FLU | [Motor fluxing] | | [No] (FnD) |
| ★ ⌚ ⌚ 2 s | <p>⚠ ⚠ DANGER</p> <p>HAZARD OF ELECTRIC SHOCK, EXPLOSION OR ARC FLASH</p> <p>When [Motor fluxing] (FLU) is set to [Continuous] (FCE), the drive automatically builds up flux. Check this action will not endanger personnel or equipment in any way.</p> <p>Failure to follow these instructions will result in death or serious injury.</p> | | |
| | <p>CAUTION</p> <p>RISK OF DAMAGE TO THE MOTOR</p> <p>Check that the motor will withstand this current without overheating.</p> <p>Failure to follow these instructions can result in equipment damage.</p> | | |
| | <p>The parameter is visible if [Motor control type] (CCE) page 92 is not set to [Sync. mot.] (SYN). In order to obtain rapid high torque on startup, magnetic flux needs to already have been established in the motor. In [Continuous] (FCE) mode, the drive automatically builds up flux when it is powered up. In [Not cont.] (FNC) mode, fluxing occurs when the motor starts up. The flux current is greater than [Rated mot. current] (nCr) when the flux is established and is then adjusted to the motor magnetizing current. See page 174.</p> <p>FNC [Not cont.] (FNC): Non-continuous mode FCE [Continuous] (FCE): Continuous mode. This option is not possible if [Auto DC injection] (AdC) page 161 is [Yes] (YES) or if [Type of stop] (SEE) page 158 is [Freewheel] (NSE). FND [No] (FND): Function inactive. This option is not possible if [Brake assignment] (bLC) page 179 is not [No] (ND).</p> | | |
| ELS | [Low speed time out] | 0 to 999.9 s | 0 s |
| ⌚ | <p>Maximum operating time at [Low speed] (LSP) (see page 75). Following operation at LSP for a defined period, a motor stop is requested automatically. The motor will restart if the reference is greater than LSP and if a run command is still present. See page 199. Note: A value of 0 indicates an unlimited period of time. Note: If [Low speed time out] (ELS) is not 0, [Type of stop] (SEE) page 158 is forced to [Ramp stop] (rPP) (only if a ramp stop can be configured).</p> | | |
| JGF | [Jog frequency] | 0 to 10 Hz | 10 Hz |
| ★ ⌚ | <p>Reference in jog operation. See page 163.</p> | | |
| JGE | [Jog delay] | 0 to 2.0 s | 0.5 s |
| ★ ⌚ | <p>Anti-repeat delay between 2 consecutive jog operations. See page 164.</p> | | |

Parameters described in this page can be accessed by:

DRI- > CONF > FULL > SET-

| Code | Name / Description | Adjustment range | Factory setting |
|---------------------------|--|------------------|-----------------|
| 5 P 2 ★ () | [Preset speed 2] Preset speed 2. See [Preset speed 2] (5 P 2) page 166 . | 0 to 599 Hz | 10 Hz |
| 5 P 3 ★ () | [Preset speed 3] Preset speed 3. See [Preset speed 3] (5 P 3) page 166 . | 0 to 599 Hz | 15 Hz |
| 5 P 4 ★ () | [Preset speed 4] Preset speed 4. See [Preset speed 4] (5 P 4) page 166 . | 0 to 599 Hz | 20 Hz |
| 5 P 5 ★ () | [Preset speed 5] Preset speed 5. See [Preset speed 5] (5 P 5) page 166 . | 0 to 599 Hz | 25 Hz |
| 5 P 6 ★ () | [Preset speed 6] Preset speed 6. See [Preset speed 6] (5 P 6) page 166 . | 0 to 599 Hz | 30 Hz |
| 5 P 7 ★ () | [Preset speed 7] Preset speed 7. See [Preset speed 7] (5 P 7) page 166 . | 0 to 599 Hz | 35 Hz |
| 5 P 8 ★ () | [Preset speed 8] Preset speed 8. See [Preset speed 8] (5 P 8) page 167 . | 0 to 599 Hz | 40 Hz |
| 5 P 9 ★ () | [Preset speed 9] Preset speed 9. See [Preset speed 9] (5 P 9) page 167 . | 0 to 599 Hz | 45 Hz |
| 5 P 10 ★ () | [Preset speed 10] Preset speed 10. See [Preset speed 10] (5 P 10) page 167 . | 0 to 599 Hz | 50 Hz |
| 5 P 11 ★ () | [Preset speed 11] Preset speed 11. See [Preset speed 11] (5 P 11) page 167 . | 0 to 599 Hz | 55 Hz |
| 5 P 12 ★ () | [Preset speed 12] Preset speed 12. See [Preset speed 12] (5 P 12) page 167 . | 0 to 599 Hz | 60 Hz |

Parameters described in this page can be accessed by:

DRI- > CONF > FULL > SET-

| Code | Name / Description | Adjustment range | Factory setting |
|--------------------------|---|------------------|-----------------|
| 5 P 13 ★ () | [Preset speed 13] Preset speed 13. See [Preset speed 13] (5 P 13) page 167 . | 0 to 599 Hz | 70 Hz |
| 5 P 14 ★ () | [Preset speed 14] Preset speed 14. See [Preset speed 14] (5 P 14) page 167 . | 0 to 599 Hz | 80 Hz |
| 5 P 15 ★ () | [Preset speed 15] Preset speed 15. See [Preset speed 15] (5 P 15) page 167 . | 0 to 599 Hz | 90 Hz |
| 5 P 16 ★ () | [Preset speed 16] Preset speed 16. See [Preset speed 16] (5 P 16) page 167 . | 0 to 599 Hz | 100 Hz |
| Π F r ★ () | [Multiplying coeff.] Multiplying coefficient, can be accessed if [Multiplier ref.] (Π R 2, Π R 3) page 154 has been assigned to the graphic display terminal. See page 40 . | 0 to 100% | 100% |
| 5 r P ★ () | [+/-Speed limitation] Limitation of +/- speed variation. See page 172 . | 0 to 50% | 10% |

Parameters described in this page can be accessed by:

DRI- > CONF > FULL > SET-

| Code | Name / Description | Adjustment range | Factory setting |
|--------------------------|---|----------------------------------|-----------------|
| r P G ★ () | [PID prop. gain] Proportional gain. See page 197 . | 0.01 to 100 | 1 |
| r I G ★ () | [PID integral gain] Integral gain. See page 197 . | 0.01 to 100 | 1 |
| r d G ★ () | [PID derivative gain] Derivative gain. See page 197 . | 0.00 to 100 | 0 |
| P r P ★ () | [PID ramp] PID acceleration/deceleration ramp, defined to go from [Min PID reference] (<i>P I P 1</i>) to [Max PID reference] (<i>P I P 2</i>) and vice versa. See page 197 . | 0 to 99.9 s | 0 s |
| P O L ★ () | [Min PID output] Minimum value of regulator output in Hz. See page 197 . | -599 to 599 Hz | 0 Hz |
| P O H ★ () | [Max PID output] Maximum value of regulator output in Hz. See page 197 . | 0 to 599 Hz | 60 Hz |
| P A L ★ () | [Min fbk alarm] Minimum monitoring threshold for regulator feedback. See page 197 . | See page 197 (2) | 100 |
| P A H ★ () | [Max fbk alarm] Maximum monitoring threshold for regulator feedback. See page 198 . | See page 198 (2) | 1,000 |
| P E r ★ () | [PID error Alarm] Regulator error monitoring threshold. See page 198 . | 0 to 65,535 (2) | 100 |
| P S r ★ () | [Speed input %] Multiplying coefficient for predictive speed input. See page 198 . | 1 to 100% | 100% |
| r P 2 ★ () | [Preset ref. PID 2] Preset PID reference. See page 200 . | See page 200 (2) | 300 |

Parameters described in this page can be accessed by:

DRI- > CONF > FULL > SET-

| Code | Name / Description | Adjustment range | Factory setting |
|------------------------|--|----------------------------------|-----------------|
| <i>r P 3</i> ★ ⌚ | [Preset ref. PID 3] Preset PID reference. See page 200 . | See page 200 (2) | 600 |
| <i>r P 4</i> ★ ⌚ | [Preset ref. PID 4] Preset PID reference. See page 200 . | See page 200 (2) | 900 |

Parameters described in this page can be accessed by:

DRI -> CONF > FULL > SET-

| Code | Name / Description | Adjustment range | Factory setting |
|---------------------------------------|---|------------------------------------|----------------------|
| <i>lbr</i> ★ () | [Brake release I FW] Brake release current threshold for lifting or forward movement. See page 179 . | 0 to 1.36 In (1) | 0.0 A |
| <i>lrd</i> ★ () | [Brake release I Rev] Brake release current threshold for lowering or reverse movement. See page 179 . | 0 to 1.36 In (1) | 0.0 A |
| <i>brt</i> ★ () | [Brake Release time] Brake release time delay. See page 179 . | 0 to 5.00 s | 0 s |
| <i>blr</i> ★ () <i>AUTD</i> | [Brake release freq] See page 180 . [Auto] (AUTD): Nominal value | [Auto] (AUTD) 0 to 10 Hz | [Auto] (AUTD) |
| <i>ben</i> ★ () | [Brake engage freq] Brake engage frequency threshold. See page 180 . | [Auto] (AUTD) 0 to 10 Hz | [Auto] (AUTD) |
| <i>tbE</i> ★ () | [Brake engage delay] <div style="border: 1px solid black; padding: 5px; text-align: center;">⚠ WARNING LOSS OF CONTROL Modify the Brake engage delay for horizontal movement only otherwise the control of the load can be lost. Failure to follow these instructions can result in death, serious injury, or equipment damage.</div> Time delay before request to engage brake. See page 180 . | 0 to 5.00 s | 0 s |
| <i>bet</i> ★ () | [Brake engage time] Brake engage time (brake response time). See page 180 . | 0 to 5.00 s | 0 s |
| <i>JdC</i> ★ () <i>AUTD</i> | [Jump at reversal] See page 181 . [Auto] (AUTD): Nominal value | [Auto] (AUTD) 0 to 10 Hz | [Auto] (AUTD) |
| <i>ter</i> ★ () | [Time to restart] Time between the end of a brake engage sequence and the start of a brake release sequence. See page 181 . | 0.00 to 15.00 s | 0.00 s |

Parameters described in this page can be accessed by:

DRI- > CONF > FULL > SET-

| Code | Name / Description | Adjustment range | Factory setting |
|-------------------------|--|---|-----------------|
| ELIP ★ () | [Motoring torque lim] Torque limitation in motor mode, as a % or in 0.1% increments of the rated torque in accordance with the [Torque increment] (INLP) parameter, page 202. See page 202. | 0 to 300% | 100% |
| ELIG ★ () | [Gen. torque lim] Torque limitation in generator mode, as a % or in 0.1% increments of the rated torque in accordance with the [Torque increment] (INLP) parameter, page 202. See page 202. | 0 to 300% | 100% |
| ERH ★ () | [Traverse freq. high] Traverse high. See page 227. | 0 to 10 Hz | 4 Hz |
| ERL ★ () | [Traverse freq. low] Traverse low. See page 227. | 0 to 10 Hz | 4 Hz |
| QSH ★ () | [Quick step High] Quick step high. See page 227. | 0 to [Traverse freq. high] (ERH) | 0 Hz |
| QSL ★ () | [Quick step Low] Quick step low. See page 227. | 0 to [Traverse freq. low] (ERL) | 0 Hz |
| CTD () | [Current threshold] Current threshold for [I attained] (CTA) function assigned to a relay or a logic output (see page 123). See page 234. | 0 to 1.5 In (1) | In (1) |
| ETH () | [High torque thd.] High torque threshold for [High tq. att.] (ETHA) function assigned to a relay or a logic output (see page 123), as a % of the rated motor torque. See page 234. | -300% to +300% | 100% |
| ETL () | [Low torque thd.] Low torque threshold for [Low tq. att.] (ETLA) function assigned to a relay or a logic output (see page 123), as a % of the rated motor torque. See page 234. | -300% to +300% | 50% |
| FQL ★ | [Pulse warning thd.] Speed threshold measured by the [FREQUENCY METER] (FQF-) function, page 247, assigned to a relay or a logic output (see page 123). See page 235. | 0 Hz to 20,000 kHz | 0 Hz |
| FED () | [Freq. threshold] Motor frequency threshold for [Freq.Th.att.] (FETA) function assigned to a relay or a logic output (see page 123), or used by the [PARAM. SET SWITCHING] (PLP-) function, page 215. See page 234. | 0.0 to 599 Hz | HSP |
| F2D () | [Freq. threshold 2] Motor frequency threshold for [Freq. Th. 2 attain.] (F2TA) function assigned to a relay or a logic output (see page 123), or used by the [PARAM. SET SWITCHING] (PLP-) function, page 215. See page 234. | 0.0 to 599 Hz | HSP |
| FFL ★ () | [Freewheel stop Thd] Speed threshold below which the motor will switch to freewheel stop. This parameter supports switching from a ramp stop to a fast stop to a freewheel stop below a low speed threshold. It can be accessed if [Type of stop] (SET) is set to [Fast stop] (F5E) or [Ramp stop] (RNP) and if [Brake assignment] (BLE) or [Auto DC injection] (ADL) are configured. See page 158. | 0.2 to 599 Hz | 0.2 Hz |

Parameters described in this page can be accessed by:

DRI- > CONF > FULL > SET-

| Code | Name / Description | Adjustment range | Factory setting |
|----------------------------|--|--|-----------------|
| E E d () | [Motor therm. level] Trip threshold for motor thermal alarm (logic output or relay). See page 237 . | 0 to 118% | 100% |
| J P F () | [Skip Frequency] Skip frequency. This parameter helps to prevent prolonged operation within an adjustable range around the regulated frequency. This function can be used to help to prevent a speed, which would cause resonance, being reached. Setting the function to 0 renders it inactive. See page 168 . | 0 to 599 Hz | 0 Hz |
| J F 2 () | [Skip Frequency 2] 2nd skip frequency. This parameter helps to prevent prolonged operation within an adjustable range around the regulated frequency. This function can be used to help to prevent a speed, which would cause resonance, being reached. Setting the function to 0 renders it inactive. See page 168 . | 0 to 599 Hz | 0 Hz |
| J F 3 () | [3rd Skip Frequency] 3rd skip frequency. This parameter helps to prevent prolonged operation within an adjustable range around the regulated frequency. This function can be used to help to prevent a speed, which would cause resonance, being reached. Setting the function to 0 renders it inactive. See page 168 . | 0 to 599 Hz | 0 Hz |
| J F H ★ () | [Skip.Freq.Hysteresis] Parameter visible if at least one skip frequency [Skip Frequency] (J P F), [Skip Frequency 2] (J F 2) or [3rd Skip Frequency] (J F 3) is different from 0. Skip frequency range: between (J P F - J F H) and (J P F + J F H) for example. This adjustment is common to the 3 frequencies (J P F , J F 2 , J F 3). See page 168 . | 0.1 to 10 Hz | 1 Hz |
| L U n ★ () | [Unld.Thr.Nom.Speed] Underload threshold at rated motor frequency ([Rated motor freq.] (F r 5) page 74), as a % of the rated motor torque. Visible only if [Unld T. Del. Detect] (U L E) page 251 is not set to 0. See page 251 . | 20 to 100% of [Rated mot. current] (n C r) | 60% |
| L U L ★ () | [Unld.Thr.0.Speed] Underload threshold at zero frequency, as a % of the rated motor torque. Visible only if [Unld T. Del. Detect] (U L E) page 251 is not set to 0. See page 251 . | 0 to [Unld.Thr.Nom.Speed] (L U n) | 0% |
| r n U d ★ () | [Unld. Freq.Thr. Det.] Underload detection minimum frequency threshold. See page 251 . | 0 to 599 Hz | 0 Hz |
| S r b ★ () | [Hysteresis Freq.Att.] Maximum deviation between the frequency reference and the motor frequency, which defines steady state operation. See page 251 . | 0.3 to 599 Hz | 0.3 Hz |
| F E U ★ () | [Underload T.B.Rest.] Minimum time permitted between an underload being detected and any automatic restart. In order for an automatic restart to be possible, the value of [Max. restart time] (E R r) page 234 must exceed that of this parameter by at least one minute. See page 252 . | 0 to 6 min | 0 min |
| L O C ★ () | [Ovld Detection Thr.] Overload detection threshold, as a % of the rated motor current [Rated mot. current] (n C r). This value must be less than the limit current in order for the function to work. See page 253 . Visible only if [Ovld Time Detect.] (E D L) is not set to 0. This parameter is used to detect an "application overload". This is not a motor or drive thermal overload. | 70% to 150% of [Rated mot. current] (n C r) | 110% |
| F E D ★ () | [Overload T.B.Rest.] Minimum time permitted between an overload being detected and any automatic restart. In order for an automatic restart to be possible, the value of [Max. restart time] (E R r) page 234 must exceed that of this parameter by at least one minute. See page 253 . | 0 to 6 min | 0 min |

| Code | Name / Description | Adjustment range | Factory setting |
|--|--|------------------|------------------------------------|
| <i>L b C</i> ★ () | [Load correction] Rated correction in Hz. See [Load correction] (<i>L b C</i>) page 109. | 0 to 599 Hz | 0 Hz |
| <i>F F Π</i> () | [Fan Mode] <div style="border: 1px solid black; padding: 5px; text-align: center;">CAUTION</div> RISK OF EQUIPMENT DAMAGE If [Fan Mode] (<i>F F Π</i>) is set to [Never] (<i>S t P</i>), the fan of the drive will not be active. Life time of Electronic component will be reduced. Check that the ambient temperature will be limited to 40°C. Failure to follow these instructions can result in equipment damage. | | [Standard] (<i>S t d</i>) |
| <i>S t d</i> <i>r U n</i> <i>S t P</i> | [Standard] (<i>S t d</i>): The fan starts and stops automatically according to the drive thermal state [Always] (<i>r U n</i>): The fan is started [Never] (<i>S t P</i>): The fan is stopped | | |

(1) In corresponds to the rated drive current indicated in the Installation manual or on the drive nameplate.

(2) If a graphic display terminal is not in use, values greater than 9,999 will be displayed on the 4-digit display with a period mark after the thousand digit, example: 15.65 for 15,650.



These parameters only appear if the corresponding function has been selected in another menu. When the parameters can also be accessed and adjusted from within the configuration menu for the corresponding function, their description is detailed in these menus, on the pages indicated, to aid programming.

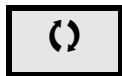

Parameter that can be modified during operation or when stopped.



To change the assignment of this parameter, press the ENT key for 2 s.

Parameters described in this page can be accessed by:

DRI- > CONF > FULL > DRC-

Motor control

The parameters in the **[MOTOR CONTROL]** (*d r C -*) menu can only be modified when the drive is stopped and no run command is present, with the following exceptions:

- **[Auto tuning]** (*t U n*) page 100, which may cause the motor to start up.
- Parameters containing the sign **()** in the code column, which can be modified with the drive running or stopped.

| Code | Name / Description | Adjustment range | Factory setting |
|----------------|--|------------------|------------------------------------|
| <i>F U L L</i> | [FULL] (continued) | | |
| <i>d r C -</i> | [MOTOR CONTROL] | | |
| <i>b F r</i> | [Standard mot. freq] This parameter modifies the presets of the following parameters: [High speed] (<i>H S P</i>) page 75, [Freq. threshold] (<i>F t d</i>) page 89, [Rated motor volt.] (<i>U n S</i>), [Rated motor freq.] (<i>F r S</i>) and [Max frequency] (<i>t F r</i>). | | [50 Hz IEC] (<i>S D</i>) |
| <i>S D</i> | [50 Hz IEC] (<i>S D</i>): IEC | | |
| <i>B D</i> | [60 Hz NEMA] (<i>B D</i>): NEMA | | |
| <i>t F r</i> | [Max frequency] The factory setting is 60 Hz, or preset to 72 Hz if [Standard mot. freq] (<i>b F r</i>) is set to 60 Hz. The maximum value is limited by the following conditions: It must not exceed 10 times the value of [Rated motor freq.] (<i>F r S</i>). | 10 to 599 Hz | 60 Hz |
| <i>C t t</i> | [Motor control type] Note: Select law before entering parameter values. | | [Standard] (<i>S t d</i>) |
| <i>U U C</i> | [SVC V] (<i>U U C</i>): Sensorless vector control with internal speed loop based on voltage feedback calculation. For applications needing high performance during starting or operation. | | |
| <i>S t d</i> | [Standard] (<i>S t d</i>): U/F 2 points (Volts/Hz) without internal speed loop. For simple applications that do not require high performance. Simple motor control law keeping a constant Voltage Frequency ratio, with a possible adjustment of the curve bottom. This law is generally used for motors connected in parallel. Some specific applications with motors in parallel and high performance levels may require [SVC V] (<i>U U C</i>). | | |
| | <p>The graph illustrates the U/F 2 points motor control law. The vertical axis represents Voltage, with a starting point U0 and a maximum point UnS. The horizontal axis represents Frequency, with a maximum point FrS. A solid blue line shows a linear relationship between voltage and frequency, starting from U0 and ending at the point (FrS, UnS). Dashed lines indicate the coordinates of this final point on the axes.</p> | | |
| | Note: U0 is the result of an internal calculation based on motor parameters and multiplied by UFr (%). U0 can be adjusted by modifying UFr value. | | |

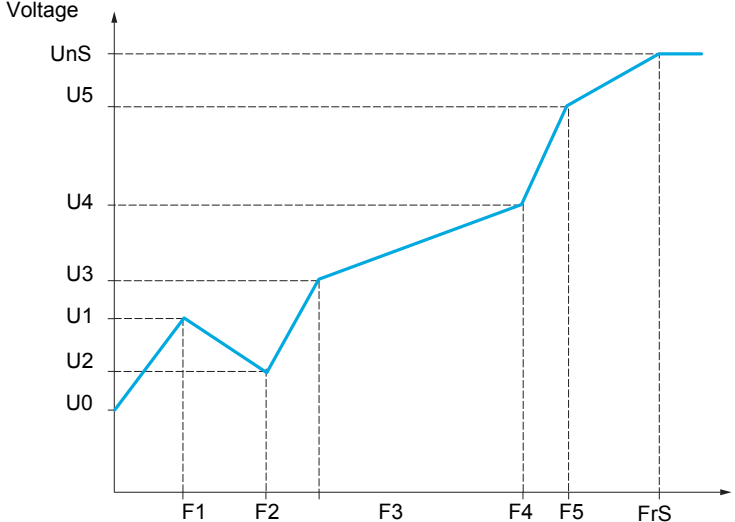

| Code | Name / Description | Adjustment range | Factory setting |
|--|--|------------------|-----------------|
| <p>UF5 [V/F 5pts.] (<i>UF5</i>): 5-segment V/F profile: As [Standard] (<i>Std</i>) profile but also supports the avoidance of resonance (saturation).</p>  <p>The profile is defined by the values of parameters UnS, FrS, U1 to U5 and F1 to F5.</p> <p>$FrS > F5 > F4 > F3 > F2 > F1$</p> <p>Note: U0 is the result of an internal calculation based on motor parameters and multiplied by UFr (%). U0 can be adjusted by modifying UFr value.</p> | <p>SYn [Sync. mot.] (<i>SYn</i>): For synchronous permanent magnet motors with sinusoidal electromotive force (EMF) only. This selection makes the asynchronous motor parameters inaccessible, and the synchronous motor parameters accessible.</p> <p>UF9 [V/F Quad.] (<i>UF9</i>): Variable torque. For pump and fan applications.</p> <p>nLd [Energy Sav.] (<i>nLd</i>): Energy saving. For applications that do not require high dynamics.</p> | | |

Parameters described in this page can be accessed by:

DRI- > CONF > FULL > DRC- > ASY-





Asynchronous motor parameters

| Code | Name / Description | Adjustment range | Factory setting |
|-------------------|--|---------------------------|---|
| ASY - | [ASYNC. MOTOR] Only visible if [Motor control type] (C E E) page 92 is not set to [Sync. mot.] (S Y n) . | | |
| n P r ★ | [Rated motor power] This parameter cannot be accessed if [Motor control type] (C E E) page 92 is set to [Sync. mot.] (S Y n) . Rated motor power given on the nameplate, in kW if [Standard mot. freq] (b F r) is set to [50Hz IEC] (S D) , in HP if [Standard mot. freq] (b F r) is set to [60Hz NEMA] (E D) . | According to drive rating | According to drive rating |
| C D S ★ | [Motor 1 Cosinus Phi] Nominal motor cos phi. This parameter can be accessed if [Motor param choice] (n P C) is set to [Mot Cos] (C D S) . | 0.5 to 1 | According to drive rating |
| U n S ★ | [Rated motor volt.] This parameter cannot be accessed if [Motor control type] (C E E) page 92 is set to [Sync. mot.] (S Y n) . Rated motor voltage given on the nameplate. | 100 to 480 V | According to drive rating and [Standard mot. freq] (b F r) |
| n C r ★ | [Rated mot. current] This parameter cannot be accessed if [Motor control type] (C E E) page 92 is set to [Sync. mot.] (S Y n) . Rated motor current given on the nameplate. | 0.25 to 1.5 In (1) | According to drive rating and [Standard mot. freq] (b F r) |
| F r S ★ | [Rated motor freq.] This parameter cannot be accessed if [Motor control type] (C E E) page 92 is set to [Sync. mot.] (S Y n) . Rated motor frequency given on the nameplate. The factory setting is 50 Hz, or preset to 60 Hz if [Standard mot. freq] (b F r) is set to 60 Hz. | 10 to 800 Hz | 50 Hz |
| n S P ★ | [Rated motor speed] This parameter cannot be accessed if [Motor control type] (C E E) page 92 is set to [Sync. mot.] (S Y n) . 0 to 9,999 rpm then 10.00 to 65.53 krpm on the integrated display terminal. If, rather than the rated speed, the nameplate indicates the synchronous speed and the slip in Hz or as a %, calculate the rated speed as follows: Nominal speed = Synchronous speed x $\frac{100 - \text{slip as a \%}}{100}$ or Nominal speed = Synchronous speed x $\frac{50 - \text{slip in Hz}}{50}$ (50 Hz motors) or Nominal speed = Synchronous speed x $\frac{60 - \text{slip in Hz}}{60}$ (60 Hz motors). | 0 to 65,535 rpm | According to drive rating |

| Code | Name / Description | Adjustment range | Factory setting |
|---|---|------------------|---------------------------|
| <p>U n</p> <p></p> <p> 2 s</p> | <p>[Auto tuning]</p> <div style="background-color: black; color: white; text-align: center; padding: 5px;"> <p>⚠ ⚠ DANGER</p> </div> <div style="border: 1px solid black; padding: 5px;"> <p>HAZARD OF ELECTRIC SHOCK OR ARC FLASH</p> <ul style="list-style-type: none"> • During auto-tuning, the motor operates at rated current. • Do not service the motor during auto-tuning. <p>Failure to follow these instructions will result in death or serious injury.</p> </div> <div style="border: 1px solid black; padding: 5px; margin-top: 10px;"> <p style="text-align: center;">⚠ WARNING</p> <p>LOSS OF CONTROL</p> <ul style="list-style-type: none"> • It is essential that the following parameters [Rated motor volt.] (U n 5), [Rated motor freq.] (F r 5), [Rated mot. current] (n C r), [Rated motor speed] (n S P), and [Rated motor power] (n P r) or [Motor 1 Cosinus Phi] (C D 5) are correctly configured before starting auto-tuning. • When one or more of these parameters have been changed after auto-tuning has been performed, [Auto tuning] (U n) will return [No action] (n D) and the procedure will have to be repeated. <p>Failure to follow these instructions can result in death, serious injury, or equipment damage.</p> </div> <p style="margin-top: 10px;">- Auto-tuning is only performed if no stop command has been activated. If a "freewheel stop" or "fast stop" function has been assigned to a logic input, this input must be set to 1 (active at 0).</p> <p>- Auto-tuning takes priority over any run or prefluxing commands, which will be taken into account after the auto-tuning sequence.</p> <p>- If auto-tuning detects a fault, the drive displays [No action] (n D) and, depending on the configuration of [Autotune fault mgt] (E n L) page 249, may switch to [Auto-tuning] (E n F) fault mode.</p> <p>- Auto-tuning may last for 1 to 2 seconds. Do not interrupt the process. Wait for the display to change to [No action] (n D).</p> <p>Note: Motor thermal state has a big influence on tune result. Make the tune with the motor stopped and cold. To redo a tune of the motor, wait that it is completely stopped and cold. Set first [Auto tuning] (U n) to [Erase tune] (C L r), then redo the motor tuning. The use of the motor tuning without doing a [Erase tune] (C L r) first is used to get the thermal state estimation of the motor. In any case, the motor has to be stopped before performing a tune operation. Cable length has an influence on the Tune result. If the cabling is modified, it is necessary to redo the tune operation.</p> <p>n D [No action] (n D): Auto-tuning not in progress</p> <p>Y E S [Do tune] (Y E S): Auto-tuning is performed immediatly if possible, then the parameter automatically changes to [No action] (n D). If the drive state does not allow the tune operation immediatly, the parameter changes to [No] (n D) and the operation must be done again.</p> <p>C L r [Erase tune] (C L r): The motor parameters measured by the auto-tuning function are reseted. The default motor parameters values are used to control the motor. [Auto tuning status] (E U 5) is set to [Not done] (E A b).</p> | | [No] (n D) |
| <p>U 5</p> <p>E A b</p> <p>P E n d</p> <p>P r O G</p> <p>F A I L</p> <p>d O n E</p> | <p>[Auto tuning state]</p> <p>(for information only, cannot be modified)</p> <p>This parameter is not saved at drive power off. It shows the Autotuning status since last power on.</p> <p>[Not done] (E A b): Autotune is not done</p> <p>[Pending] (P E n d): Autotune has been requested but not yet performed</p> <p>[In Progress] (P r O G): Autotune is in progress</p> <p>[Failed] (F A I L): Autotune has detected a fault</p> <p>[Done] (d O n E): The motor parameters measured by the auto-tuning function are used to control the motor</p> | | [Not done] (E A b) |
| <p>S U n</p> <p>E A b</p> <p>N E A S</p> <p>C U S</p> | <p>[Tune selection]</p> <p>(for information only, cannot be modified)</p> <p>[Default] (E A b): The default values are used to control the motor</p> <p>[Measure] (N E A S): The values measured by the auto-tuning function are used to control the motor</p> <p>[Custom] (C U S): The values set manually are used to control the motor</p> <p>Note: Tune of the motor will increase significantly the performances.</p> | | [Default] (E A b) |

Parameters described in this page can be accessed by:

DRI- > CONF > FULL > DRC- > ASY-

| Code | Name / Description | Adjustment range | Factory setting |
|---|---|------------------|--------------------------|
| £ U n U | [Auto tuning usage] This parameter shows the way used to modify the motor parameters according to its estimated thermal state. | | [Therm Mot] (£ n) |
| n D £ n £ £ | [No] (n D) : No thermal state estimation [Therm Mot] (£ n) : Statoric thermal state estimation based on nominal current and current consumed by the motor [Cold tun] (£ £) : Statoric thermal state estimation based on statoric resistance measured at the first cold tune and tune done at each power up | | |
| R U £ | [Automatic autotune] | | [No] (n D) |
|   2 s | <div style="background-color: black; color: white; text-align: center; padding: 5px;">⚡ ⚠ DANGER</div> <div style="border: 1px solid black; padding: 5px;">HAZARD OF ELECTRIC SHOCK, EXPLOSION OR ARC FLASH When [Automatic autotune] (R U £) is changed from [No] (n D), Autotune will be performed every time the power will be switched on. Check this action will not endanger personnel or equipment in any way. Failure to follow these instructions will result in death or serious injury.</div> <p>The motor must be stopped when switching on the drive. [Automatic autotune] (R U £) is forced to [Yes] (Y E S) if [Auto tuning usage] (£ U n U) is set to [Cold tun] (£ £). The value of motor statoric resistance measured during the tune is used to estimate the thermal state of the motor at power up.</p> | | |
| n D Y E S | [No] (n D) : Function deactivated [Yes] (Y E S) : A tune is automatically done at each power up | | |
| F L U | [Motor fluxing] | | [No] (F n D) |
|   (1)  2 s | <div style="background-color: black; color: white; text-align: center; padding: 5px;">⚡ ⚠ DANGER</div> <div style="border: 1px solid black; padding: 5px;">HAZARD OF ELECTRIC SHOCK, EXPLOSION OR ARC FLASH When [Motor fluxing] (F L U) is set to [Continuous] (F £ £), the drive automatically builds up flux. Check this action will not endanger personnel or equipment in any way. Failure to follow these instructions will result in death or serious injury.</div> <div style="border: 1px solid black; text-align: center; padding: 5px;">CAUTION</div> <div style="border: 1px solid black; padding: 5px;">RISK OF DAMAGE TO THE MOTOR Check that the motor will withstand this current without overheating. Failure to follow these instructions can result in equipment damage.</div> <p>If [Motor control type] (£ £ £) page 92 is set to [Sync. mot.] (S Y n), the factory setting is replaced by [Not cont.] (F n £). In order to obtain rapid high torque on startup, magnetic flux needs to already have been established in the motor. In [Continuous] (F £ £) mode, the drive automatically builds up flux when it is powered up. In [Not cont.] (F n £) mode, fluxing occurs when the motor starts up. The flux current is greater than [Rated mot. current] (n £ r) (configured rated motor current) when the flux is established and is then adjusted to the motor magnetizing current.</p> | | |
| F n £ F £ £ F n D | [Not cont.] (F n £) : Non-continuous mode [Continuous] (F £ £) : Continuous mode. This option is not possible if [Auto DC injection] (A d £) page 161 is [Yes] (Y E S) or if [Type of stop] (S £ £) page 158 is [Freewheel] (n S £) . [No] (F n D) : Function inactive. This option is not possible if [Brake assignment] (b L £) page 179 is not [No] (n D) . If [Motor control type] (£ £ £) page 92 is set to [Sync. mot.] (S Y n) , the [Motor fluxing] (F L U) parameter causes the alignment of the rotor and not the fluxing. If [Brake assignment] (b L £) page 179 is not [No] (n D) , the [Motor fluxing] (F L U) parameter has no effect. | | |

Parameters described in this page can be accessed by:

DRI- > CONF > FULL > DRC- > ASY-

| Code | Name / Description | Adjustment range | Factory setting |
|-----------|-------------------------|------------------|-------------------------|
| $\Pi P C$ | [Motor param choice] | | [Mot Power] ($n P r$) |
| ★ | | | |
| $n P r$ | [Mot Power] ($n P r$) | | |
| $C O S$ | [Mot Cos] ($C O S$) | | |

(1) In corresponds to the rated drive current indicated in the Installation manual and on the drive nameplate.



These parameters only appear if the corresponding function has been selected in another menu. When the parameters can also be accessed and adjusted from within the configuration menu for the corresponding function, their description is detailed in these menus, on the pages indicated, to aid programming.



Parameter that can be modified during operation or when stopped.



To change the assignment of this parameter, press the ENT key for 2 s.

Parameters described in this page can be accessed by:

DRI- > CONF > FULL > DRC- > ASY-

Asynchronous motor parameters: Expert mode

| Code | Name / Description | Adjustment range | Factory setting |
|--------------------------|--|------------------|-----------------|
| ASY - | [ASYNC. MOTOR] | | |
| r s R ★ (1) | [Cust stator resist.] Cold state stator resistance (per winding), modifiable value. The factory setting is replaced by the result of the auto-tuning operation, if it has been performed. | 0 to 65,535 mOhm | 0 mOhm |
| L f R ★ | [Lfw] Cold state leakage inductance, modifiable value. The factory setting is replaced by the result of the auto-tuning operation, if it has been performed. | 0 to 655.35 mH | 0 mH |
| I d R ★ | [Idw] Customer adjusted magnetizing current. | 0 to 6,553.5 A | 0 A |
| t r R ★ | [Cust. rotor t const.] Customer adjusted rotor time constant. | 0 to 65,535 ms | 0 ms |

(1) On the integrated display unit: 0 to 9,999 then 10.00 to 65.53 (10,000 to 65,535).



These parameters only appear if the corresponding function has been selected in another menu. When the parameters can also be accessed and adjusted from within the configuration menu for the corresponding function, their description is detailed in these menus, on the pages indicated, to aid programming.

Synchronous motor parameters

These parameters can be accessed if **[Motor control type]** ([C E E](#)) page [92](#) is set to **[Sync. mot.]** ([S Y n](#)). In this case, the asynchronous motor parameters cannot be accessed.

Advices:

The drive must be chosen to have enough current according to the need of behavior, but not too much, to have enough accuracy in the current measurement, especially with the high frequency signal injection (see **[HF inj. activation]** ([H F I](#)) page [102](#)).

Once the drive is chosen:



- Enter the motor nameplate.
- Perform the tune.
- Adjust **[Syn. EMF constant]** ([P H 5](#)) to have optimal behavior (few current in the motor in case of no-load).

Note: Performances may be higher on high saliency motors by activating high frequency injection function (see **[HF inj. activation]** ([H F I](#)) page [102](#)).

| Code | Name / Description | Adjustment range | Factory setting |
|-------------------------------------|---|--------------------|---------------------------|
| d r C - | [MOTOR CONTROL] (continued) | | |
| S Y n - | [SYNCHRONOUS MOTOR] | | |
| n C r S ★ | [Nominal I sync.] Rated synchronous motor current given on the nameplate. | 0.25 to 1.5 In (1) | According to drive rating |
| P P n S ★ | [Pole pairs] Number of pairs of poles on the synchronous motor. | 1 to 50 | According to drive rating |
| n S P S ★ (2) | [Nom motor spdsync] Rated motor speed given on the nameplate. | 0 to 48,000 rpm | According to drive rating |
| E 9 S ★ | [Motor torque] Rated motor torque given on the nameplate. | 0.1 to 6,553.5 Nm | According to drive rating |

Parameters described in this page can be accessed by:

DRI- > CONF > FULL > DRC- > SYN-

| Code | Name / Description | Adjustment range | Factory setting |
|--|---|------------------|---------------------------|
| U n | [Auto tuning] | | [No] (n 0) |
|   2 s | <div style="background-color: black; color: white; padding: 5px; font-weight: bold; font-size: 1.2em;"> ⚠ ⚠ DANGER </div> <div style="border: 1px solid black; padding: 5px; margin-top: 5px;"> <p>HAZARD OF ELECTRIC SHOCK OR ARC FLASH</p> <ul style="list-style-type: none"> • During auto-tuning, the motor operates at rated current. • Do not service the motor during auto-tuning. <p>Failure to follow these instructions will result in death or serious injury.</p> </div> | | |
| | <div style="background-color: black; color: white; padding: 5px; font-weight: bold; font-size: 1.2em;"> ⚠ WARNING </div> <div style="border: 1px solid black; padding: 5px; margin-top: 5px;"> <p>LOSS OF CONTROL</p> <ul style="list-style-type: none"> • It is essential that the following parameters [Nominal I sync.] (n C r 5), [Nom motor spdsync] (n 5 P 5), [Pole pairs] (P P n 5), [Syn. EMF constant] (P H 5), [Autotune L d-axis] (L d 5) and [Autotune L q-axis] (L q 5) are correctly configured before starting auto-tuning. • When one or more of these parameters have been changed after auto-tuning has been performed, [Auto tuning] (U n) will return [No action] (n 0) and the procedure will have to be repeated. <p>Failure to follow these instructions can result in death, serious injury, or equipment damage.</p> </div> <p style="margin-top: 10px;">- Auto-tuning is only performed if no stop command has been activated. If a "freewheel stop" or "fast stop" function has been assigned to a logic input, this input must be set to 1 (active at 0).</p> <p>- Auto-tuning takes priority over any run or prefluxing commands, which will be taken into account after the auto-tuning sequence.</p> <p>- If auto-tuning detects a fault, the drive displays [No action] (n 0) and, depending on the configuration of [Autotune fault mgt] (E n L) page 249, may switch to [Auto-tuning] (E n F) fault mode.</p> <p>- Auto-tuning may last for 1 to 2 seconds. Do not interrupt the process. Wait for the display to change to [No action] (n 0).</p> <p>Note: Motor thermal state has a big influence on tune result. Make the tune with the motor stopped and cold. To redo a tune of the motor, wait that it is completely stopped and cold. Set first [Auto tuning] (U n) to [Erase tune] (C L r), then redo the motor tuning. The use of the motor tuning without doing a [Erase tune] (C L r) first is used to get the thermal state estimation of the motor. In any case, the motor has to be stopped before performing a tune operation. Cable length has an influence on the Tune result. If the cabling is modified, it is necessary to redo the tune operation.</p> <p>n 0 [No action] (n 0): Auto-tuning not in progress</p> <p>Y E 5 [Do tune] (Y E 5): Auto-tuning is performed immediatly if possible, then the parameter automatically changes to [No action] (n 0). If the drive state does not allow the tune operation immediatly, the parameter changes to [No] (n 0) and the operation must be done again.</p> <p>C L r [Erase tune] (C L r): The motor parameters measured by the auto-tuning function are reseted. The default motor parameters values are used to control the motor. [Auto tuning status] (E U 5) is set to [Not done] (E A b).</p> | | |
| E U 5 | [Auto tuning state] | | [Not done] (E A b) |
| | <p>(for information only, cannot be modified)</p> <p>This parameter is not saved at drive power off. It shows the Autotuning status since last power on.</p> <p>E A b [Not done] (E A b): Autotune is not done</p> <p>P E n d [Pending] (P E n d): Autotune has been requested but not yet performed</p> <p>P r O G [In Progress] (P r O G): Autotune is in progress</p> <p>F A I L [Failed] (F A I L): Autotune has detected a fault</p> <p>d O n E [Done] (d O n E): The motor parameters measured by the auto-tuning function are used to control the motor</p> | | |
| S E U n | [Tune selection] | | [Default] (E A b) |
| | <p>(for information only, cannot be modified)</p> <p>Note: Tune of the motor will increase significantly the performances.</p> <p>E A b [Default] (E A b): The default values are used to control the motor</p> <p>n E A 5 [Measure] (n E A 5): The values measured by the auto-tuning function are used to control the motor</p> <p>C U 5 [Custom] (C U 5): The values set manually are used to control the motor</p> | | |

| Code | Name / Description | Adjustment range | Factory setting |
|---|---|------------------|--------------------------------|
| <p>⚡ U n U</p> <p>n D</p> <p>⚡ n</p> <p>⚡ ⚡</p> | <p>[Auto tuning usage]</p> <p>This parameter shows the way used to modify the motor parameters according to its estimated thermal state.</p> <p>[No] (n D): No thermal state estimation [Therm Mot] (⚡ n): Statoric thermal state estimation based on nominal current and current consumed by the motor [Cold tun] (⚡ ⚡): Statoric thermal state estimation based on statoric resistance measured at the first cold tune and tune done at each power up</p> | | [Therm Mot] (⚡ n) |
| <p>A U ⚡</p> <p>⌚ 2 s</p> | <p>[Automatic autotune]</p> <div style="border: 1px solid black; padding: 5px; text-align: center;"> <p>⚠ ⚠ DANGER</p> <p>HAZARD OF ELECTRIC SHOCK, EXPLOSION OR ARC FLASH</p> <p>When [Automatic autotune] (A U ⚡) is changed from [No] (n D), Autotune will be performed every time the power will be switched on.</p> <p>Check this action will not endanger personnel or equipment in any way.</p> <p>Failure to follow these instructions will result in death or serious injury.</p> </div> <p>The motor must be stopped when switching on the drive. [Automatic autotune] (A U ⚡) is forced to [Yes] (Y E S) if [Auto tuning usage] (⚡ U n U) is set to [Cold tun] (⚡ ⚡). The value of motor statoric resistance measured during the tune is used to estimate the thermal state of the motor at power up.</p> <p>n D [No] (n D): Function deactivated Y E S [Yes] (Y E S): A tune is automatically done at each power up</p> | | [No] (n D) |
| <p>S n D ⚡</p> <p>★</p> <p>n D</p> <p>L L S</p> <p>n L S</p> <p>H L S</p> | <p>[Saliency mot. state]</p> <p>(for information only, cannot be modified) Information on synchronous motor saliency. This parameter can be accessed if [Tune selection] (S ⚡ U n) is set to [Measure] (n E A S). Note: In case of motor with low saliency, the standard control law is advised.</p> <p>n D [No] (n D): Tune not done L L S [Low salient] (L L S): Low saliency level (Recommended configuration: [Angle setting type] (A S ⚡) = [PSI align] (P S I) or [PSIO align] (P S I D) and [HF inj. activation] (H F I) = [No] (n D)). n L S [Med salient] (n L S): Medium saliency level ([Angle setting type] (A S ⚡) = [SPM align] (S P n A) is possible. [HF inj. activation] (H F I) = [Yes] (Y E S) could work). H L S [High salient] (H L S): High saliency level ([Angle setting type] (A S ⚡) = [IPM align] (I P n A) is possible. [HF inj. activation] (H F I) = [Yes] (Y E S) is possible).</p> | | |
| <p>A S ⚡</p> <p>★</p> <p>I P n A</p> <p>S P n A</p> <p>P S I</p> <p>P S I D</p> <p>n D</p> | <p>[Angle setting type]</p> <p>Mode for measuring the phase-shift angle. Visible only if [Motor control type] (⚡ ⚡ ⚡) is set to [Sync. mot.] (S Y n). [PSI align] (P S I) and [PSIO align] (P S I D) are working for all type of synchronous motors. [SPM align] (S P n A) and [IPM align] (I P n A) increase performances depending on the type of synchronous motor.</p> <p>I P n A [IPM align] (I P n A): Alignment for IPM motor. Alignment mode for Interior-buried Permanent Magnet motor (usually, this kind of motor has a high saliency level). It uses high frequency injection, which is less noisy than standard alignment mode. S P n A [SPM align] (S P n A): Alignment for SPM motor. Mode for Surface-mounted Permanent Magnet motor (usually, this kind of motor has a medium or low saliency level). It uses high frequency injection, which is less noisy than standard alignment mode. P S I [PSI align] (P S I): Pulse signal injection. Standard alignment mode by pulse signal injection. P S I D [PSIO align] (P S I D): Pulse signal injection - Optimized. Standard optimized alignment mode by pulse signal injection. The phase shift angle measurement time is reduced after the first run order or tune operation, even if the drive has been turned off. n D [No align] (n D): No alignment</p> | | [PSIO align.] (P S I D) |

Parameters described in this page can be accessed by:

DRI- > CONF > FULL > DRC- > SYN-

| Code | Name / Description | Adjustment range | Factory setting |
|-------------|---|------------------|-------------------|
| HF I | [HF inj. activation] | | [No] (n D) |
| | <p>Activation of high frequency signal injection in RUN. This function allows to estimate the motor speed in a view to have torque at low speed without speed feedback.</p> <p>Note: The more the saliency is high, the more the [HF inj. activation] (HF I) function will be efficient.</p> <p>In order to ensure the performances, it could be necessary to adjust the speed loop parameters ([K speed loop filter] (S F L), [Speed time integral] (S I E) and [Speed prop. gain] (S P G), see page 105) and the speed estimation phase locked loop (Expert parameters [HF pll bandwidth] (S P b) and [HF pll dump. factor] (S P F), see page 103).</p> <p>High frequency injection is not efficient with low saliency motors (see [Saliency mot. state] (S P D E) page 101). It is advised to have 4 kHz of pwm frequency ([Switching freq.] (S F r)).</p> <p>In case of instability with no load, it is advised to decrease [Speed prop. gain] (S P G) and [HF pll bandwidth] (S P b). Then, adjust the speed loop parameters to have the dynamic behavior and the PLL gains to have a good speed estimation at low speed.</p> <p>In case of instability with load, it could help to increase the [Angle error Comp.] (P E C) parameter (mainly for SPM motor).</p> | | |
| n D | [No] (n D): Function deactivated | | |
| Y E S | [Yes] (Y E S): High frequency injection is used for speed estimation | | |

- (1) In corresponds to the rated drive current indicated in the Installation manual and on the drive nameplate.
- (2) On the integrated display unit: 0 to 9,999 then 10.00 to 65.53 (10,000 to 65,536).



These parameters only appear if the corresponding function has been selected in another menu. When the parameters can also be accessed and adjusted from within the configuration menu for the corresponding function, their description is detailed in these menus, on the pages indicated, to aid programming.



Parameter that can be modified during operation or when stopped.



To change the assignment of this parameter, press the ENT key for 2 s.

Synchronous motor: Expert mode

| Code | Name / Description | Adjustment range | Factory setting |
|--------------------------------|---|------------------------------|----------------------|
| 547 - | [SYNCHRONOUS MOTOR] | | |
| r5R5 ★ (1) | [Cust. stator R syn] Cold state stator resistance (per winding). The factory setting is replaced by the result of the auto-tuning operation, if it has been performed. The value can be entered by the user, if he knows it. | 0 to 65,535 mOhm | 0 mOhm |
| Ld5 ★ | [Autotune L d-axis] Axis "d" stator inductance in mH (per phase). On motors with smooth poles [Autotune L d-axis] (Ld5) = [Autotune L q-axis] (Lq5) = Stator inductance L . The factory setting is replaced by the result of the auto-tuning operation, if it has been performed. | 0 to 655.35 mH | 0 mH |
| Lq5 ★ | [Autotune L q-axis] Axis "q" stator inductance in mH (per phase). On motors with smooth poles [Autotune L d-axis] (Ld5) = [Autotune L q-axis] (Lq5) = Stator inductance L . The factory setting is replaced by the result of the auto-tuning operation, if it has been performed. | 0 to 655.35 mH | 0 mH |
| PHS ★ (1) | [Syn. EMF constant] Synchronous motor EMF constant, in mV per rpm (peak voltage per phase). PHS adjustment allows to reduce the current in operation without load. | 0 to 6,553.5 mV/rpm | 0 mV/rpm |
| Fr55 ★ (1) | [Nominal freq sync.] Nominal motor frequency for synchronous motor in Hz unit. Automatically updated according to [Nom motor spdsync] (nSP5) and [Pole pairs] (PPn5) data. | 10 to 800 Hz | nSP5 * PPn5 / 60 |
| SPb ★ | [HF pll bandwidth] Bandwidth of the stator frequency PII. | 0 to 100 Hz | 25 Hz |
| SPF ★ | [HF pll dump. factor] Dumping factor of the stator frequency PII. | 0 to 200% | 100% |
| PEC ★ AUE0 | [Angle error Comp.] Error compensation of the angle position in high frequency mode. It increases performances at low speed in generator and motor mode, particularly for SPM motors. [Auto] (AUE0) : The drive takes a value equal to the rated slip of the motor, calculated using the drive parameters. | 0 to 500% | 0% |
| FrI ★ | [HF injection freq.] Frequency of the high frequency injection signal. It has an influence on the noise during angle shift measurement and speed estimation accuracy. | 250 to 1,000 Hz | 500 Hz |
| Hlr ★ | [HF current level] Ratio for the current level of the high frequency injection signal. It has an influence on the noise during angle shift measurement and speed estimation accuracy. | 0 to 200% | 50% |
| PCR ★ | [PSI align curr. max] Current level in % of [Nominal I sync.] (nCr5) for [PSI align] (P5 I) and [PSIO align] (P5 IO) angle shift measurement modes. This parameter has an impact on the inductor measurement. [PSI align curr. max] (PCR) is used for tune operation. This current must be equal or higher than the maximum current level of the application, otherwise instability may occur. If [PSI align curr. max] (PCR) is set to [Auto] (AUE0) , [PSI align curr. max] (PCR) = 150% of [Nominal I sync.] (nCr5) during the tune operation and 100% of [Nominal I sync.] (nCr5) during angle shift measurement in case of standard alignment ([PSI align] (P5 I) or [PSIO align] (P5 IO)). | [Auto] (AUE0) to 300% | [Auto] (AUE0) |
| ILr ★ | [Injection level align] Current level in % of [Nominal I sync.] (nCr5) for high frequency phase-shift angle measurement IPMA type. | 0 to 200% | 25% |

Parameters described in this page can be accessed by:

DRI- > CONF > FULL > DRC- > SYN-

| Code | Name / Description | Adjustment range | Factory setting |
|------------|---|------------------|-----------------|
| 5 / r ★ | [Boost level align.] Current level in % of [Nominal I sync.] (n L r 5) for high frequency phase-shift angle measurement SPMA type. | 0 to 200% | 100% |

(1) On the integrated display unit: 0 to 9,999 then 10.00 to 65.53 (10,000 to 65,536).



These parameters only appear if the corresponding function has been selected in another menu. When the parameters can also be accessed and adjusted from within the configuration menu for the corresponding function, their description is detailed in these menus, on the pages indicated, to aid programming.

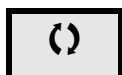

Parameter that can be modified during operation or when stopped.

| Code | Name / Description | Adjustment range | Factory setting |
|----------------------------|--|--------------------------------|-----------------|
| d r C - | [MOTOR CONTROL] (continued) | | |
| S P G ★ () | [Speed prop. gain] Speed loop proportional gain. Visible if [Motor control type] (C E E) is not set to [Standard] (S E d) , [V/F 5pts] (U F 5) or [V/F Quad.] (U F 9) . | 0 to 1,000% | 40% |
| S P G U ★ () | [UF inertia comp.] Inertia factor for following motor control laws. Visible if [Motor control type] (C E E) is set to [Standard] (S E d) , [V/F 5pts] (U F 5) or [V/F Quad.] (U F 9) . | 0 to 1,000% | 40% |
| S I E ★ () | [Speed time integral] Speed loop integral time constant. Visible if [Motor control type] (C E E) is not set to [Standard] (S E d) , [V/F 5pts] (U F 5) or [V/F Quad.] (U F 9) . | 1 to 65,535 ms | 63 ms |
| S F C ★ () | [K speed loop filter] Speed filter coefficient (0(IP) to 100(PI)). | 0 to 100 | 65 |
| F F H ★ | [Spd est. filter time] Accessible in Expert mode only. Frequency to filter the estimated speed. | 0 to 100 ms | 6.4 ms |
| C r E F ★ | [Cur. ref. filter time] Accessible in Expert mode only. Filter time of the current reference filter [of control law (if [No] (n D) : stator natural frequency)]. | 0 to 100 ms | 3.2 ms |
| U F r () | [IR compensation] Used to optimize torque at very low speed, or to adapt to special cases (for example: for motors connected in parallel, decrease [IR compensation] (U F r)). If there is insufficient torque at low speed, increase [IR compensation] (U F r) . A too high value can avoid the motor to start (locking) or change the current limiting mode. | 0 to 200% | 100% |
| S L P ★ () | [Slip compensation] This parameter cannot be accessed if [Motor control type] (C E E) is set to [Sync. mot.] (S Y n) . This parameter is written at 0% when [Motor control type] (C E E) is set to [V/F Quad.] (U F 9) . Adjusts the slip compensation around the value set by the rated motor speed. The speeds given on motor nameplates are not necessarily exact. If slip setting is lower than actual slip: The motor is not rotating at the correct speed in steady state, but at a speed lower than the reference. If slip setting is higher than actual slip: The motor is overcompensated and the speed is unstable. | 0 to 300% | 100% |
| U 1 ★ | [U1] V/F profile setting. This parameter can be accessed if [Motor control type] (C E E) is set to [V/F 5pts] (U F 5) . | 0 to 800 V according to rating | 0 V |
| F 1 ★ | [F1] V/F profile setting. This parameter can be accessed if [Motor control type] (C E E) is set to [V/F 5pts] (U F 5) . | 0 to 599 Hz | 0 Hz |
| U 2 ★ | [U2] V/F profile setting. This parameter can be accessed if [Motor control type] (C E E) is set to [V/F 5pts] (U F 5) . | 0 to 800 V according to rating | 0 V |
| F 2 ★ | [F2] V/F profile setting. This parameter can be accessed if [Motor control type] (C E E) is set to [V/F 5pts] (U F 5) . | 0 to 599 Hz | 0 Hz |

Parameters described in this page can be accessed by:

DRI- > CONF > FULL > DRC-

| Code | Name / Description | Adjustment range | Factory setting |
|-------------------------|--|--------------------------------|-----------------------------|
| U3 ★ | [U3] V/F profile setting. This parameter can be accessed if [Motor control type] (C L E) is set to [V/F 5pts] (U F 5) . | 0 to 800 V according to rating | 0 V |
| F3 ★ | [F3] V/F profile setting. This parameter can be accessed if [Motor control type] (C L E) is set to [V/F 5pts] (U F 5) . | 0 to 599 Hz | 0 Hz |
| U4 ★ | [U4] V/F profile setting. This parameter can be accessed if [Motor control type] (C L E) is set to [V/F 5pts] (U F 5) . | 0 to 800 V according to rating | 0 V |
| F4 ★ | [F4] V/F profile setting. This parameter can be accessed if [Motor control type] (C L E) is set to [V/F 5pts] (U F 5) . | 0 to 599 Hz | 0 Hz |
| U5 ★ | [U5] V/F profile setting. This parameter can be accessed if [Motor control type] (C L E) is set to [V/F 5pts] (U F 5) . | 0 to 800 V according to rating | 0 V |
| F5 ★ | [F5] V/F profile setting. This parameter can be accessed if [Motor control type] (C L E) is set to [V/F 5pts] (U F 5) . | 0 to 599 Hz | 0 Hz |
| C L I ★ () | [Current Limitation] <div style="border: 1px solid black; padding: 10px; text-align: center;">CAUTION RISK OF DAMAGE TO THE MOTOR AND THE DRIVE • Check that the motor will withstand this current, particularly in the case of permanent magnet synchronous motors, which are susceptible to demagnetization. • Check that the profile mission complies with the derating curve given in the installation manual. Failure to follow these instructions can result in equipment damage.</div> First current limitation. Note: If the setting is less than 0.25 In, the drive may lock in [Output Phase Loss] (O P L) fault mode if this has been enabled (see page 238). If it is less than the no-load motor current, the motor cannot run. | 0 to 1.5 In (1) | 1.5 In (1) |
| S F E H F 1 H F 2 | [Switch. freq type] The motor switching frequency will be modified (reduced) when the internal temperature of the drive will be too high. [SFR type 1] (H F 1): Heating optimization Allows the system to adapt the switching frequency according to the motor frequency. [SFR type 2] (H F 2): Motor noise optimization (for high switching frequency) Allows the system to keep a constant chosen switching frequency [Switching freq.] (S F r) whatever the motor frequency [Output frequency] (r F r) . In the event of overheating, the drive automatically decreases the switching frequency. It is restored to its original value when the temperature returns to normal. | | [SFR type 1] (H F 1) |
| S F r () | [Switching freq.] <div style="border: 1px solid black; padding: 10px; text-align: center;">CAUTION RISK OF DAMAGE TO THE DRIVE On ATV32●●●M2 ratings, if the RFI filters are disconnected (operation on an IT system), the drive's switching frequency must not exceed 4 kHz. Failure to follow these instructions can result in equipment damage.</div> Switching frequency setting. Adjustment range: The maximum value is limited to 4 kHz if [Motor surge limit] (S U L) parameter page 107 is configured. Note: In the event of excessive temperature rise, the drive will automatically reduce the switching frequency and reset it once the temperature returns to normal. In case of high speed motor, it is advised to increase the pwm frequency [Switching freq.] (S F r) at 8, 12 or 16 kHz. | 2 to 16 kHz | 4 kHz |

Parameters described in this page can be accessed by: DRI- > CONF > FULL > DRC-

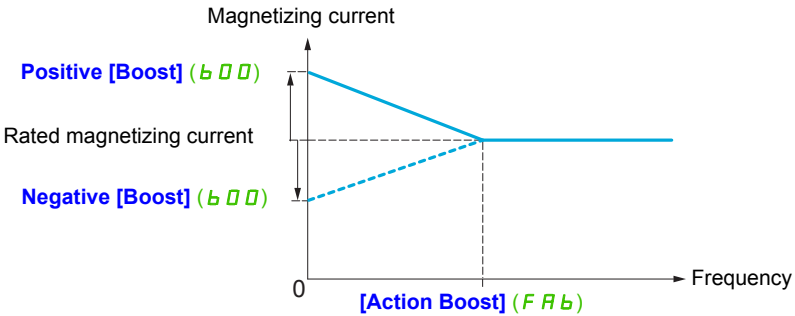
| Code | Name / Description | Adjustment range | Factory setting |
|---------------------------|--|------------------|----------------------------|
| n r d | [Noise reduction] Random frequency modulation helps to prevent any resonance, which may occur at a fixed frequency. | | [No] (n D) |
| n D Y E S | [No] (n D): Fixed frequency [Yes] (Y E S): Frequency with random modulation | | |
| b D R | [Boost activation] | | [Dynamic] (d Y n R) |
| n D d Y n R S t A t | [Inactive] (n D): No boost [Dynamic] (d Y n R): Dynamic boost [Static] (S t A t): Static boost | | |
| b D D | [Boost] This parameter can be accessed if [Boost activation] (b D R) is not set to [No] (n D). Adjustment of the motor magnetizing current at low speed, as a % of the rated magnetizing current. This parameter is used to increase or reduce the time taken to establish the torque. It allows gradual adjustment up to the frequency set by [Action Boost] (F R b). Negative values apply particularly to tapered rotor motors. | -100 to 100% | 0% |
| ★ |  | | |
| F R b | [Action Boost] This parameter can be accessed if [Boost activation] (b D R) is not set to [No] (n D). Frequency above which the magnetizing current is no longer affected by [Boost] (b D D). | 0 to 599 Hz | 0 Hz |
| ★ | | | |
| S U L | [Motor surge limit.] This function limits motor overvoltages and is useful in the following applications: - NEMA motors - Japanese motors - Spindle motors - Rewound motors This parameter can remain set to [No] (n D) for 230/400 V motors used at 230 V, or if the length of cable between the drive and the motor does not exceed: - 4 m with unshielded cables - 10 m with shielded cables Note: When [Motor surge limit.] (S U L) is set to [Yes] (Y E S), the maximum switching frequency [Switching freq.] (S F r) is modified, see page 107. | | [No] (n D) |
| n D Y E S | [No] (n D): Function inactive [Yes] (Y E S): Function active | | |
| S O P | [Volt surge limit. opt] Optimization parameter for transient overvoltages at the motor terminals. This parameter can be accessed if [Motor surge limit.] (S U L) is set to [Yes] (Y E S). Set to 6, 8 or 10 μs, according to the following table. Note: This parameter is useful for ATV32●●N4 drives. | | 10 μs |
| ★ 6 8 10 | | | |

★ These parameters only appear if the corresponding function has been selected in another menu. When the parameters can also be accessed and adjusted from within the configuration menu for the corresponding function, their description is detailed in these menus, on the pages indicated, to aid programming.

() Parameter that can be modified during operation or when stopped.

The value of the **[Volt surge limit. opt] (SDP)** parameter corresponds to the attenuation time of the cable used. It is defined to help to prevent the superimposition of voltage wave reflections resulting from long cable lengths. It limits overvoltages to twice the DC bus rated voltage.

The tables on the following page give examples of correspondence between the **[Volt surge limit. opt] (SDP)** parameter and the length of the cable between the drive and the motor. For longer cable lengths, an output of the filter or a dV/dt protection filter must be used.

For motors in parallel, the sum of all the cable lengths must be taken into consideration. Compare the length given in the table row corresponding to the power for one motor with that corresponding to the total power, and select the shorter length.

Example: Two 7.5 kW (10 HP) motors

Take the lengths on the 15 kW (20 HP) table row, which are shorter than those on the 7.5 kW (10 HP) row, and divide by the number of motors to obtain the length per motor (with unshielded "GORSE" cable and SOP = 6, the result is $40/2 = 20$ m maximum for each 7.5 kW (10 HP) motor).

In special cases (for example, different types of cable, different motor powers in parallel, different cable lengths in parallel, etc.), we recommend using an oscilloscope to check the overvoltage values obtained at the motor terminals.

To retain the overall drive performance, do not increase the SOP value unnecessarily.

Tables giving the correspondence between the SOP parameter and the cable length, for 400 V line supply

| Reference | Motor | | Cable cross-section (min) | | Maximum cable length in meters | | | | | | | | |
|-------------|-------|------|---------------------------|-----|--|---------|---------|---|---------|---------|---------------------------------------|---------|---------|
| | kW | HP | in mm ² | AWG | Unshielded "GORSE" cable Type H07 RN-F 4Gxx | | | Shielded "GORSE" cable Type GVCSTV-LS/LH | | | Shielded "BELDEN" cable Type 2950x | | |
| | | | | | SOP = 10 | SOP = 8 | SOP = 6 | SOP = 10 | SOP = 8 | SOP = 6 | SOP = 10 | SOP = 8 | SOP = 6 |
| ATV32HO37N4 | 0.37 | 0.50 | 1.5 | 14 | 100 m | 70 m | 45 m | 105 m | 85 m | 65 m | 50 m | 40 m | 30 m |
| ATV32HO55N4 | 0.55 | 0.75 | 1.5 | 14 | 100 m | 70 m | 45 m | 105 m | 85 m | 65 m | 50 m | 40 m | 30 m |
| ATV32HO75N4 | 0.75 | 1 | 1.5 | 14 | 100 m | 70 m | 45 m | 105 m | 85 m | 65 m | 50 m | 40 m | 30 m |
| ATV32HU11N4 | 1.1 | 1.5 | 1.5 | 14 | 100 m | 70 m | 45 m | 105 m | 85 m | 65 m | 50 m | 40 m | 30 m |
| ATV32HU15N4 | 1.5 | 2 | 1.5 | 14 | 100 m | 70 m | 45 m | 105 m | 85 m | 65 m | 50 m | 40 m | 30 m |
| ATV32HU22N4 | 2.2 | 3 | 1.5 | 14 | 110 m | 65 m | 45 m | 105 m | 85 m | 65 m | 50 m | 40 m | 30 m |
| ATV32HU30N4 | 3 | - | 1.5 | 14 | 110 m | 65 m | 45 m | 105 m | 85 m | 65 m | 50 m | 40 m | 30 m |
| ATV32HU40N4 | 4 | 5 | 2.5 | 12 | 110 m | 65 m | 45 m | 105 m | 85 m | 65 m | 50 m | 40 m | 30 m |
| ATV32HU55N4 | 5.5 | 7.5 | 4 | 10 | 120 m | 65 m | 45 m | 105 m | 85 m | 65 m | 50 m | 40 m | 30 m |
| ATV32HU75N4 | 7.5 | 10 | 6 | 8 | 120 m | 65 m | 45 m | 105 m | 85 m | 65 m | 50 m | 40 m | 30 m |
| ATV32HD11N4 | 11 | 15 | 10 | 8 | 115 m | 60 m | 45 m | 100 m | 75 m | 55 m | 50 m | 40 m | 30 m |
| ATV32HD15N4 | 15 | 20 | 16 | 6 | 105 m | 60 m | 40 m | 100 m | 70 m | 50 m | 50 m | 40 m | 30 m |

For 230/400 V motors used at 230 V, the **[Motor surge limit.] (SUL)** parameter can remain set to **[No] (nD)**.

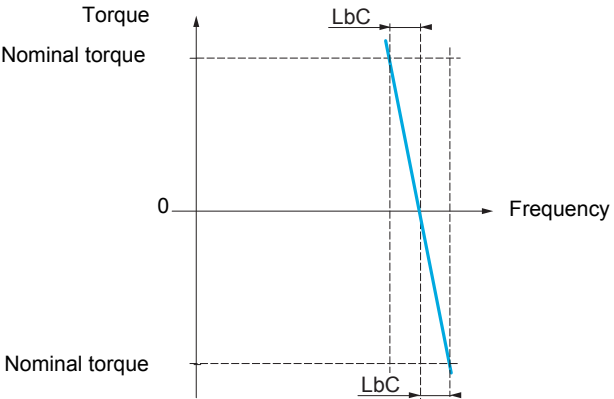
| Code | Name / Description | Adjustment range | Factory setting |
|-----------------|---|------------------|-----------------------------------|
| Ubr () | [Braking level] Braking transistor command level. | 335 to 820 V | According to drive rating voltage |
| LbR ★ | [Load sharing] When 2 motors are connected mechanically and therefore at the same speed, and each is controlled by a drive, this function can be used to improve torque distribution between the two motors. To do this, it varies the speed based on the torque. This parameter can only be accessed if [Motor control type] (LEE) page 92 is set to [SVC V] (UVL). nD [No] (nD): Function inactive YES [Yes] (YES): Function active | | [No] (nD) |
| LbC ★ () | [Load correction] Rated correction in Hz. This parameter can be accessed if [Load sharing] (LbR) is set to [Yes] (YES).  | 0 to 599 Hz | 0 Hz |



These parameters only appear if the corresponding function has been selected in another menu. When the parameters can also be accessed and adjusted from within the configuration menu for the corresponding function, their description is detailed in these menus, on the pages indicated, to aid programming.

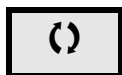

Parameter that can be modified during operation or when stopped.

Load sharing, parameters that can be accessed at expert level

Principle:

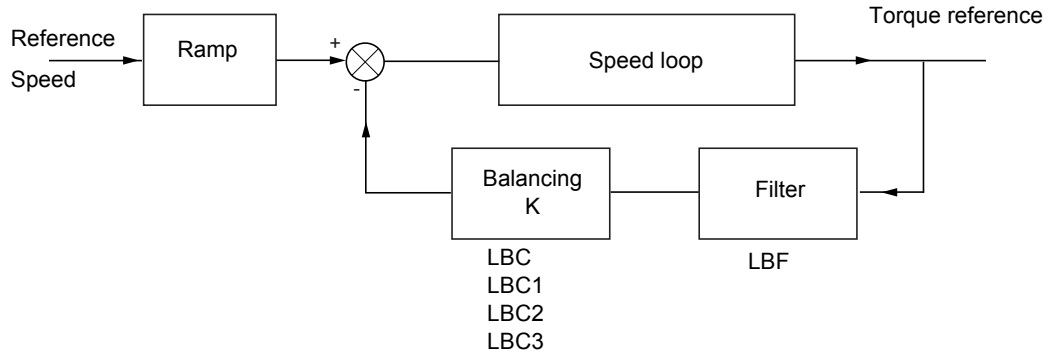

The load sharing factor K is determined by the torque and speed, with two factors K1 and K2 ($K = K1 \times K2$).

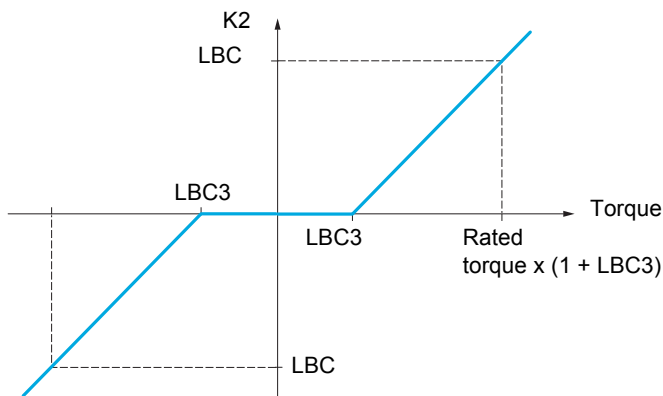
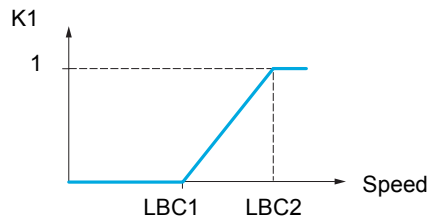

| Code | Name / Description | Adjustment range | Factory setting |
|---|--|--|-----------------|
| <p>L b C 1</p> <p>★</p> <p>()</p> | <p>[Correction min spd]</p> <p>This parameter can be accessed if [Load sharing] (L b R) is set to [Yes] (Y E S). Minimum speed for load correction in Hz. Below this threshold, no corrections are made. Used to cancel correction at very low speed if this would hamper rotation of the motor.</p> | 0 to 598.9 Hz | 0 Hz |
| <p>L b C 2</p> <p>★</p> <p>()</p> | <p>[Correction max spd]</p> <p>This parameter can be accessed if [Load sharing] (L b R) is set to [Yes] (Y E S). Speed threshold in Hz above which maximum load correction is applied.</p> | <p>[Correction min spd] (L b C 1) + 0.1 at 599 Hz</p> | 0.1 Hz |
| <p>L b C 3</p> <p>★</p> <p>()</p> | <p>[Torque offset]</p> <p>This parameter can be accessed if [Load sharing] (L b R) is set to [Yes] (Y E S). Minimum torque for load correction as a % of the rated torque. Below this threshold, no corrections are made. Used to avoid torque instabilities when the torque direction is not constant.</p> | 0 to 300% | 0% |
| <p>L b F</p> <p>★</p> <p>()</p> | <p>[Sharing filter]</p> <p>This parameter can be accessed if [Load sharing] (L b R) is set to [Yes] (Y E S). Time constant (filter) for correction in ms. Used in the event of flexible mechanical coupling in order to avoid instabilities.</p> | 0 to 20 s | 100 ms |



These parameters only appear if the corresponding function has been selected in another menu. When the parameters can also be accessed and adjusted from within the configuration menu for the corresponding function, their description is detailed in these menus, on the pages indicated, to aid programming.



Parameter that can be modified during operation or when stopped.

Parameters described in this page can be accessed by:

DRI- > CONF > FULL > I_O-

Inputs / outputs CFG

The parameters in the **[INPUTS / OUTPUTS CFG] (I _ O -)** menu can only be modified when the drive is stopped and no run command is present.

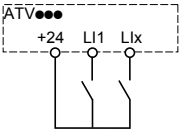
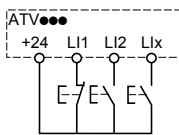
| Code | Name / Description | Adjustment range | Factory setting |
|----------------|---|------------------|-----------------------------|
| F U L L | [FULL] (continued) | | |
| I _ O - | [INPUTS / OUTPUTS CFG] | | |
| ℰ ℰ ℰ | [2/3 wire control] | | [2 wire] (ℰ ℰ) |
| ⌚ 2 s | <div style="background-color: black; color: white; padding: 5px; font-weight: bold; font-size: 1.2em;">⚠ DANGER</div> <p>UNINTENDED EQUIPMENT OPERATION When this parameter is changed, [Reserve assign.] (r r 5) and [2 wire type] (ℰ ℰ ℰ) parameters, and all the assignments involving the logic inputs will revert to their default values. Check that this change is compatible with the wiring diagram used. Failure to follow these instructions will result in death or serious injury.</p> | | |
| ℰ ℰ | [2 wire] (ℰ ℰ) 2-wire control (level commands): This is the input state (0 or 1) or edge (0 to 1 or 1 to 0) which controls running or stopping. Example of "source" wiring:  <p style="margin-left: 20px;">L11: forward L1x: reverse</p> | | |
| ℰ ℰ | [3 wire] (ℰ ℰ) 3-wire control (pulse commands): A "forward" or "reverse" pulse is sufficient to command starting, a "stop" pulse is sufficient to command stopping. Example of "source" wiring:  <p style="margin-left: 20px;">L11: stop L12: forward L1x: reverse</p> | | |
| ℰ ℰ ℰ | [2 wire type] | | [Transition] (ℰ r n) |
| ★ ⌚ 2 s | <div style="background-color: black; color: white; padding: 5px; font-weight: bold; font-size: 1.2em;">⚠ DANGER</div> <p>UNINTENDED EQUIPMENT OPERATION Check that the modification of the 2 wire type controls is compatible with the wiring diagram used. Failure to follow these instructions will result in death or serious injury.</p> | | |
| L E L | [Level] (L E L): State 0 or 1 is taken into account for run (1) or stop (0) | | |
| ℰ r n | [Transition] (ℰ r n): A change of state (transition or edge) is necessary to initiate operation, in order to avoid accidental restarts after a break in the power supply | | |
| P F D | [Fwd priority] (P F D): State 0 or 1 is taken into account for run or stop, but the "forward" input takes priority over the "reverse" input | | |

Parameters described in this page can be accessed by:

DRI- > CONF > FULL > I_O-

| Code | Name / Description | Adjustment range | Factory setting |
|----------------|---|------------------|-------------------------------|
| <i>r U n</i> | [Drive Running] Assignment of the stop command. Visible only if [2/3 wire control] (<i>E C C</i>) is set to [3 wire] (<i>3 C</i>). | | [No] (<i>n 0</i>) |
| ★ | | | |
| <i>L I I</i> | [LI1] (<i>L I I</i>): Logical input LI1 if not in [I/O profile] (<i>I 0</i>) | | |
| <i>C d 0 0</i> | [Cd00] (<i>C d 0 0</i>): In [I/O profile] (<i>I 0</i>), can be switched with possible logic inputs | | |
| <i>O L 0 1</i> | [OL01] (<i>O L 0 1</i>): Function blocks: Logical Output 01 | | |
| ... | ... | | |
| <i>O L 1 0</i> | [OL10] (<i>O L 1 0</i>): Function blocks: Logical Output 10 | | |
| <i>F r d</i> | [Forward] Assignment of the forward direction command. | | [LI1] (<i>L I I</i>) |
| <i>L I I</i> | [LI1] (<i>L I I</i>): Logical input LI1 if not in [I/O profile] (<i>I 0</i>) | | |
| <i>C d 0 0</i> | [Cd00] (<i>C d 0 0</i>): In [I/O profile] (<i>I 0</i>), can be switched with possible logic inputs | | |
| <i>O L 0 1</i> | [OL01] (<i>O L 0 1</i>): Function blocks: Logical Output 01 | | |
| ... | ... | | |
| <i>O L 1 0</i> | [OL10] (<i>O L 1 0</i>): Function blocks: Logical Output 10 | | |
| <i>r r S</i> | [Reverse assign.] Assignment of the reverse direction command. | | [LI2] (<i>L I 2</i>) |
| <i>n 0</i> | [No] (<i>n 0</i>): Not assigned | | |
| <i>L I I</i> | [LI1] (<i>L I I</i>): Logical input LI1 | | |
| ... | [...] (<i>. . .</i>): See the assignment conditions on page 138 | | |

Parameters described in this page can be accessed by:

DRI- > CONF > FULL > I_O- > L1-

| Code | Name / Description | Adjustment range | Factory setting |
|----------------|--|------------------|-----------------|
| L I - | [LI1 CONFIGURATION] | | |
| L I A | [LI1 assignment] | | |
| | Read-only parameter, cannot be configured. It displays all the functions that are assigned to input LI1 in order to check for multiple assignments. | | |
| n 0 | [No] (n 0): Not assigned | | |
| r U n | [Run] (r U n): Run Enable | | |
| F r d | [Forward] (F r d): Forward operation | | |
| r r S | [Reverse] (r r S): Reverse operation | | |
| r P S | [Ramp switching] (r P S): Ramp switching | | |
| J O G | [Jog] (J O G): Jog operation | | |
| U S P | [+Speed] (U S P): + speed | | |
| d S P | [- speed] (d S P): - speed | | |
| P S 2 | [2 preset speeds] (P S 2): 2 Preset speeds | | |
| P S 4 | [4 preset speeds] (P S 4): 4 Preset speeds | | |
| P S 8 | [8 preset speeds] (P S 8): 8 Preset speeds | | |
| r F C | [Ref. 2 switching] (r F C): Reference switching | | |
| n S t | [Freewheel stop] (n S t): Freewheel stop | | |
| d C I | [DC injection] (d C I): Injection DC stop | | |
| F S t | [Fast stop] (F S t): Fast stop | | |
| F L 0 | [Forced local] (F L 0): Forced local mode | | |
| r S F | [Fault reset] (r S F): Fault reset | | |
| t U L | [Auto-tuning] (t U L): Auto-tuning | | |
| S P n | [Ref. memo.] (S P n): Save reference | | |
| F L I | [Pre Fluxing] (F L I): Motor fluxing | | |
| P R U | [Auto / manual] (P R U): PI(D) auto-manu | | |
| P I S | [PID integral reset] (P I S): Integral shunting PI(D) | | |
| P r 2 | [2 preset PID ref.] (P r 2): 2 Preset PI(D) references | | |
| P r 4 | [4 preset PID ref.] (P r 4): 4 Preset PI(D) references | | |
| t L A | [Torque limitation] (t L A): Permanent torque limitation | | |
| E t F | [External fault] (E t F): External fault | | |
| r C A | [Output contact. fdbk] (r C A): Downstream contactor feedback | | |
| C n F 1 | [2 config. switching] (C n F 1): Configuration switching 1 | | |
| C n F 2 | [3 config. switching] (C n F 2): Configuration switching 2 | | |
| C H A 1 | [2 parameter sets] (C H A 1): Parameter switching 1 | | |
| C H A 2 | [3 parameter sets] (C H A 2): Parameter switching 2 | | |
| t L C | [Activ. Analog torque limitation] (t L C): Torque limitation: Activation (analog input) by a logic input | | |
| C C S | [Cmd switching] (C C S): Command channel switching | | |
| I n H | [Fault inhibition] (I n H): Fault inhibition | | |
| P S 16 | [16 preset speeds] (P S 16): 16 preset speeds | | |
| L C 2 | [Current limit 2] (L C 2): Current limitation switching | | |
| L A F | [Stop FW limit sw.] (L A F): Limit attained forward | | |
| L A r | [Stop RV limit sw.] (L A r): Limit attained reverse | | |
| r C b | [Ref 1B switching] (r C b): Reference channel switching (1 to 1B) | | |
| t r C | [Traverse control] (t r C): Traverse control | | |
| b C I | [Brake contact] (b C I): Brake logic input contact | | |
| S A F | [Stop FW limit sw.] (S A F): Stop switch forward | | |
| S A r | [Stop RV limit sw.] (S A r): Stop switch reverse | | |
| d A F | [Slowdown forward] (d A F): Slowdown attained forward | | |
| d A r | [Slowdown reverse] (d A r): Slowdown attained reverse | | |
| C L S | [Disable limit sw.] (C L S): Limits switches clearing | | |
| L E S | [Drive lock (Line contact. ctrl)] (L E S): Emergency stop | | |
| r t r | [Init. traverse ctrl.] (r t r): Reload traverse control | | |
| S n C | [Counter wobble] (S n C): Counter wobble synchronization | | |
| r P A | [Prod. reset] (r P A): Reset Product | | |
| S H 2 | [2 HSP] (S H 2): High Speed 2 | | |
| S H 4 | [4 HSP] (S H 4): High Speed 4 | | |
| L O I | [LO1] (L O I): Logical output LO1 | | |
| r 1 | [R1] (r 1): Relay R1 | | |
| r 2 | [R2] (r 2): Relay R2 | | |
| d O I | [DO1] (d O I): Analog/logical output DO1 | | |
| b t U C | [Bth visibilit.] (b t U C): Bluetooth visibility | | |
| D I r | [Regen. connection] (D I r): Operation with reversible unit | | |
| F J O G | [Jog] (F J O G): Function key jog assignment | | |
| F P S 1 | [Preset spd2] (F P S 1): Function key preset speed 1 assignment | | |
| F P S 2 | [Preset spd3] (F P S 2): Function key preset speed 2 assignment | | |

Parameters described in this page can be accessed by: DRI- > CONF > FULL > I_O- > L1-

| Code | Name / Description | Adjustment range | Factory setting |
|---|--|------------------|-----------------|
| <i>F P r 1</i> <i>F P r 2</i> <i>F U S P</i> <i>F d S P</i> <i>F t</i> <i>U S I</i> <i>d S I</i> <i>I L 0 1</i> ... <i>I L 1 0</i> <i>F b r n</i> | [PID ref. 2] (<i>F P r 1</i>): Function key preset PI 1 assignment [PID ref. 3] (<i>F P r 2</i>): Function key preset PI 2 assignment [+Speed] (<i>F U S P</i>): Function key faster assignment [-Speed] (<i>F d S P</i>): Function key slower assignment [T/K] (<i>F t</i>): Function key bumpless assignment [+speed around ref.] (<i>U S I</i>): + Speed around ref [-speed around ref.] (<i>d S I</i>): - Speed around ref [IL01] (<i>I L 0 1</i>): Function blocks: Logical Input 1 ... [IL10] (<i>I L 1 0</i>): Function blocks: Logical Input 10 [FB start] (<i>F b r n</i>): Function blocks: Run mode | | |
| <i>L 1 d</i> | [LI1 On Delay] This parameter is used to take account of the change of the logic input to state 1 with a delay that can be adjusted between 0 and 200 milliseconds, in order to filter out possible interference. The change to state 0 is taken into account without delay. | 0 to 200 ms | 0 ms |
| <i>I _ O -</i> | [INPUTS / OUTPUTS CFG] (continued) | | |
| <i>L 2 -</i> to <i>L 6 -</i> | [Lix CONFIGURATION] All the logic inputs available on the drive are processed as in the example for LI1 above, up to LI6. | | |
| <i>L 5 -</i> | [LA5 CONFIGURATION] Specific parameters for LI5 used as a pulse input. | | |
| <i>P I A</i> | [RP assignment] Read-only parameter, cannot be configured. It displays all the functions associated with the Pulse input in order to check, for example, for compatibility problems. Identical to [AI1 assignment] (<i>A I I A</i>) page 120 . | | |
| <i>P I L</i> | [RP min value] Pulse input scaling parameter of 0% in Hz * 10 unit. | 0 to 20.00 kHz | 0 kHz |
| <i>P F r</i> | [RP max value] Pulse input scaling parameter of 100% in Hz * 10 unit. | 0 to 20.00 kHz | 20.00 kHz |
| <i>P F I</i> | [RP filter] I/O ext Pulse input cutoff time of the low-filter. | 0 to 1,000 ms | 0 ms |
| <i>L A 1 -</i> <i>L A 2 -</i> | [LAX CONFIGURATION] The 2 analog inputs AI1 and AI2 on the drive could be used as LI inputs and are processed as in the example for LI1 above. | | |



These parameters only appear if the corresponding function has been selected in another menu. When the parameters can also be accessed and adjusted from within the configuration menu for the corresponding function, their description is detailed in these menus, on the pages indicated, to aid programming.

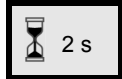

To change the assignment of this parameter, press the ENT key for 2 s.

Configuration of analog inputs and Pulse input

The minimum and maximum input values (in volts, mA, etc.) are converted to % in order to adapt the references to the application.

Minimum and maximum input values:

The minimum value corresponds to a reference of 0% and the maximum value to a reference of 100%. The minimum value may be greater than the maximum value:

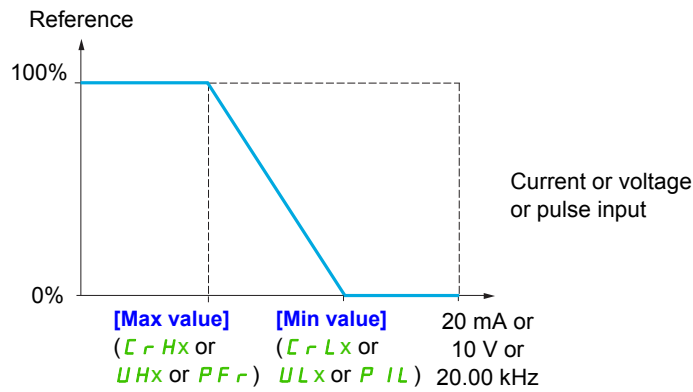
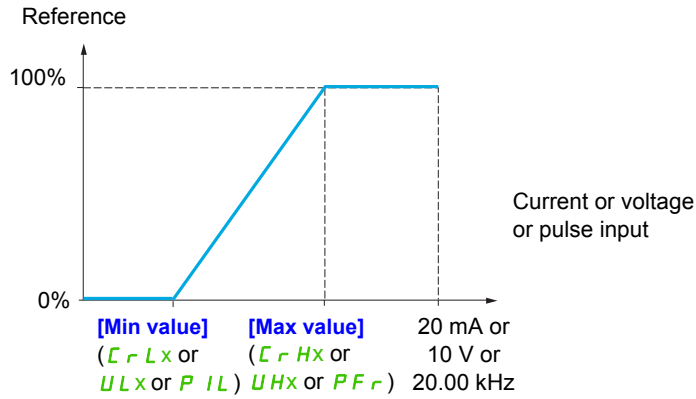

For +/- bidirectional inputs, the min. and max. are relative to the absolute value, for example +/- 2 to 8 V.

Range (output values): For analog inputs only:

This parameter is used to configure the reference range to [0% → 100%] or [-100% → +100%] in order to obtain a bidirectional output from a unidirectional input.

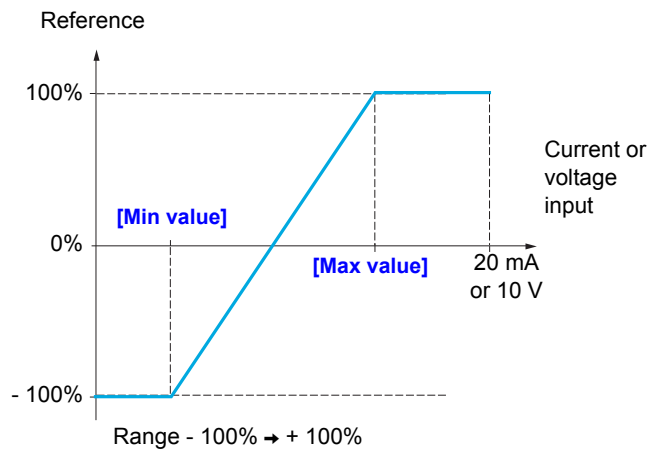
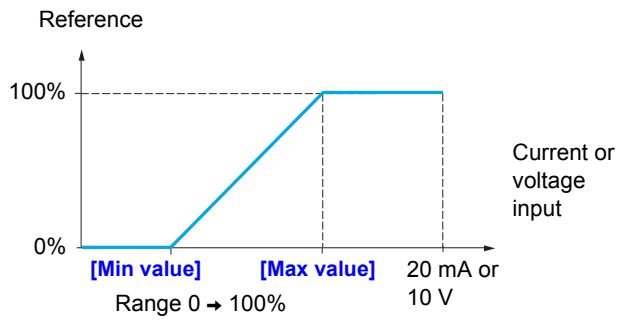

Parameters described in this page can be accessed by:

DRI- > CONF > FULL > I_O- > LAI-

| Code | Name / Description | Adjustment range | Factory setting |
|------|--|------------------|-------------------------|
| I_O- | [INPUTS / OUTPUTS CFG] (continued) | | |
| LAI- | [LAI CONFIGURATION] | | |
| b5P | [Reference template] | | [Standard] (b5d) |
| b5d | [Standard] (b5d) | | |
| () | <p>At zero reference the frequency = LSP</p> | | |
| bL5 | [Pedestal] (bL5) | | |
| () | <p>At reference = 0 to LSP the frequency = LSP</p> | | |
| bN5 | [Deadband] (bN5) | | |
| () | <p>At reference = 0 to LSP the frequency = 0</p> | | |
| bN5D | [Deadband 0] (bN5D) | | |
| () | <p>This operation is the same as [Standard] (b5d), except that in the following cases at zero reference, the frequency = 0: The signal is less than [Min value], which is greater than 0 (example 1 V on a 2 - 10 V input) The signal is greater than [Min value], which is greater than [Max value] (example: 11 V on a 10 - 0 V input). If the input range is configured as "bidirectional", operation remains identical to [Standard] (b5d). This parameter defines how the speed reference is taken into account, for analog inputs and Pulse input only. In the case of the PID regulator, this is the PID output reference. The limits are set by the [Low speed] (L5P) and [High speed] (H5P) parameters, page 75.</p> | | |

() Parameter that can be modified during operation or when stopped.

Delinearization: For analog inputs only:

The input can be delinearized by configuring an intermediate point on the input/output curve of this input:

For range 0 → 100%

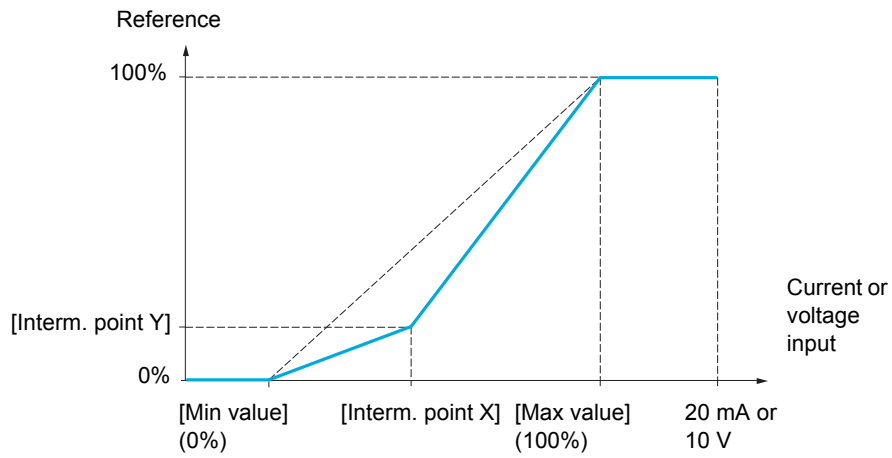

Note: For [Interm. point X], 0% corresponds to [Min value] and 100% to [Max value].

For range -100% → 100%

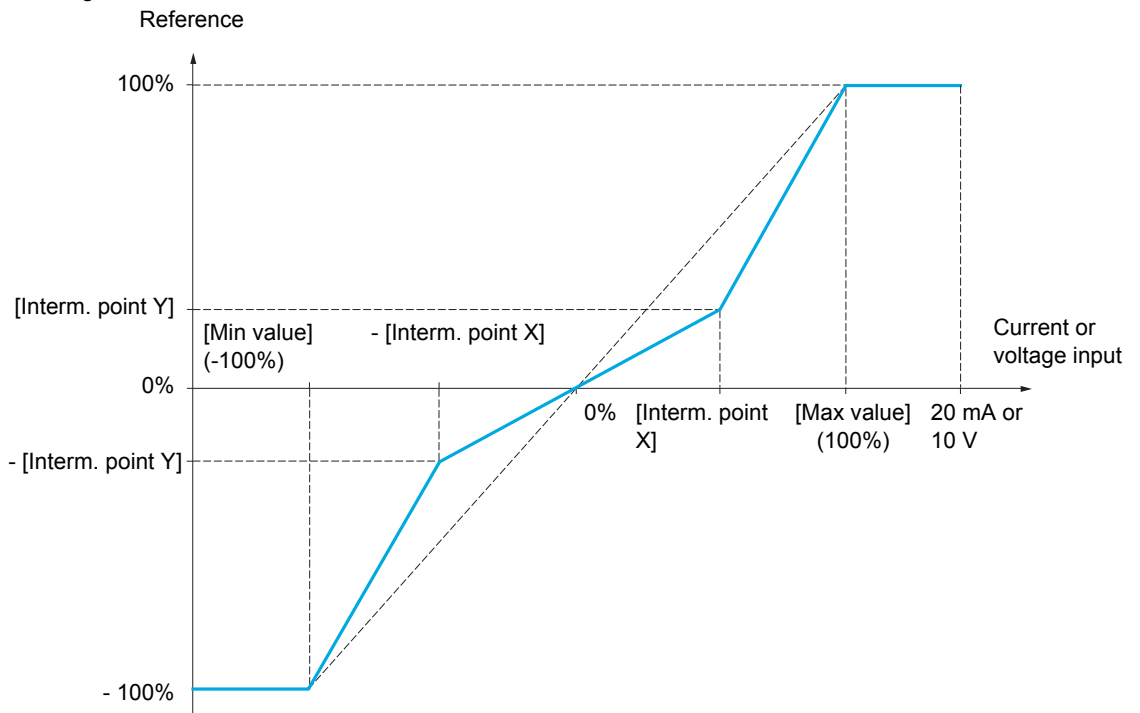

Parameters described in this page can be accessed by:

DRI- > CONF > FULL > I_O- > AI1-

| Code | Name / Description | Adjustment range | Factory setting |
|----------------|--|------------------|---|
| A I I - | [AI1 CONFIGURATION] | | |
| A I I A | [AI1 assignment] Read-only parameter, cannot be configured. It displays all the functions associated with input AI1 in order to check, for example, for compatibility problems. | | |
| <i>n D</i> | [No] (<i>n D</i>): Not assigned | | |
| <i>A O 1</i> | [AO1 assignment] (<i>A O 1</i>): Analog output AO1 | | |
| <i>F r 1</i> | [Ref.1 channel] (<i>F r 1</i>): Reference source 1 | | |
| <i>F r 2</i> | [Ref.2 channel] (<i>F r 2</i>): Reference source 2 | | |
| <i>S R 2</i> | [Summing ref. 2] (<i>S R 2</i>): Summing reference 2 | | |
| <i>P I F</i> | [PID feedback] (<i>P I F</i>): PI feedback (PI control) | | |
| <i>t A A</i> | [Torque limitation] (<i>t A A</i>): Torque limitation: Activation by an analog value | | |
| <i>d R 2</i> | [Subtract. ref. 2] (<i>d R 2</i>): Subtracting reference 2 | | |
| <i>P I N</i> | [Manual PID ref.] (<i>P I N</i>): Manual speed reference of the PI(D) regulator (auto-man) | | |
| <i>F P I</i> | [PID speed ref.] (<i>F P I</i>): Speed reference of the PI(D) regulator (predictive reference) | | |
| <i>S R 3</i> | [Summing ref. 3] (<i>S R 3</i>): Summing reference 3 | | |
| <i>F r 1 b</i> | [Ref.1B channel] (<i>F r 1 b</i>): Reference source 1B | | |
| <i>d R 3</i> | [Subtract. ref. 3] (<i>d R 3</i>): Subtracting reference 3 | | |
| <i>F L O C</i> | [Forced local] (<i>F L O C</i>): Forced local reference source | | |
| <i>M A 2</i> | [Ref.2 multiplier] (<i>M A 2</i>): Multiplying reference 2 | | |
| <i>M A 3</i> | [Ref. 3 multiplier] (<i>M A 3</i>): Multiplying reference 3 | | |
| <i>P E S</i> | [Weight input] (<i>P E S</i>): Hoisting: External weight measurement function | | |
| <i>I A 0 1</i> | [IA01] (<i>I A 0 1</i>): Function blocks: Analog Input 01 | | |
| ... | ... | | |
| <i>I A 1 0</i> | [IA10] (<i>I A 1 0</i>): Function blocks: Analog Input 10 | | |
| A I I t | [AI1 Type] | | [Voltage] (<i>I O U</i>) |
| <i>I O U</i> | [Voltage] (<i>I O U</i>): Positive voltage input (negative values are interpreted as zero: the input is unidirectional) | | |
| U I L 1 | [AI1 min value] AI1 voltage scaling parameter of 0%. | 0 to 10.0 V | 0 V |
| U I H 1 | [AI1 max value] AI1 voltage scaling parameter of 100%. | 0 to 10.0 V | 10.0 V |
| A I I F | [AI1 filter] Interference filtering. | 0 to 10.00 s | 0 s |
| A I I L | [AI1 range] | | [0 - 100%] (<i>P O S</i>) |
| <i>P O S</i> | [0 - 100%] (<i>P O S</i>): Positive logical | | |
| <i>n E G</i> | [+/- 100%] (<i>P O S</i>): Positive and negative logical | | |
| A I I E | [AI1 Interm. point X] Input delinearization point coordinate. Percentage of the physical input signal. 0% corresponds to [AI1 min value] (<i>U I L 1</i>). 100% corresponds to [AI1 max value] (<i>U I H 1</i>). | 0 to 100% | 0% |
| A I I S | [AI1 Interm. point Y] Output delinearization point coordinate (frequency reference). Percentage of the internal frequency reference corresponding to the [AI1 Interm. point X] (<i>A I I E</i>) percentage of physical input signal. | 0 to 100% | 0% |
| I _ O - | [INPUTS / OUTPUTS CFG] (continued) | | |
| A I 2 - | [AI2 CONFIGURATION] | | |
| A I 2 A | [AI2 assignment] Identical to [AI1 assignment] (<i>A I I A</i>) page 120. | | |
| A I 2 t | [AI2 Type] | | [Voltage +/-] (<i>n I O U</i>) |
| <i>I O U</i> | [Voltage] (<i>I O U</i>): 0 - 10 V | | |
| U I L 2 | [AI2 min value] AI2 voltage scaling parameter of 0%. | 0 to 10.0 V | 0 V |

Parameters described in this page can be accessed by:

DRI- > CONF > FULL > I_O- > AI2-

| Code | Name / Description | Adjustment range | Factory setting |
|--|--|------------------|---|
| <i>U I H 2</i> | [AI2 max. value] AI2 voltage scaling parameter of 100%. | 0 to 10.0 V | 10.0 V |
| <i>R I 2 F</i> | [AI2 filter] Interference filtering. | 0 to 10.00 s | 0 s |
| <i>R I 2 E</i> | [AI2 Interm. point X] Input delinearization point coordinate. Percentage of the physical input signal. 0% corresponds to [Min value] if the range is 0 → 100%. 0% corresponds to $\frac{\text{[Max value]} + \text{[Min value]}}{2}$ if the range is -100% → +100%. 100% corresponds to [Max value] . | 0 to 100% | 0% |
| <i>R I 2 S</i> | [AI2 Interm. point Y] Output delinearization point coordinate (frequency reference). Percentage of the internal frequency reference corresponding to the [AI2 Interm. point X] (<i>R I 2 E</i>) percentage of physical input signal. | 0 to 100% | 0% |
| I_O- | [INPUTS / OUTPUTS CFG] (continued) | | |
| <i>R I 3 -</i> | [AI3 CONFIGURATION] | | |
| <i>R I 3 A</i> | [AI3 assignment] Identical to [AI1 assignment] (<i>R I 1 A</i>) page 120. | | |
| <i>R I 3 E</i> <i>OR</i> | [AI3 Type] [Current] (<i>OR</i>): 0 - 20 mA | | [Voltage +/-] (<i>n I O U</i>) |
| <i>C r L 3</i> | [AI3 min. value] AI3 current scaling parameter of 0%. | 0 to 20.0 mA | 0 mA |
| <i>C r H 3</i> | [AI3 max. value] AI3 current scaling parameter of 100%. | 0 to 20.0 mA | 20.0 mA |
| <i>R I 3 F</i> | [AI3 filter] Interference filtering. | 0 to 10.00 s | 0 s |
| <i>R I 3 L</i> <i>P O S</i> <i>n E G</i> | [AI3 range] [0 - 100%] (<i>P O S</i>): Unidirectional input [+/- 100%] (<i>n E G</i>): Bidirectional input Example: On a 4 - 20 mA input. 4 mA corresponds to reference -100%. 12 mA corresponds to reference 0%. 20 mA corresponds to reference +100%. Since AI3 is, in physical terms, a bidirectional input, the [+/- 100%] (<i>n E G</i>) configuration must only be used if the signal applied is unidirectional. A bidirectional signal is not compatible with a bidirectional configuration. | | [0 - 100%] (<i>P O S</i>) |
| <i>R I 3 E</i> | [AI3 Interm. point X] Input delinearization point coordinate. Percentage of the physical input signal. 0% corresponds to [Min value] (<i>C r L 3</i>) if the range is 0 → 100%. 0% corresponds to $\frac{\text{[AI3 max. value]} (\text{C r H 3}) - \text{[AI3 min. value]} (\text{C r L 3})}{(\text{C r L 3})}$ if the range is -100% → +100%. 100% corresponds to [AI3 max. value] (<i>C r H 3</i>). | 0 to 100% | 0% |
| <i>R I 3 S</i> | [AI3 Interm. point Y] Output delinearization point coordinate (frequency reference). Percentage of the internal frequency reference corresponding to the [AI3 Interm. point X] (<i>R I 3 E</i>) percentage of physical input signal. | 0 to 100% | 0% |
| I_O- | [INPUTS / OUTPUTS CFG] (continued) | | |
| <i>R U I -</i> | [VIRTUAL AI1] | | |
| <i>R U I A</i> | [AIV1 assignment] Virtual analog input 1 via the jog dial available on the front side of the product. Identical to [AI1 assignment] (<i>R I 1 A</i>) page 120. | | |

Parameters described in this page can be accessed by:

DRI- > CONF > FULL > I_O- > AU2-

| Code | Name / Description | Adjustment range | Factory setting |
|---------|---|------------------|-------------------|
| I_O- | [INPUTS / OUTPUTS CFG] (continued) | | |
| AU2- | [VIRTUAL AI2] | | |
| AU2A | [AIV2 assignment] Possible assignments for [AI virtual 2] (A I U 2) : Virtual analog input 2 via communication channel, to be configured with [AI2 net. channel] (A I C 2) . Identical to [AIV1 assignment] (A U I A) page 121 . | | |
| A I C 2 | [AI2 net. Channel] [VIRTUAL AI2] (A U 2 A) source channel. This parameter can also be accessed in the [PID REGULATOR] (P I d -) submenu page 196 . Scale: The value 8192 transmitted by this input is equivalent to 10 V on a 10 V input. | | [No] (n 0) |
| ★ | <p>n 0 [No] (n 0): Not assigned</p> <p>n d b [Modbus] (n d b): Integrated Modbus</p> <p>C A n [CANopen] (C A n): Integrated CANopen®</p> <p>n E t [Com. card] (n E t): Communication card (if inserted)</p> | | |



These parameters only appear if the corresponding function has been selected in another menu. When the parameters can also be accessed and adjusted from within the configuration menu for the corresponding function, their description is detailed in these menus, on the pages indicated, to aid programming.

| Code | Name / Description | Adjustment range | Factory setting |
|--------------|---|------------------|------------------------|
| I _ 0 - | [INPUTS / OUTPUTS CFG] (continued) | | |
| r - | [R1 CONFIGURATION] | | |
| r | [R1 Assignment] | | [No drive flt] (F L E) |
| n 0 | [No] (n 0): Not assigned | | |
| F L E | [No drive flt] (F L E): Drive fault detection status (relay normally energized, and de-energized if there is a trip) | | |
| r U n | [Drv running] (r U n): Drive running | | |
| F E A | [Freq. Th. attain.] (F E A): Frequency threshold attained ([Freq. threshold] (F E d) page 89) | | |
| F L A | [HSP attain.] (F L A): High speed attained | | |
| C E A | [I attained] (C E A): Current threshold attained ([Current threshold] (C E d) page 89) | | |
| S r A | [Freq.ref.att] (S r A): Frequency reference attained | | |
| t S A | [Th.mot. att.] (t S A): Motor 1 thermal state attained | | |
| P E E | [PID error al] (P E E): PID error alarm | | |
| P F A | [PID fdbk al] (P F A): PID feedback alarm | | |
| F 2 A | [Freq. Th 2 attain.] (F 2 A): Frequency threshold 2 attained ([Freq. threshold 2] (F 2 d) page 89) | | |
| t A d | [Th. drv. att.] (t A d): Drive thermal state attained | | |
| U L A | [Pro.Undload] (U L A): Underload alarm | | |
| O L A | [Ovld.P.Alrm] (O L A): Overload alarm | | |
| r S d A | [Rope slack] (r S d A): Rope slack (see [Rope slack config.] (r S d) parameter page 190) | | |
| t E H A | [High tq. att.] (t E H A): Motor torque overshooting high threshold [High torque thd.] (t E H) page 89 | | |
| t E L A | [Low tq. att.] (t E L A): Motor torque undershooting low threshold [Low torque thd.] (t E L) page 89 | | |
| n F r d | [Forward] (n F r d): Motor in forward rotation | | |
| n r r S | [Reverse] (n r r S): Motor in reverse rotation | | |
| t S 2 | [Th.mot2 att] (t S 2): Motor 2 thermal threshold (TTD2) reached | | |
| t S 3 | [Th.mot3 att] (t S 3): Motor 3 thermal threshold (TTD3) reached | | |
| A t S | [Neg Torque] (A t S): Negative torque (braking) | | |
| C n F 0 | [Cnfg.0 act.] (C n F 0): Configuration 0 active | | |
| C n F 1 | [Cnfg.1 act.] (C n F 1): Configuration 1 active | | |
| C n F 2 | [Cnfg.2 act.] (C n F 2): Configuration 2 active | | |
| C F P 1 | [Set 1 active] (C F P 1): Parameter set 1 active | | |
| C F P 2 | [Set 2 active] (C F P 2): Parameter set 2 active | | |
| C F P 3 | [Set 3 active] (C F P 3): Parameter set 3 active | | |
| d b L | [DC charged] (d b L): DC bus charging | | |
| b r S | [In braking] (b r S): Drive braking | | |
| P r n | [P. removed] (P r n): Drive locked by "Safe Torque Off" input | | |
| F 9 L A | [Fr.met. alar.] (F 9 L A): Measured speed threshold attained [Pulse warning thd.] (F 9 L) page 89 | | |
| n C P | [I present] (n C P): Motor current present | | |
| L S A | [Limit sw. att] (L S A): Limit switch attained | | |
| d L d A | [Load alarm] (d L d A): Load variation detection (see page 248) | | |
| A G 1 | [Alarm Grp 1] (A G 1): Alarm group 1 | | |
| A G 2 | [Alarm Grp 2] (A G 2): Alarm group 2 | | |
| A G 3 | [Alarm Grp 3] (A G 3): Alarm group 3 | | |
| P L A | [LI6=PTC al.] (P L A): LI6 = PTCL alarm | | |
| E F A | [Ext. fault al] (E F A): External fault alarm | | |
| U S A | [Under V. al.] (U S A): Undervoltage alarm | | |
| U P A | [Uvoltage warn] (U P A): Undervoltage threshold | | |
| t H A | [Al. °C drv] (t H A): Drive overheating | | |
| S S A | [Lim T/I att.] (S S A): Torque limit alarm | | |
| t J A | [IGBT al.] (t J A): Thermal junction alarm | | |
| b O A | [Brake R. al.] (b O A): Torque regulation time-out alarm | | |
| A P 3 | [AI3 Al. 4-20] (A P 3): AI3 4-20 mA loss alarm | | |
| r d Y | [Brake R. al.] (r d Y): Torque regulation time-out alarm | | |
| r - | [R1 CONFIGURATION] (continued) | | |
| r d (1) | [R1 Delay time] | 0 to 60,000 ms | 0 ms |
| | The change in state only takes effect once the configured time has elapsed, when the information becomes true. The delay cannot be set for the [No drive flt] (F L E) assignment, and remains at 0. | | |
| r S | [R1 Active at] | | [1] (P O S) |
| | Configuration of the operating logic: | | |
| P O S | [1] (P O S): State 1 when the information is true | | |
| n E G | [0] (n E G): State 0 when the information is true | | |
| | Configuration [1] (P O S) cannot be modified for the [No drive flt] (F L E) assignment. | | |

Parameters described in this page can be accessed by:

DRI- > CONF > FULL > I_O- > R1-

| Code | Name / Description | Adjustment range | Factory setting |
|---------------------|---|--------------------|-----------------------------|
| <i>r 1H</i> | [R1 Holding time] The change in state only takes effect once the configured time has elapsed, when the information becomes false. The holding time cannot be set for the [No drive fit] (<i>FL E</i>) assignment, and remains at 0. | 0 to 9,999 ms | 0 ms |
| <i>I_D -</i> | [INPUTS / OUTPUTS CFG] (continued) | | |
| <i>r 2 -</i> | [R2 CONFIGURATION] | | |
| <i>r 2</i> | [R2 Assignment] Identical to [R1 Assignment] (<i>r 1</i>) page 123 with the addition of: <i>b L C</i> [Brk control] (<i>b L C</i>): Brake contactor control <i>L L C</i> [Input cont.] (<i>L L C</i>): Line contactor control <i>O C C</i> [Output cont.] (<i>O C C</i>): Output contactor control <i>E b D</i> [End reel] (<i>E b D</i>): End of reel (traverse control function) <i>t 5 Y</i> [Sync. wobble] (<i>t 5 Y</i>): "Counter wobble" synchronization <i>d C D</i> [DC charging] (<i>d C D</i>): DC bus precharging contactor control <i>O L O 1</i> [OL01] (<i>O L O 1</i>): Function blocks: Logical Output 01 ... <i>O L 10</i> [OL10] (<i>O L 10</i>): Function blocks: Logical Output 10 | | [No] (<i>n 0</i>) |
| <i>r 2 d</i> (1) | [R2 Delay time] The delay cannot be set for the [No drive fit] (<i>FL E</i>), [Brk control] (<i>b L C</i>), [Output cont.] (<i>O C C</i>) and [Input cont.] (<i>L L C</i>) assignments, and remains at 0. The change in state only takes effect once the configured time has elapsed, when the information becomes true. | 0 to 60,000 ms | 0 ms |
| <i>r 2 S</i> | [R2 Active at] Configuration of the operating logic: <i>P O S</i> [1] (<i>P O S</i>): State 1 when the information is true <i>n E G</i> [0] (<i>n E G</i>): State 0 when the information is true The configuration [1] (<i>P O S</i>) cannot be modified for the [No drive fit] (<i>FL E</i>), [Brk control] (<i>b L C</i>), [DC charging] (<i>d C D</i>), and [Input cont.] (<i>L L C</i>) assignments. | | [1] (<i>P O S</i>) |
| <i>r 2 H</i> | [R2 Holding time] The holding time cannot be set for the [No drive fit] (<i>FL E</i>), [Brk control] (<i>b L C</i>) and [Input cont.] (<i>L L C</i>) assignments, and remains at 0. The change in state only takes effect once the configured time has elapsed, when the information becomes false. | 0 to 9,999 ms | 0 ms |
| <i>I_D -</i> | [INPUTS / OUTPUTS CFG] (continued) | | |
| <i>L O 1 -</i> | [LO1 CONFIGURATION] | | |
| <i>L O 1</i> | [LO1 assignment] Identical to [R1 Assignment] (<i>r 1</i>) page 123 with the addition of (shown for information only as these selections can only be configured in the [APPLICATION FUNCT.] (<i>F U n -</i>) menu: <i>b L C</i> [Brk control] (<i>b L C</i>): Brake contactor control <i>L L C</i> [Input cont.] (<i>L L C</i>): Line contactor control <i>O C C</i> [Output cont.] (<i>O C C</i>): Output contactor control <i>E b D</i> [End reel] (<i>E b D</i>): End of reel(traverse control function) <i>t 5 Y</i> [Sync. wobble] (<i>t 5 Y</i>): "Counter wobble" synchronization <i>d C D</i> [DC charging] (<i>d C D</i>): DC bus precharging contactor control <i>O L O 1</i> [OL01] (<i>O L O 1</i>): Function blocks: Logical Output 01 ... <i>O L 10</i> [OL10] (<i>O L 10</i>): Function blocks: Logical Output 10 | | [No] (<i>n 0</i>) |
| <i>L O 1 d</i> | [LO1 delay time] The delay cannot be set for the [No drive fit] (<i>FL E</i>), [Brk control] (<i>b L C</i>), [Output cont.] (<i>O C C</i>) and [Input cont.] (<i>L L C</i>) assignments, and remains at 0. The change in state only takes effect once the configured time has elapsed, when the information becomes true. | 0 to 60,000 ms (1) | 0 ms |
| <i>L O 1 S</i> | [LO1 active at] Configuration of the operating logic: <i>P O S</i> [1] (<i>P O S</i>): State 1 when the information is true <i>n E G</i> [0] (<i>n E G</i>): State 0 when the information is true The configuration [1] (<i>P O S</i>) cannot be modified for the [No drive fit] (<i>FL E</i>), [Brk control] (<i>b L C</i>) and [Input cont.] (<i>L L C</i>) assignments. | | [1] (<i>P O S</i>) |

Parameters described in this page can be accessed by:

DRI- > CONF > FULL > I_O- > LO1-

| Code | Name / Description | Adjustment range | Factory setting |
|----------------|--|------------------|-----------------|
| <i>L O I H</i> | [LO1 holding time] The holding time cannot be set for the [No drive flt] (<i>F L E</i>), [Brk control] (<i>b L E</i>) and [Input cont] (<i>L L E</i>) assignments, and remains at 0. The change in state only takes effect once the configured time has elapsed, when the information becomes false. | 0 to 9,999 ms | 0 |

(1) 0 to 9,999 ms then 10.00 to 60.00 s on the integrated display terminal.

Parameters described in this page can be accessed by:

DRI- > CONF > FULL > I_O- > DO1-

Use of analog output AO1 as a logic output

Analog output AO1 can be used as a logic output, by assigning DO1. In this case, when set to 0, this output corresponds to the AO1 min. value (0 V, or 0 mA for example), and when set to 1 to the AO1 max. value (10 V, or 20 mA for example).

The electrical characteristics of this analog output remain unchanged. As these characteristics are different from logic output characteristics, check that it is still compatible with the intended application.

| Code | Name / Description | Adjustment range | Factory setting |
|------|--|--------------------|--------------------|
| I_O- | [INPUTS / OUTPUTS CFG] (continued) | | |
| DO1- | [DO1 CONFIGURATION] | | |
| DO1 | [DO1 assignment] Identical to [R1 Assignment] (r I) page 123 with the addition of (shown for information only as these selections can only be configured in the [APPLICATION FUNCT.] (Fun-) menu: b L C [Brk control] (b L C): Brake contactor control L L C [Input cont.] (L L C): Line contactor control O C C [Output cont.] (O C C): Output contactor control E b O [End reel] (E b O): End of reel(traverse control function) t S Y [Sync. wobble] (t S Y): "Counter wobble" synchronization d C O [DC charging] (d C O): DC bus precharging contactor control O L O 1 [OL01] (O L O 1): Function blocks: Logical Output 01 ... O L 10 [OL10] (O L 10): Function blocks: Logical Output 10 | | [No] (n O) |
| DO1d | [DO1 delay time] The delay cannot be set for the [No drive flt] (F L t), [Brk control] (b L C), [Output cont.] (O C C) and [Input cont.] (L L C) assignments, and remains at 0. The change in state only takes effect once the configured time has elapsed, when the information becomes true. | 0 to 60,000 ms (1) | 0 ms |
| DO1S | [DO1 active at] Configuration of the operating logic: P O S [1] (P O S): State 1 when the information is true n E G [0] (n E G): State 0 when the information is true The configuration [1] (P O S) cannot be modified for the [No drive flt] (F L t), [Brk control] (b L C) and [Input cont.] (L L C) assignments. | | [1] (P O S) |
| DO1H | [DO1 holding time] The holding time cannot be set for the [No drive flt] (F L t), [Brk control] (b L C) and [Input cont.] (L L C) assignments, and remains at 0. The change in state only takes effect once the configured time has elapsed, when the information becomes false. | 0 to 9,999 ms | 0 ms |

(1) 0 to 9,999 ms then 10.00 to 60.00 s on the integrated display terminal.

Configuration of analog output

Minimum and maximum values (output values):

The minimum output value, in volts, corresponds to the lower limit of the assigned parameter and the maximum value corresponds to its upper limit. The minimum value may be greater than the maximum value.

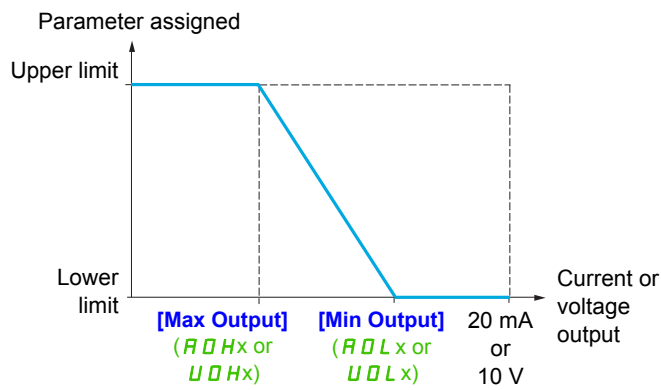
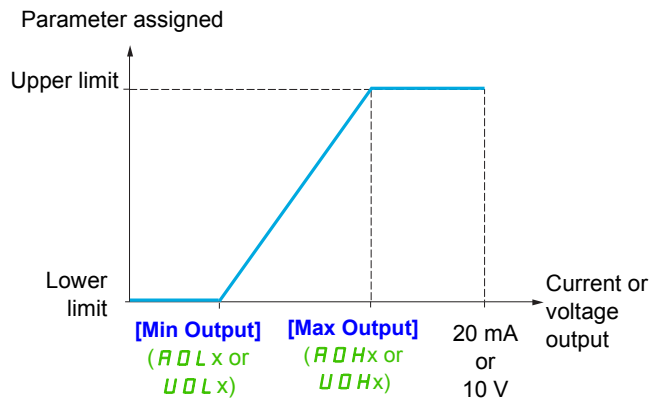

Scaling of the assigned parameter

The scale of the assigned parameter can be adapted in accordance with requirements by modifying the values of the lower and upper limits by means of two parameters for each analog output.

These parameters are given in %. 100% corresponds to the total variation range of the configured parameter, so: $100\% = \text{upper limit} - \text{lower limit}$. For example, **[Sign. torque] (5 L 9)** which varies between -3 and +3 times the rated torque, 100% corresponds to 6 times the rated torque.

- The **[Scaling AOx min] (R 5 L x)** parameter modifies the lower limit: $\text{new value} = \text{lower limit} + (\text{range} \times \text{ASLx})$. The value 0% (factory setting) does not modify the lower limit.
- The **[Scaling AOx max] (R 5 H x)** parameter modifies the upper limit: $\text{new value} = \text{lower limit} + (\text{range} \times \text{ASHx})$. The value 100% (factory setting) does not modify the upper limit.
- **[Scaling AOx min] (R 5 L x)** must always be lower than **[Scaling AOx max] (R 5 H x)**.

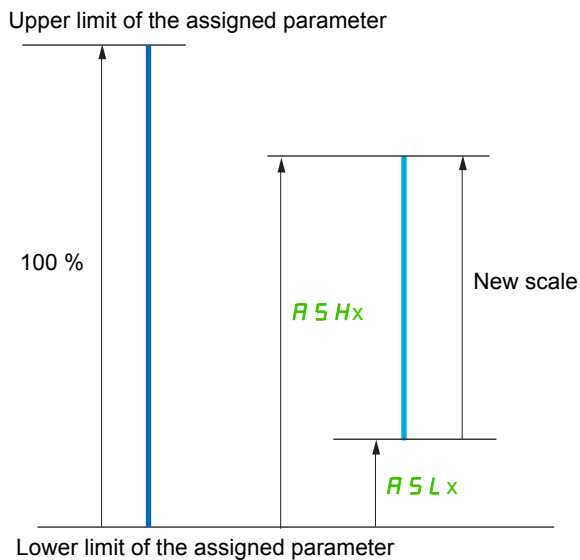

Application example 2

The value of the motor current at the AO1 output is to be transferred with 0 - 20 mA, range 2 In motor, In motor being the equivalent of a 0.8 In drive.

The **[I motor] (D L r)** parameter varies between 0 and 2 times the rated drive current, or a range of 2.5 times the rated drive current.

[Scaling AO1 min] (R 5 L I) must not modify the lower limit, which therefore remains at its factory setting of 0%.

[Scaling AO1 max] (R 5 H I) must modify the upper limit by 0.5x the rated motor torque, or $100 - 100/5 = 80\%$ (new value = lower limit + (range x ASH1)).

| Code | Name / Description | Adjustment range | Factory setting |
|------|--|------------------|-----------------|
| I_O- | [INPUTS / OUTPUTS CFG] (continued) | | |
| AO1- | [AO1 CONFIGURATION] | | |
| AO1 | [AO1 assignment] | | [No] (n0) |
| n0 | [No] (n0): Not assigned | | |
| OCr | [I motor] (OCr): Current in the motor, between 0 and 2 In (In = rated drive current indicated in the Installation manual and on the drive nameplate) | | |
| OFr | [Motor freq.] (OFr): Output frequency, from 0 to [Max frequency] (EFr) | | |
| OF5 | [Sig. o/p freq.] (OF5): Signed output frequency, between - [Max frequency] (EFr) and + [Max frequency] (EFr) | | |
| ORP | [Ramp out.] (ORP): From 0 to [Max frequency] (EFr) | | |
| Er9 | [Motor torq.] (Er9): Motor torque, between 0 and 3 times the rated motor torque | | |
| SE9 | [Sign. torque] (SE9): Signed motor torque, between -3 and +3 times the rated motor torque. The + sign corresponds to the motor mode and the - sign to the generator mode (braking). | | |
| OR5 | [sign ramp] (OR5): Signed ramp output, between - [Max frequency] (EFr) and + [Max frequency] (EFr). | | |
| OPS | [PID ref.] (OPS): PID regulator reference between [Min PID reference] (PIP1) and [Max PID reference] (PIP2). | | |
| OPF | [PID feedbk] (OPF): PID regulator feedback between [Min PID feedback] (PIF1) and [Max PID feedback] (PIF2) | | |
| OPE | [PID error] (OPE): PID regulator error between- 5 % and + 5 % of (([Max PID feedback] (PIF2) - [Min PID feedback] (PIF1)) | | |
| OP1 | [PID output] (OP1): PID regulator output between [Low speed] (L5P) and [High speed] (H5P) | | |
| OPr | [Mot. power] (OPr): Motor power, between 0 and 2.5 times [Rated motor power] (nPr) | | |
| UOP | [Motor volt.] (UOP): Voltage applied to the motor, between 0 and [Rated motor volt.] (Un5) | | |
| EHr | [Mot thermal] (EHr): Motor thermal state, between 0 and 200% of the rated thermal state | | |
| EHr2 | [Mot therm2] (EHr2): Motor thermal state 2, between 0 and 200 % of the rated thermal state | | |
| EHr3 | [Mot therm3] (EHr3): Motor thermal state 3, between 0 and 200% of the rated thermal state | | |
| EHd | [Drv thermal] (EHd): Drive thermal state, between 0 and 200% of the rated thermal state | | |
| ErL | [Torque lim.] (ErL): Torque limit, between 0 and 3 times the rated motor torque | | |
| DO1 | [dO1] (dO1): Assignment to a logic output. This assignment can only appear if [DO1 assignment] (dDI) has been assigned. This is the only possible choice in this case, and is only displayed for informational purposes. | | |
| ErNS | [Torque 4Q] (ErNS): Signed motor torque, between -3 and +3 times the rated motor torque. The + sign and the - sign correspond to the physical direction of the torque, regardless of mode (motor or generator). | | |
| OA01 | [OA01] (OA01): Function blocks: Analog Output 01 | | |
| ... | ... | | |
| OA10 | [OA10] (OA10): Function blocks: Analog Output 10 | | |
| AO1E | [AO1 Type] | | [Current] (OA) |
| IOU | [Voltage] (IOU): Voltage output | | |
| OA | [Current] (OA): Current output | | |
| ADLI | [AO1 min Output] | 0 to 20.0 mA | 0 mA |
| ★ | This parameter can be accessed if [AO1 Type] (AO1E) is set to [Current] (OA). | | |
| ADHI | [AO1 max Output] | 0 to 20.0 mA | 20.0 mA |
| ★ | This parameter can be accessed if [AO1 Type] (AO1E) is set to [Current] (OA). | | |
| UDLI | [AO1 min Output] | 0 to 10.0 V | 0 V |
| ★ | This parameter can be accessed if [AO1 Type] (AO1E) is set to [Voltage] (IOU). | | |
| UDHI | [AO1 max Output] | 0 to 10.0 V | 10.0 V |
| ★ | This parameter can be accessed if [AO1 Type] (AO1E) is set to [Voltage] (IOU). | | |
| ASLI | [Scaling AO1 min] | 0 to 100.0% | 0% |
| | Scaling of the lower limit of the assigned parameter, as a % of the maximum possible variation. | | |
| ASHI | [Scaling AO1 max] | 0 to 100.0% | 100.0% |
| | Scaling of the upper limit of the assigned parameter, as a % of the maximum possible variation. | | |
| AOIF | [AO1 Filter] | 0 to 10.00 s | 0 s |
| | Interference filtering. This parameter is forced to 0 if [AO1 assignment] (AO1) is set to [dO1] (dDI). | | |



These parameters only appear if the corresponding function has been selected in another menu. When the parameters can also be accessed and adjusted from within the configuration menu for the corresponding function, their description is detailed in these menus, on the pages indicated, to aid programming.

Parameters described in this page can be accessed by:

DRI- > CONF > FULL > I_O- > A1C-

The following submenus group the alarms into 1 to 3 groups, each of which can be assigned to a relay or a logic output for remote signaling. These groups can also be displayed on the graphic display terminal (see [\[3.3 MONITORING CONFIG.\] \(ΠCF -\)](#) menu page [266](#)) and viewed via the [\[1.2 MONITORING\] \(ΠDn -\)](#) menu page [41](#).

When one or a number of alarms selected in a group occurs, this alarm group is activated.

| Code | Name / Description |
|--------------|---|
| I_O - | [INPUTS / OUTPUTS CFG] (continued) |
| A1C - | [ALARM GRP1 DEFINITION] |
| | Selection to be made from the following list: <i>PLA</i> [LI6=PTC al.] (<i>PLA</i>): LI6 = PTCL alarm <i>EFA</i> [Ext. fault al.] (<i>EFA</i>): External fault alarm <i>USA</i> [Under V. al.] (<i>USA</i>): Undervoltage alarm <i>CEA</i> [I attained] (<i>CEA</i>): Current threshold attained ([Current threshold] (CEd) page 89) <i>FtA</i> [Freq.Th.att.] (<i>FtA</i>): Frequency threshold attained ([Freq. threshold] (Ftd) page 89) <i>F2A</i> [Freq. Th. 2 attain.] (<i>F2A</i>): Frequency threshold 2 attained ([Freq. Th. 2 attain] (F2d) page 89) <i>SrA</i> [Freq.ref.att.] (<i>SrA</i>): Frequency reference attained <i>t5A</i> [Th.mot. att.] (<i>t5A</i>): Motor 1 thermal state attained <i>t52</i> [Th.mot2 att.] (<i>t52</i>): Motor 2 thermal state attained <i>t53</i> [Th.mot3 att.] (<i>t53</i>): Motor 3 thermal state attained <i>UPA</i> [Uvolt warn] (<i>UPA</i>): Undervoltage threshold <i>FLA</i> [HSP attain.] (<i>FLA</i>): High speed attained <i>tHA</i> [Al. °C drv] (<i>tHA</i>): Drive overheating <i>PEE</i> [[PID error al] (<i>PEE</i>): PID error alarm <i>PFA</i> [PID fdbk al.] (<i>PFA</i>): PID feedback alarm <i>AP3</i> [AI3 Al. 4-20] (<i>AP3</i>): Alarm indicating absence of 4-20 mA signal on input AI3 <i>SSA</i> [Lim T/I att.] (<i>SSA</i>): Torque limit alarm <i>tAd</i> [Th. drv. att.] (<i>tAd</i>): Drive thermal state attained <i>tJA</i> [IGBT alarm] (<i>tJA</i>): IGBT alarm <i>ULA</i> [Underload. Proc. Al.] (<i>ULA</i>): Underload alarm <i>OLA</i> [Overload. Proc. Al.] (<i>OLA</i>): Overload alarm <i>r5dA</i> [Rope slack alarm] (<i>r5dA</i>): Rope slack (see [Rope slack config.] (r5d) parameter page 190) <i>t t HA</i> [High torque alarm] (<i>t t HA</i>): Motor torque overshooting high threshold [High torque thd.] (t t H) page 89 . <i>t t LA</i> [Low torque alarm] (<i>t t LA</i>): Motor torque undershooting low threshold [Low torque thd.] (t t L) page 89 . <i>F9LA</i> [Freq. meter Alarm] (<i>F9LA</i>): Measured speed threshold attained: [Pulse warning thd.] (F9L) page 89 . <i>dLdA</i> [Dynamic load alarm] (<i>dLdA</i>): Load variation detection (see [DYNAMIC LOAD DETECT.] (dLd -) page 248). See the multiple selection procedure on page 33 for the integrated display terminal, and page 24 for the graphic display terminal. |
| A2C - | [ALARM GRP2 DEFINITION] |
| | Identical to [ALARM GRP1 DEFINITION] (A1C -) page 130 . |
| A3C - | [ALARM GRP3 DEFINITION] |
| | Identical to [ALARM GRP1 DEFINITION] (A1C -) page 130 . |

Command

The parameters in the **[COMMAND]** (C E L -) menu can only be modified when the drive is stopped and no run command is present.

Command and reference channels

Run commands (forward, reverse, stop, etc.) and references can be sent using the following channels:

| Command | Reference |
|---|--|
| Terminals: logic inputs LI or analog inputs used as logic inputs LA | Terminals: analog inputs AI, pulse input |
| Function blocks | Function blocks |
| Remote display terminal | Remote display terminal |
| Graphic display terminal | Graphic display terminal |
| Integrated Modbus | Integrated Modbus |
| Integrated CANopen® | Integrated CANopen® |
| Communication card | Communication card |
| | +/- speed via the terminals |
| | +/- speed via the graphic display terminal |

⚠ DANGER

UNINTENDED EQUIPMENT OPERATION

When analog inputs **[AI1]** (R I 1) or **[AI2]** (R I 2) are used as logic inputs (**[LA1]** (L R I 1) or **[LA2]** (L R I 2)) in a configuration, they remain active in their behaviors in analog input mode (example : **[Ref.1 channel]** (F r 1) is still set to **[AI1]** (R I 1)).

- Remove the configuration of **[AI1]** (R I 1) or **[AI2]** (R I 2) in analog input mode

or

- Check this behavior will not endanger personnel or equipment in any way

Failure to follow these instructions will result in death or serious injury.

Note: **[LA1]** (L R I 1) and **[LA2]** (L R I 2) can be used as 2 logic inputs in source mode only.

- + 24 V power supply (max. 30 V)
- State 0 if < 7.5 V, state 1 if > 8.5 V.

Note: The stop keys on the graphic display terminal or remote display can be programmed as non-priority keys. A stop key can only have priority if the **[Stop Key priority]** (P 5 E) parameter in the **[COMMAND]** (C E L -) menu, page 139 is set to **[Yes]** (Y E S).

The behavior of the Altivar 32 can be adapted according to requirements:

- **[Not separ.]** (S I N): Command and reference are sent via the same channel.
- **[Separate]** (S E P): Command and reference may be sent via different channels.

In these configurations, control via the communication bus is performed in accordance with the DRIVECOM standard with only 5 freely-assignable bits (see Communication Parameters Manual). The application functions cannot be accessed via the communication interface.

- **[I/O profile]** (I O): The command and the reference can come from different channels. This configuration both simplifies and extends use via the communication interface. Commands may be sent via the logic inputs on the terminals or via the communication bus. When commands are sent via a bus, they are available on a word, which acts as virtual terminals containing only logic inputs. Application functions can be assigned to the bits in this word. More than one function can be assigned to the same bit.

Note: Stop commands from the graphic display terminal or remote display terminal remain active even if the terminals are not the active command channel.

Reference channel for [Not separ.] (5 IN), [Separate] (5 EP) and [I/O profile] (ID) configurations, PID not configured

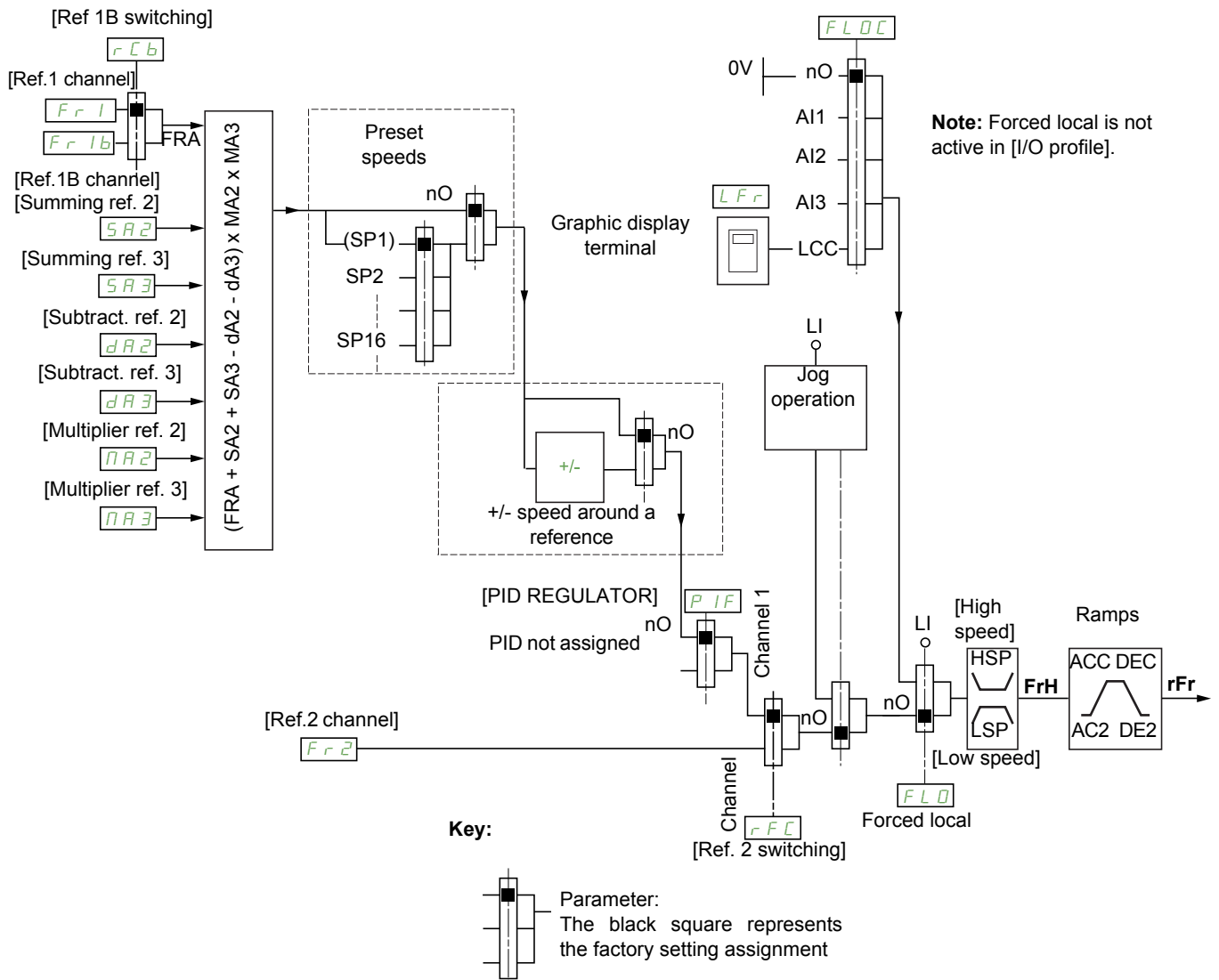

Fr 1, SA2, SA3, dA2, dA3, PA2, PA3:

- Terminals, graphic display terminal, integrated Modbus, integrated CANopen®, communication card

Fr 1b, for 5 EP and ID:

- Terminals, graphic display terminal, integrated Modbus, integrated CANopen®, communication card

Fr 1b, for 5 IN:

- Terminals, only accessible if Fr 1 = terminals

Fr 2:

- Terminals, graphic display terminal, integrated Modbus, integrated CANopen®, communication card, and +/- speed

Note: [Ref.1B channel] (Fr 1b) and [Ref 1B switching] (rCb) must be configured in the [APPLICATION FUNCT.] (Fun-) menu.

Reference channel for [Not separ.] (5 IN), [Separate] (SEP) and [I/O profile] (IO) configurations, PID configured with PID references at the terminals

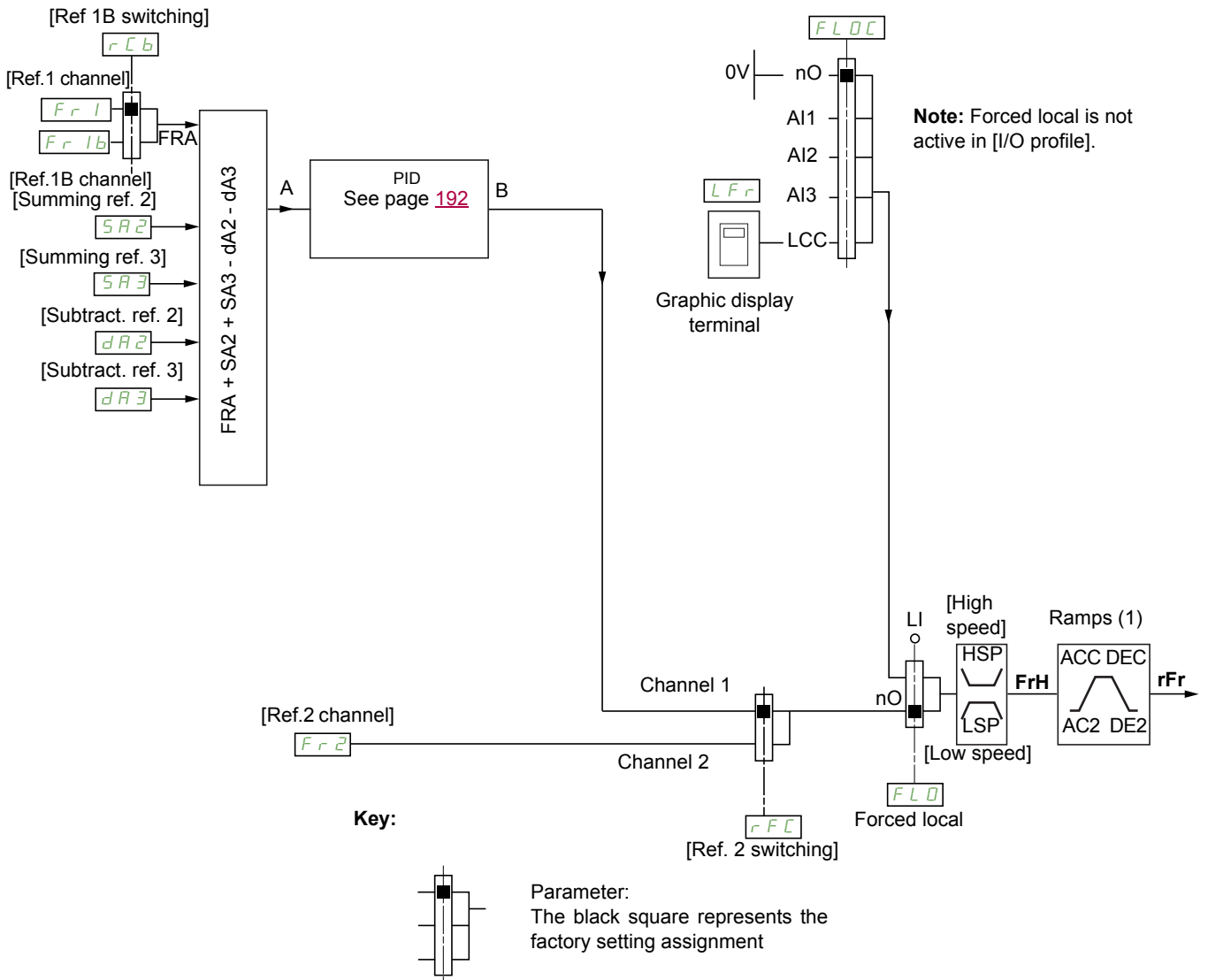

(1) Ramps not active if the PID function is active in automatic mode.

Fr 1:

- Terminals, graphic display terminal, integrated Modbus, integrated CANopen®, communication card

Fr 1b, for SEP and IO:

- Terminals, graphic display terminal, integrated Modbus, integrated CANopen®, communication card

Fr 1b, for 5 IN:

- Terminals, only accessible if Fr 1 = terminals

SA2, SA3, dA2, dA3:

- Terminals only

Fr 2:

- Terminals, graphic display terminal, integrated Modbus, integrated CANopen®, communication card, **and +/- speed**

Note: [Ref.1B channel] (Fr 1b) and [Ref 1B switching] (rCb) must be configured in the [APPLICATION FUNCT.] (Fun-) menu.

Command channel for [Not separ.] (5 I 0) configuration

Reference and command, not separate

The command channel is determined by the reference channel. Parameters *F r 1*, *F r 2*, *r F C*, *F L D* and *F L D C* are common to reference and command.

Example: If the reference is *F r 1 = A I 1* (analog input at the terminals), control is via *L I* (logic input at the terminals).

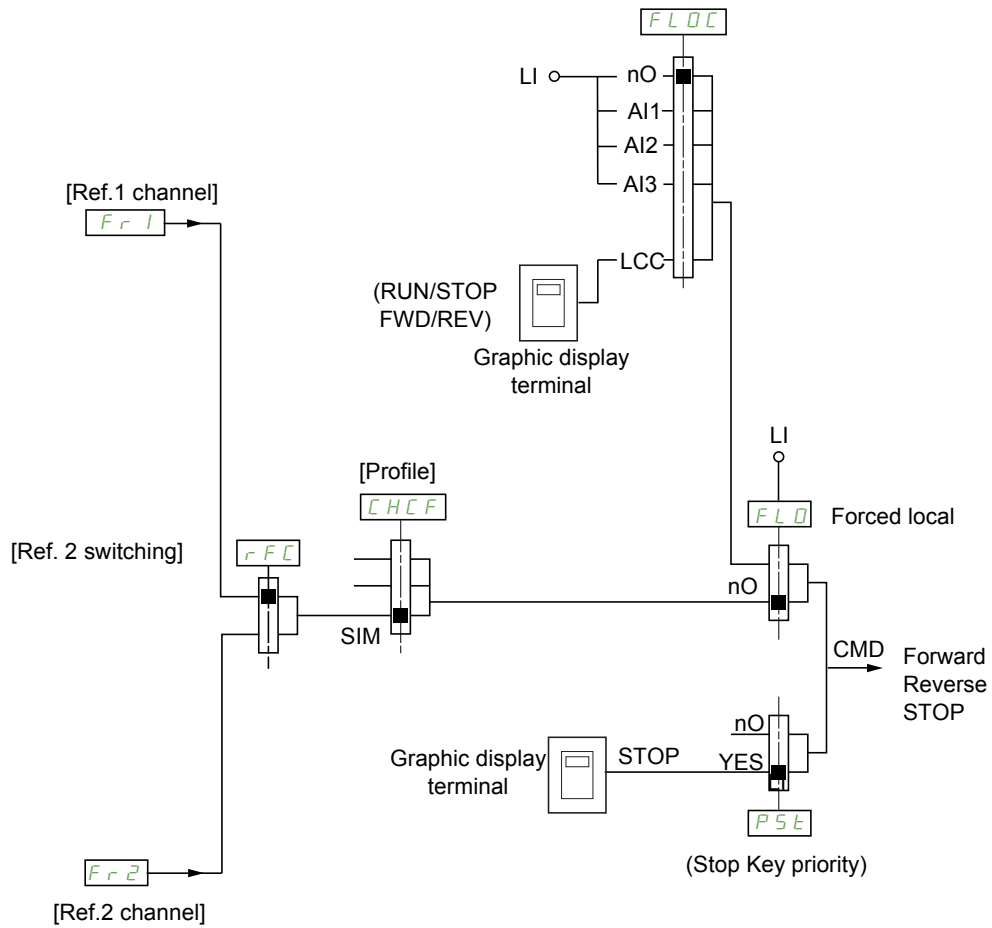

Key:

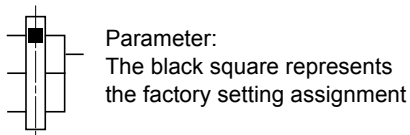

Command channel for [Separate] (SEP) configuration

Separate reference and command

Parameters *FLO* and *FLOC* are common to reference and command.

Example: If the reference is in forced local mode via *RII* (analog input at the terminals), command in forced local mode is via *LI* (logic input at the terminals).

The command channels *Cd1* and *Cd2* are independent of the reference channels *Fri*, *FriB* and *Fri2*.

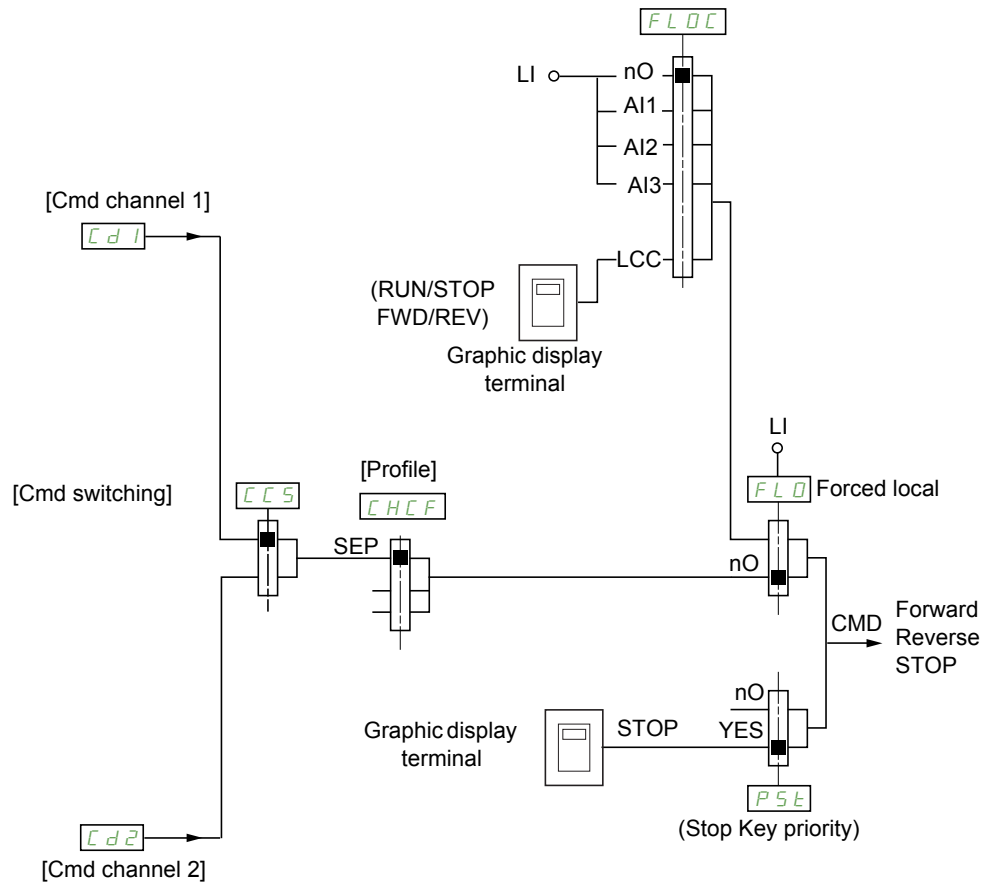

Key:

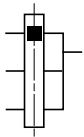

Parameter:
The black square represents the factory setting assignment, except for [Profile].

***Cd1*, *Cd2*:**

- Terminals, graphic display terminal, integrated Modbus, integrated CANopen®, communication card

Command channel for [I/O profile] (ID) configuration

Separate reference and command, as in [Separate] (SEP) configuration

The command channels $Cd1$ and $Cd2$ are independent of the reference channels $Fr1$, $Fr1b$ and $Fr2$.

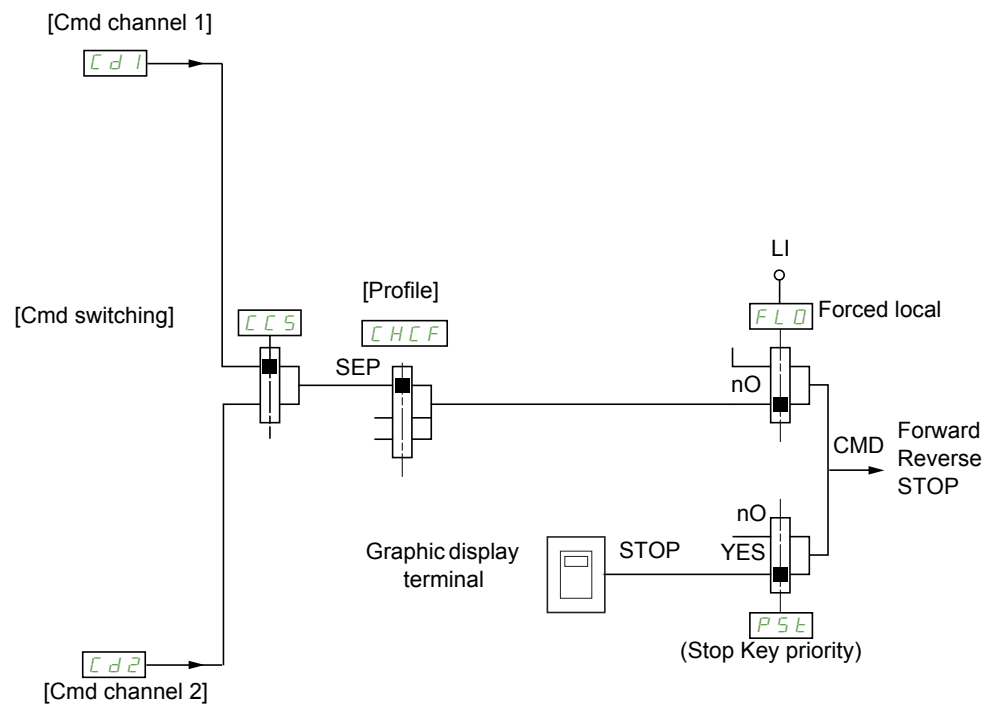

Key:

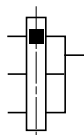

Parameter:
The black square represents the factory setting assignment, except for [Profile].

$Cd1$, $Cd2$:

- Terminals, graphic display terminal, integrated Modbus, integrated CANopen®, communication card

A command or an action can be assigned:

- To a fixed channel by selecting an LI input or a Cxxx bit:
 - By selecting, for example, $L13$, this action will be triggered by $L13$ regardless of which command channel is switched.
 - By selecting, for example, $C214$, this action will be triggered by integrated CANopen® with bit 14 regardless of which command channel is switched.
- To a switchable channel by selecting a CDxx bit:
 - By selecting, for example, $CD11$, this action will be triggered by:
 - $L112$ if the terminals channel is active
 - $C111$ if the integrated Modbus channel is active
 - $C211$ if the integrated CANopen® channel is active
 - $C311$ if the communication card channel is active

If the active channel is the graphic display terminal, the functions and commands assigned to CDxx switchable internal bits are inactive.

Note: $CD06$ to $CD13$ can only be used for switching between 2 networks. They do not have equivalent logic inputs.

| Terminals | Integrated Modbus | Integrated CANopen® | Communication card | Internal bit, can be switched |
|--------------|-------------------|---------------------|--------------------|-------------------------------|
| | | | | CD00 |
| LI2 (1) | C101 (1) | C201 (1) | C301 (1) | CD01 |
| LI3 | C102 | C202 | C302 | CD02 |
| LI4 | C103 | C203 | C303 | CD03 |
| LI5 | C104 | C204 | C304 | CD04 |
| LI6 | C105 | C205 | C305 | CD05 |
| - | C106 | C206 | C306 | CD06 |
| - | C107 | C207 | C307 | CD07 |
| - | C108 | C208 | C308 | CD08 |
| - | C109 | C209 | C309 | CD09 |
| - | C110 | C210 | C310 | CD10 |
| - | C111 | C211 | C311 | CD11 |
| - | C112 | C212 | C312 | CD12 |
| LAI1 | C113 | C213 | C313 | CD13 |
| LAI2 | C114 | C214 | C314 | CD14 |
| - | C115 | C215 | C315 | CD15 |
| OL01 to OL10 | | | | |

(1) If [2/3 wire control] (E C C) page 73 is set to [3 wire] (E C), L 12, C 10 I, C 20 I and C 30 I cannot be accessed.

Assignment conditions for logic inputs and control bits

The following elements are available for every command or function that can be assigned to a logic input or a control bit:

| | |
|--------------------------------------|--|
| [L11] (L 1 1) to [L16] (L 1 6) | Drive with or without option |
| [LAI1] (L R 1 1) to [LAI2] (L R 1 2) | Logical inputs |
| [C101] (C 1 0 1) to [C110] (C 1 1 0) | With integrated Modbus in [I/O profile] (I 0) configuration |
| [C111] (C 1 1 1) to [C115] (C 1 1 5) | With integrated Modbus regardless of configuration |
| [C201] (C 2 0 1) to [C210] (C 2 1 0) | With integrated CANopen® in [I/O profile] (I 0) configuration |
| [C211] (C 2 1 1) to [C215] (C 2 1 5) | With integrated CANopen® regardless of configuration |
| [C301] (C 3 0 1) to [C310] (C 3 1 0) | With a communication card in [I/O profile] (I 0) configuration |
| [C311] (C 3 1 1) to [C315] (C 3 1 5) | With a communication card regardless of configuration |
| [CD00] (C d 0 0) to [CD10] (C d 1 0) | In [I/O profile] (I 0) configuration |
| [CD11] (C d 1 1) to [CD15] (C d 1 5) | Regardless of configuration |
| [OL01] (O L 0 1) to [OL10] (O L 1 0) | Regardless of configuration |

Note: In [I/O profile] (I 0) configuration, L 1 1 cannot be accessed and if [2/3 wire control] (E C C) page 73 is set to [3 wire] (3 C), L 1 2, C 1 0 1, C 2 0 1 and C 3 0 1 cannot be accessed either.



▲ WARNING

LOSS OF CONTROL

Inactive communication channels are not monitored (no trip in the event of a communication bus interruption).

Check that the commands and functions assigned to bits C101 to C315 will not pose a risk in the event of the interruption of the associated communication bus.

Failure to follow these instructions can result in death, serious injury, or equipment damage.

| Code | Name / Description | Adjustment range | Factory setting |
|---|--|------------------|-----------------------------|
| FULL | [FULL] (continued) | | |
| CEL - | [COMMAND] | | |
| Fr I | [Ref.1 channel] | | [AI1] (R I I) |
| A I 1 | [AI1] (R I I): Analog input A1 | | |
| A I 2 | [AI2] (R I 2): Analog input A2 | | |
| A I 3 | [AI3] (R I 3): Analog input A3 | | |
| L C C | [HMI] (L C C): Graphic display terminal or remote display terminal source | | |
| Mod b | [Modbus] (Mod b): Integrated Modbus | | |
| CAN | [CANopen] (CAN): Integrated CANopen® | | |
| net | [Com. card] (net): Communication card (if inserted) | | |
| P I | [RP] (P I): Pulse input | | |
| A I U 1 | [AI virtual 1] (A I U 1): Virtual analog input 1 with the jog dial (only available if [Profile] (C H C F) is not set to [Not separ.] (S I N)) | | |
| OA 0 1 | [OA01] (OA 0 1): Function blocks: Analog Output 01 | | |
| ... | ... | | |
| OA 1 0 | [OA10] (OA 1 0): Function blocks: Analog Output 10 | | |
| r In | [RV Inhibition] | | [No] (n D) |
| | Inhibition of movement in reverse direction, does not apply to direction requests sent by logic inputs. Reverse direction requests sent by logic inputs are taken into account. Reverse direction requests sent by the graphic display terminal are not taken into account. Reverse direction requests sent by the line are not taken into account. Any reverse speed reference originating from the PID, summing input, etc., is interpreted as a zero reference (0 Hz). | | |
| n D | [No] (n D) | | |
| Y E S | [Yes] (Y E S) | | |
| P S E | [Stop Key priority] | | [Yes] (Y E S) |
|  2 s | <div style="border: 1px solid black; padding: 10px;"> <p style="text-align: center;">⚠ WARNING</p> <p>LOSS OF CONTROL</p> <p>You are going to disable the stop key located on the remote displays. Do not select [No] (n D) unless exterior stopping methods exist.</p> <p>Failure to follow these instructions can result in death, serious injury, or equipment damage.</p> </div> | | |
| | This will be a freewheel stop. If the active command channel is the graphic display terminal, the stop will be performed according to the [Type of stop] (S E E) page 158 irrespective of the configuration of [Stop Key priority] (P S E) . | | |
| n D | [No] (n D) | | |
| Y E S | [Yes] (Y E S): Gives priority to the STOP key on the graphic display terminal when the graphic display terminal is not enabled as the command channel. | | |
| C H C F | [Profile] | | [Not separ.] (S I N) |
|  2 s | <div style="background-color: black; color: white; padding: 5px; text-align: center;">⚠ DANGER</div> <div style="border: 1px solid black; padding: 10px;"> <p>UNINTENDED EQUIPMENT OPERATION</p> <p>When [I/O profile] (I D) is deselected, the drive automatically returns to the factory setting. Check that the modification of the current configuration is compatible with the wiring diagram used.</p> <p>Failure to follow these instructions will result in death or serious injury.</p> </div> | | |
| S I N | [Not separ.] (S I N): Reference and command, not separate | | |
| S E P | [Separate] (S E P): Separate reference and command. This assignment cannot be accessed in [I/O profile] (I D) . | | |
| I D | [I/O profile] (I D): I/O profile | | |

Parameters described in this page can be accessed by:

DRI -> CONF > FULL > CTL-

| Code | Name / Description | Adjustment range | Factory setting |
|--|--|------------------|-------------------------|
| C C 5 ★ C d 1 C d 2 L I 1 ... | [Cmd switching] This parameter can be accessed if [Profile] (C H C F) is set to [Separate] (S E P) or [I/O profile] (I O). If the assigned input or bit is at 0, channel [Cmd channel 1] (C d 1) is active. If the assigned input or bit is at 1, channel [Cmd channel 2] (C d 2) is active. [ch1 active] (C d 1): [Cmd channel 1] (C d 1) active (no switching) [ch2 active] (C d 2): [Cmd channel 2] (C d 2) active (no switching) [LI1] (L I 1): Logical input LI1 [...] (. . .): See the assignment conditions on page 138 (not C d 0 0 to C d 1 5) | | [ch1 active] (C d 1) |
| C d 1 ★ t E r L C C M d b C A n n E t | [Cmd channel 1] This parameter can be accessed if [Profile] (C H C F) is set to [Separate] (S E P) or [I/O profile] (I O). [Terminals] (t E r): Terminals [HMI] (L C C): Graphic display terminal or remote display terminal [Modbus] (M d b): Integrated Modbus [CANopen] (C A n): Integrated CANopen® [Com. card] (n E t): Communication card (if inserted) | | [Terminals] (t E r) |
| C d 2 ★ t E r L C C M d b C A n n E t | [Cmd channel 2] This parameter can be accessed if [Profile] (C H C F) is set to [Separate] (S E P) or [I/O profile] (I O). [Terminals] (t E r): Terminals [HMI] (L C C): Graphic display terminal or remote display terminal [Modbus] (M d b): Integrated Modbus [CANopen] (C A n): Integrated CANopen® [Com. card] (n E t): Communication card (if inserted) | | [Modbus] (M d b) |
| r F C F r 1 F r 2 L I 1 ... | [Ref. 2 switching] This parameter can be accessed if [Profile] (C H C F) is set to [Separate] (S E P) or [I/O profile] (I O). If the assigned input or bit is at 0, channel [Cmd channel 1] (C d 1) is active. If the assigned input or bit is at 1, channel [Cmd channel 2] (C d 2) is active. [Ref. 1 channel] (F r 1): [Cmd channel 1] (C d 1) active (no switching) [Ref. 2 channel] (F r 2): [Cmd channel 2] (C d 2) active (no switching) [LI1] (L I 1): Logical input LI1 [...] (. . .): See the assignment conditions on page 138 (not C d 0 0 to C d 1 5) | | [Ref.1 channel] (F r 1) |
| F r 2 n 0 A I 1 A I 2 A I 3 U P d t L C C M d b C A n n E t P I A I U I O A 0 I ... O A 1 0 | [Ref.2 channel] [No] (n 0): Not assigned. If [Profile] (C H C F) is set to [Not separ.] (S I N), the command is at the terminals with a zero reference. If [Profile] (C H C F) is set to [Separate] (S E P) or [I/O profile] (I O), the reference is zero. [AI1] (A I 1): Analog input A1 [AI2] (A I 2): Analog input A2 [AI3] (A I 3): Analog input A3 [+/-Speed] (U P d t): +/- speed command [HMI] (L C C): Graphic display terminal or remote display terminal [Modbus] (M d b): Integrated Modbus [CANopen] (C A n): Integrated CANopen® [Com. card] (n E t): Communication card (if inserted) [RP] (P I): Pulse input [AI virtual 1] (A I U I): Virtual analog input 1 with the jog dial [OA01] (O A 0 I): Function blocks: Analog Output 01 ... [OA10] (O A 1 0): Function blocks: Analog Output 10 | | [No] (n 0) |

| Code | Name / Description | Adjustment range | Factory setting |
|---|--|------------------|------------------|
| COP | [Copy channel 1 <> 2] | | [No] (nD) |
|  2 s | <div style="background-color: black; color: white; text-align: center; padding: 5px;">⚠ DANGER</div> <div style="border: 1px solid black; padding: 5px;"> <p>UNINTENDED EQUIPMENT OPERATION</p> <p>Copying the command and/or reference can change the direction of rotation. Check that this is safe.</p> <p>Failure to follow these instructions will result in death or serious injury.</p> </div> <p>Can be used to copy the current reference and/or the command by means of switching, in order to avoid speed surges, for example.</p> <p>If [Profile] (CHCF) page 139 is set to [Not separ.] (SIN) or [Separate] (SEP), copying will only be possible from channel 1 to channel 2.</p> <p>If [Profile] (CHCF) is set to [I/O profile] (IOD), copying will be possible in both directions.</p> <p>A reference or a command cannot be copied to a channel on the terminals.</p> <p>The reference copied is [Frequency ref.] (FRH) (before ramp) unless the destination channel reference is set via +/- speed. In this case, the reference copied is [Output frequency] (RFR) (after ramp).</p> <p>nD [No] (nD): No copy SP [Reference] (SP): Copy reference Cd [Command] (Cd): Copy command ALL [Cmd + ref.] (ALL): Copy command and reference</p> | | |



These parameters only appear if the corresponding function has been selected in another menu. When the parameters can also be accessed and adjusted from within the configuration menu for the corresponding function, their description is detailed in these menus, on the pages indicated, to aid programming.



To change the assignment of this parameter, press the ENT key for 2 s.

Parameters described in this page can be accessed by:

DRI- > CONF > FULL > CTL-

As the graphic display terminal may be selected as the command and/or reference channel, its action modes can be configured.

The parameters on this page can only be accessed on the graphic display terminal, and not on the integrated display terminal.

Comments:

- The display terminal command/reference is only active if the command and/or reference channels from the terminal are active with the exception of **[T/K] (F E)** (command via the display terminal), which takes priority over these channels. Press **[T/K] (F E)** (command via the display terminal) again to revert control to the selected channel.
- Command and reference via the display terminal are impossible if the latter is connected to more than one drive.
- The JOG, preset speed and +/- speed functions can only be accessed if **[Profile] (C H C F)** is set to **[Not separ.] (S I N)**.
- The preset PID reference functions can only be accessed if **[Profile] (C H C F)** is set to **[Not separ.] (S I N)** or **[Separate] (S E P)**.
- The **[T/K] (F E)** (command via the display terminal) can be accessed regardless of the **[Profile] (C H C F)**.

| Code | Name / Description | Adjustment range | Factory setting |
|----------------|---|------------------|-------------------------|
| F n 1 | [F1 key assignment] | | [No] (n 0) |
| n 0 | [No] (n 0) : Not assigned | | |
| F J O G | [Jog] (F J O G) : JOG operation | | |
| F P S 1 | [Preset spd2] (F P S 1) : Press the key to run the drive at the 2nd preset speed [Preset speed 2] (S P 2) page 84. Press STOP to stop the drive. | | |
| F P S 2 | [Preset spd3] (F P S 2) : Press the key to run the drive at the 3rd preset speed [Preset speed 3] (S P 3) page 84. Press STOP to stop the drive. | | |
| F P r 1 | [PID ref. 2] (F P r 1) : Sets a PID reference equal to the 2nd preset PID reference [Preset ref. PID 2] (r P 2) page 86, without sending a run command. Only operates if [Ref.1 channel] (F r 1) is set to [HMI] (L C C) . Does not operate with the [T/K] (F E) function. | | |
| F P r 2 | [PID ref. 3] (F P r 2) : Sets a PID reference equal to the 3rd preset PID reference [Preset ref. PID 3] (r P 3) page 87, without sending a run command. Only operates if [Ref.1 channel] (F r 1) is set to [HMI] (L C C) . Does not operate with the [T/K] (F E) function. | | |
| F u S P | [+speed] (F U S P) : Faster, only operates if [Ref.2 channel] (F r 2) is set to [HMI] (L C C) . Press the key to run the drive and increase the speed. Press STOP to stop the drive. | | |
| F d S P | [- speed] (F d S P) : Slower, only operates if [Ref.2 channel] (F r 2) is set to [HMI] (L C C) and if a different key has been assigned to [+ speed] . Press the key to run the drive and decrease the speed. Press STOP to stop the drive. | | |
| F E | [T/K] (F E) : Command via the display terminal: Takes priority over [Cmd switching] (C C 5) and over [Ref. 2 switching] (r F C) . | | |
| F n 2 | [F2 key assignment] | | [No] (n 0) |
| | Identical to [F1 key assignment] (F n 1) page 142. | | |
| F n 3 | [F3 key assignment] | | [No] (n 0) |
| | Identical to [F1 key assignment] (F n 1) page 142. | | |
| F n 4 | [F4 key assignment] | | [No] (n 0) |
| | Identical to [F1 key assignment] (F n 1) page 142. | | |
| b n P | [HMI cmd.] | | [Stop] (S E O P) |
| ★ | When the [T/K] (F E) function is assigned to a key and that function is active, this parameter defines the behavior at the moment when control returns to the graphic display terminal or remote display terminal. | | |
| S E O P | [Stop] (S E O P) : Stops the drive (although the controlled direction of operation and reference of the previous channel are copied (to be taken into account on the next RUN command)). | | |
| b u n P | [Bumpless] (b u n P) : Does not stop the drive (the controlled direction of operation and the reference of the previous channel are copied) | | |



These parameters only appear if the corresponding function has been selected in another menu. When the parameters can also be accessed and adjusted from within the configuration menu for the corresponding function, their description is detailed in these menus, on the pages indicated, to aid programming.

Function Block Management

| Code | Name / Description | Adjustment range | Factory setting |
|--------------------|--|------------------|-----------------|
| <i>FULL</i> | [FULL] (continued) | | |
| <i>FbΠ-</i> | [FUNCTION BLOCKS] | | |
| <i>ΠFb-</i> | [MONIT. FUN. BLOCKS] Note: This section shows only what is possible to do with local or remote display on the drive. For advanced configuration using PC software, please refer to the dedicated Function blocks manual. | | |
| <i>FbSt</i> | [FB Status] <i>Idle</i> [Idle] (Idle) : No binary file in the target, the FB is waiting for a download <i>ChEC</i> [Check] (ChEC) : Check the program downloaded <i>StOP</i> [Stop] (StOP) : The Function blocks application is stopped <i>Init</i> [Init] (Init) : Check coherency between ATVLogic program and Function blocks parameters <i>Run</i> [Run] (Run) : The Function blocks application is running <i>Err</i> [Error] (Err) : An internal error has been detected. The Function blocks application is in fault state mode. | | |
| <i>FbFt</i> | [FB Fault] <i>nD</i> [No] (nD) : No detected fault <i>Int</i> [Internal] (Int) : Internal detected error <i>Bin</i> [Binary file] (Bin) : Binary file corrupted <i>InP</i> [Intern Para.] (InP) : Internal parameter detected error <i>PAR</i> [Para. RW] (PAR) : Parameter access detected error <i>CAL</i> [Calculation] (CAL) : Calculation detected error <i>TOAU</i> [TO AUX] (TOAU) : TimeOut AUX task <i>TOsynch</i> [TO synch] (TOsynch) : TimeOut in PRE/POST task <i>ADL</i> [Bad ADLC] (ADL) : ADLC with bad parameter <i>In</i> [Input assig.] (In) : Input not configured | | |
| <i>FbI-</i> | [FB IDENTIFICATION] | | |
| <i>bUer</i> ★ | [Cust. program version] Program user version. | 0 to 255 | - |
| <i>bnS</i> ★ | [Program size] Program file size. | 0 to 65,535 | - |
| <i>bnU</i> | [Prg. format version] Binary format version of the drive. | 0 to 255 | - |
| <i>CtU</i> | [Catalog version] Catalog version of the drive. | 0 to 65,535 | - |
| <i>FbΠ-</i> | [FUNCTION BLOCKS] (continued) | | |
| <i>FbCd</i> () | [FB Command] Allows to start and stop the function blocks manually. [FB Command] (FbCd) is forced to [Stop] (StOP) if there is no valid function blocks application in the drive memory. [FB Command] (FbCd) is set to [Start] (StRt) when the function blocks application switch to Run according to [FB start mode] (FbrΠ) configuration. Note: As soon as the function blocks are started, the drive is considered as in running state and the modification of configuration parameters is no longer possible. <i>StOP</i> [Stop] (StOP) : Function blocks application Stop command <i>StRt</i> [Start] (StRt) : Function blocks application Start command | | |

Parameters described in this page can be accessed by:









DRI- > CONF > FULL > FBM-

| Code | Name / Description | Adjustment range | Factory setting |
|---|---|------------------|----------------------------|
| <i>F b r Π</i> | [FB start mode] | | [No] (n 0) |
|  2 s | <div style="background-color: black; color: white; padding: 5px; font-weight: bold; font-size: 1.2em;">⚠ DANGER</div> <div style="border: 1px solid black; padding: 5px; margin-top: 5px;"> <p>UNINTENDED EQUIPMENT OPERATION</p> <p>Start mode value will allow the start of the program by the selected channel. Check that this configuration will not endanger personnel or equipment in any way. Failure to follow these instructions will result in death or serious injury.</p> </div> | | |
| | <p>Allows to choose the different ways of starting the Function blocks application. Note: Modifications of this parameter are not taken into account if the Function blocks application is running.</p> <p><i>n 0</i> [No] (n 0): Function blocks application is controlled by [FB command] (F b C d) parameter <i>Y E 5</i> [Yes] (Y E 5): Function blocks application switches to Run automatically at drive power on <i>L I 1</i> [LI1] (L I 1): Function blocks application switches to Run on a rising edge of the logic input. It switch to Stop on falling edge of the logic input. <i>...</i> [...] (. . .): See the assignment conditions on page 138 (not [OL10] (O L 0 I) to [OL10] (O L 1 0)).</p> | | |
| <i>F b 5 Π</i> | [FB Stop mode] | | [Freewheel] (Y E 5) |
| | <div style="border: 1px solid black; padding: 5px; margin-bottom: 5px;"> <p style="font-weight: bold; font-size: 1.2em;">⚠ WARNING</p> </div> <div style="border: 1px solid black; padding: 5px;"> <p>LOSS OF CONTROL</p> <p>If [FB stop mode] (F b 5 Π) is set to [No] (n 0) the motor will not stop when the program will be stopped. Do not select these values unless exterior stopping methods exist. Failure to follow these instructions can result in death, serious injury, or equipment damage.</p> </div> | | |
| | <p>Allows to setup the way of working of the drive when function blocks are stopped.</p> <p><i>n 0</i> [Ignore] (n 0): The drive ignores the detected fault <i>Y E 5</i> [Freewheel] (Y E 5): Motor stops in freewheel <i>r Π P</i> [Ramp stop] (r Π P): Ramp stop <i>F 5 E</i> [Fast stop] (F 5 E): Fast stop <i>d C I</i> [DC injection] (d C I): DC injection</p> | | |
| <i>F b d F</i> | [FB on drive fault] | | [Stop] (5 E 0 P) |
| | <p>Behavior of function blocks when the drive trips.</p> <p><i>5 E 0 P</i> [Stop] (5 E 0 P): Function blocks stops when the drive trips, outputs are released <i>I G n</i> [Ignore] (I G n): Function blocks continue to work when the drive trips (except CFF and INFE)</p> | | |
| <i>F b A -</i> | [INPUTS ASSIGNMENTS] | | |
| <i>I L 0 I</i> | [Logic input 1 assignment] | | [No] (n 0) |
| | <p>Possible assignment for the Function block logic input.</p> <p><i>n 0</i> [No] (n 0): Not assigned <i>F L E</i> [No drive flt] (F L E): Drive fault detection status (relay normally energized, and de-energized if there is a trip) <i>F E A</i> [Freq. Th. attain.] (F E A): Frequency threshold attained ([Freq. threshold] (F E d) page 89) <i>F 2 A</i> [Freq. Th 2 attain.] (F 2 A): Frequency threshold 2 attained ([Freq. threshold 2] (F 2 d) page 89) <i>F r 1</i> [Ref.1 channel] (F r 1) Reference source 1 <i>F r 2</i> [Ref.2 channel] (F r 2) Reference source 2 <i>C d 1</i> [ch1 active] (C d 1): Command channel = channel 1 (for CSS) <i>C d 2</i> [ch2 active] (C d 2): Command channel = channel 2 (for CSS) <i>F r 1 b</i> [Ref.1B channel] (F r 1 b): Reference channel = channel 1b (for RFC) <i>Y E 5</i> [Yes] (Y E 5): Yes <i>L I 1</i> [LI1] (L I 1): Logical input LI1 <i>...</i> [...] (. . .): See the assignment conditions on page 138</p> | | |
| <i>I L - -</i> | [Logic input x assignment] | | [No] (n 0) |
| | <p>All the Function Blocks logic inputs available on the drive are processed as in the example for [Logic input 1 assignment] (I L 0 I) above, up to [Logic input 10 assignment] (I L 1 0).</p> | | |

| Code | Name / Description | Adjustment range | Factory setting |
|-------------|--|------------------|------------------|
| IA01 | [Analog input 1 assignment] Possible assignment for the Function block analog input. | | [No] (n0) |
| n0 | [No] (n0): Not assigned | | |
| A11 | [A11] (A11): Analog input A1 | | |
| A12 | [A12] (A12): Analog input A2 | | |
| A13 | [A13] (A13): Analog input A3 | | |
| DCr | [I motor] (DCr): Motor current | | |
| DFr | [Motor freq.] (DFr): Motor speed | | |
| DrP | [Ramp. out] (DrP): Ramp output | | |
| tr9 | [Motor torq.] (tr9): Motor torque | | |
| St9 | [Sign torque] (St9): Signed motor torque | | |
| DrS | [Sign ramp] (DrS): Signed ramp output | | |
| DP5 | [PID ref.] (DP5): PI(D) reference | | |
| DPF | [PID feedbk] (DPF): PI(D) feedback | | |
| DPE | [PID error] (DPE): PI(D) error | | |
| DP1 | [PID output] (DP1): PI(D) integral | | |
| DPp | [Mot. power] (DPp): Motor power | | |
| trHr | [Mot. thermal] (trHr): Motor thermal state | | |
| trHd | [Drv thermal] (trHd): Drive thermal state | | |
| tr9nS | [Torque 4Q] (tr9nS): Signed motor torque | | |
| UPdt | [+/-Speed] (UPdt): Up/Down function is assigned by Lix | | |
| UPdH | [+/-spd HMI] (UPdH): Up/Down function is assigned by graphic display terminal or remote display terminal | | |
| LCC | [HMI] (LCC): Graphic display terminal or remote display terminal source | | |
| ndb | [Modbus] (ndb): Integrated Modbus | | |
| CRn | [CANopen] (CRn): Integrated CANopen® | | |
| net | [Com. card] (net): Communication option board source | | |
| DF5 | [Sig. o/p frq.] (DF5): Signed output frequency | | |
| trHr2 | [Mot therm2] (trHr2): Motor 2 thermal state | | |
| trHr3 | [Mot therm3] (trHr3): Motor 3 thermal state | | |
| tr9L | [Torque lim.] (tr9L): Torque limitation | | |
| UOP | [Motor volt.] (UOP): Motor voltage | | |
| P1 | [RP] (P1): Pulse input | | |
| A1U1 | [AI virtual 1] (A1U1): Virtual analog input 1 with the jog dial | | |
| DO1 | [DO1] (DO1): Analog/logical output DO1 | | |
| A1U2 | [AI virtual 2] (A1U2): Virtual analog input 2 by the communication bus | | |
| OA01 | [OA01] (OA01): Function blocks: Analog Output 01 | | |
| ... | ... | | |
| OA10 | [OA10] (OA10): Function blocks: Analog Output 10 | | |
| IA-- | [Analog input x assignment] All the Function blocks analog inputs available on the drive are processed as in the example for [IA01] (IA01) above, up to [IA10] (IA10). | | [No] (n0) |
| FBn- | [FUNCTION BLOCKS] (continued) | | |
| FAd- | [ADL CONTAINERS] ADL containers contain Modbus logical address of internal parameters of the drive. If the chosen address is valid, the display shows the parameter name instead of the address. | | |
| LA01 | ADL Container 01 | 3,015 to 64,299 | 0 |
| LA02 | ADL Container 02 | 3,015 to 64,299 | 0 |
| LA03 | ADL Container 03 | 3,015 to 64,299 | 0 |
| LA04 | ADL Container 04 | 3,015 to 64,299 | 0 |
| LA05 | ADL Container 05 | 3,015 to 64,299 | 0 |
| LA06 | ADL Container 06 | 3,015 to 64,299 | 0 |
| LA07 | ADL Container 07 | 3,015 to 64,299 | 0 |
| LA08 | ADL Container 08 | 3,015 to 64,299 | 0 |

Parameters described in this page can be accessed by:

DRI- > CONF > FULL > FBM- > FBP-

| Code | Name / Description | Adjustment range | Factory setting |
|--|---|------------------|-----------------|
| F b P - | [FUNCTION BLOCKS] (continued) | | |
| F b P - | [FB PARAMETERS] Internal parameters available for the user program. | | |
| n 0 0 1 (1)  | [] M001 Parameter saved in EEPROM. | 0 to 65,535 | 0 |
| n 0 0 2 (1)  | [] M002 Parameter saved in EEPROM | 0 to 65,535 | 0 |
| n 0 0 3 (1)  | [] M003 Parameter saved in EEPROM | 0 to 65,535 | 0 |
| n 0 0 4 (1)  | [] M004 Parameter saved in EEPROM | 0 to 65,535 | 0 |
| n 0 0 5 (1)  | [] M005 Parameter written in RAM | 0 to 65,535 | 0 |
| n 0 0 6 (1)  | [] M006 Parameter written in RAM | 0 to 65,535 | 0 |
| n 0 0 7 (1)  | [] M007 Parameter written in RAM | 0 to 65,535 | 0 |
| n 0 0 8 (1)  | [] M008 Parameter written in RAM | 0 to 65,535 | 0 |

(1) If a graphic display terminal is not in use, values greater than 9,999 will be displayed on the 4-digit display with a period mark after the thousand digit, for example, 15.65 for 15,650.



These parameters only appear if the corresponding function has been selected in another menu. When the parameters can also be accessed and adjusted from within the configuration menu for the corresponding function, their description is detailed in these menus, on the pages indicated, to aid programming.

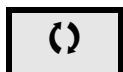

Parameter that can be modified during operation or when stopped.



To change the assignment of this parameter, press the ENT key for 2 s.

[APPLICATION FUNCT.] (F U n -)

Summary of functions:

| Code | Name | Page |
|-----------|--------------------------|---------------------|
| (r E F -) | [REFERENCE SWITCH.] | 152 |
| (D R I -) | [REF. OPERATIONS] | 153 |
| (r P t -) | [RAMP] | 155 |
| (S t t -) | [STOP CONFIGURATION] | 158 |
| (R d C -) | [AUTO DC INJECTION] | 161 |
| (J O G -) | [JOG] | 163 |
| (P S S -) | [PRESET SPEEDS] | 166 |
| (U P d) | [+/- SPEED] | 170 |
| (S r E -) | [+/-SPEED AROUND REF.] | 172 |
| (S P n -) | [MEMO REFERENCE] | 173 |
| (F L I -) | [FLUXING BY LI] | 174 |
| (b L C -) | [BRAKE LOGIC CONTROL] | 179 |
| (E L n -) | [EXTERNAL WEIGHT MEAS.] | 185 |
| (H S H -) | [HIGH SPEED HOISTING] | 190 |
| (P I d -) | [PID REGULATOR] | 196 |
| (P r I -) | [PID PRESET REFERENCES] | 200 |
| (t D L -) | [TORQUE LIMITATION] | 202 |
| (C L I -) | [2nd CURRENT LIMIT.] | 204 |
| (L L C -) | [LINE CONTACTOR COMMAND] | 206 |
| (O C C -) | [OUTPUT CONTACTOR CMD] | 208 |
| (L P D -) | [POSITIONING BY SENSORS] | 212 |
| (n L P -) | [PARAM. SET SWITCHING] | 215 |
| (n n C -) | [MULTIMOTORS/CONFIG.] | 220 |
| (t n L -) | [AUTO TUNING BY LI] | 221 |
| (t r D -) | [TRAVERSE CONTROL] | 222 |
| (C H S -) | [HSP SWITCHING] | 229 |

The parameters in the **[APPLICATION FUNCT.] (F U n -)** menu can only be modified when the drive is stopped and there is no run command, except for parameters with a  symbol in the code column, which can be modified with the drive running or stopped.

Note: Compatibility of functions

The choice of application functions may be limited by the number of I/O and by the fact that some functions are incompatible with others. Functions that are not listed in the table below are fully compatible.

If there is an incompatibility between functions, the first function configured will help to prevent the others being configured.

Each of the functions on the following pages can be assigned to one of the inputs or outputs.

⚠ DANGER**UNINTENDED EQUIPMENT OPERATION**

A single input can activate several functions at the same time (reverse and 2nd ramp for example).

Ensure that these functions can be used at the same time.

Failure to follow these instructions will result in death or serious injury.

It is only possible to assign one input to several functions at **[Advanced]** (*R d U*) and **[Expert]** (*E P r*) levels. Before assigning a command, reference or function to an input or output, the user must check that this input or output has not already been assigned and that another input or output has not been assigned to an incompatible function.

The drive factory setting or macro configurations automatically configure functions, **which may help to prevent other functions being assigned.**

In some case, it is necessary to unconfigure one or more functions in order to be able to enable another. Check the compatibility table below.

Stop functions have priority over run commands.

Speed references via logic command have priority over analog references.

Note: This compatibility table does not affect commands that can be assigned to the keys of the graphic display terminal (see page [24](#)).

Compatibility table

| | Reference operations (page 153) | +/- speed (3) (page 170) | Preset speeds (page 165) | PID regulator (page 196) | Traverse control (page 227) | JOG operation (page 163) | Reference switching (page 152) | Skip frequency (page 168) | Brake logic control (page 179) | Auto DC injection (page 161) | Catch on the fly (page 235) | Output contactor command (page 208) | DC injection stop (page 158) | Fast stop (page 158) | Freewheel stop (page 158) | +/- speed around a reference (page 172) | High speed hoisting (page 190) | Load sharing (page 109) | Positioning by sensors (page 212) |
|--|------------------------------------|-----------------------------|-----------------------------|-----------------------------|--------------------------------|-----------------------------|-----------------------------------|------------------------------|-----------------------------------|---------------------------------|--------------------------------|--|---------------------------------|-------------------------|------------------------------|--|-----------------------------------|----------------------------|--------------------------------------|
| Reference operations (page 153) | | | ↑ | ● (2) | | ↑ | ↑ | ↑ | | | | | | | | | | | |
| +/- speed (3) (page 170) | | | | | ● | ● | ↑ | ↑ | | | | | | | | | | | |
| Preset speeds (page 165) | ← | | | | | ↑ | ↑ | ↑ | | | | | | | | | | | |
| PID regulator (page 196) | ● (2) | | | | ● | ● | ↑ | ↑ | ● | | | | | | | ● | ● | ● | ● |
| Traverse control (page 227) | | ● | | ● | | ● | ↑ | ↑ | | | | | | | | ● | ● | | |
| JOG operation (page 163) | ← | ● | ← | ● | ● | | | ↑ | ● | ← | | | | | | ● | ● | | |
| Reference switching (page 152) | ← | ← | ← | ← | ← | | | ↑ | | | | | | | | ↑ | | | |
| Skip frequency (page 168) | ← | ← | ← | ← | ← | ← | ← | | | | | | | | | ← | | | |
| Brake logic control (page 179) | | | | ● | | ● | | | | | ● | ● | ● | | | | | | |
| Auto DC injection (page 161) | | | | | | ↑ | | | | | | | ↑ | | ↑ | | | | |
| Catch on the fly (page 235) | | | | | | | | | ● | | | | | | | | | | |
| Output contactor command (page 208) | | | | | | | | | ● | | | | | | | | | | |
| DC injection stop (page 158) | | | | | | | | | ● | ← | | | | ● (1) | ↑ | | | | |
| Fast stop (page 158) | | | | | | | | | | | | | ● (1) | | ↑ | | | | |
| Freewheel stop (page 158) | | | | | | | | | | ← | | | ← | ← | | | | | |
| +/- speed around a reference (page 172) | | | | ● | ● | ● | ← | ← | | | | | | | | | | | |
| High speed hoisting (page 190) | | | | ● | ● | ● | | | | | | | | | | | | | |
| Load sharing (page 109) | | | | ● | | | | | | | | | | | | | | | |
| Positioning by sensors (page 212) | | | | ● | | | | | | | | | | | | | | | |

(1) Priority is given to the first of these two stop modes to be activated.
 (2) Only the multiplier reference is incompatible with the PID regulator.

● Incompatible functions □ Compatible functions ■ Not applicable

Priority functions (functions which cannot be active at the same time):

← ↑ The function indicated by the arrow has priority over the other.

Incompatible Functions

The following function will be inaccessible or deactivated after an Automatic restart.

This is only possible for control type if **[2/3 wire control]** (**LC**) is set to **[2 wire]** (**2C**) and if **[2 wire type]** (**LC**) is set to **[Level]** (**LEL**) or **[Fwd priority]** (**PF**). See **[2/3 wire control]** (**LC**) page **73**.

The **[1.2 MONITORING]** (**MDn -**) menu page **41** can be used to display the functions assigned to each input in order to check their compatibility.

When a function is assigned, a ✓ appears on the graphic display terminal, as illustrated in the example below:

| | | | |
|--------------------|------|-------|-------|
| RDY | Term | 0.0Hz | 0A |
| APPLICATION FUNCT. | | | |
| REFERENCE SWITCH. | | | |
| REF. OPERATIONS | | | |
| RAMP | | | |
| STOP CONFIGURATION | | | |
| AUTO DC INJECTION | | | |
| Code | << | >> | Quick |

If you attempt to assign a function that is incompatible with another function that has already been assigned, an alarm message will appear:

- With the graphic display terminal:

| | | | |
|--|------|---------|-------|
| RDY | Term | +0.0 Hz | 0.0 A |
| INCOMPATIBILITY | | | |
| The function can't be assigned because an incompatible function is already selected. See programming book. | | | |
| ENT or ESC to continue | | | |

- With the integrated display terminal and the remote display terminal:
COMP flashes until ENT or ESC is pressed.

When you assign a logic input, an analog input, a reference channel or a bit to a function, pressing the HELP key will display the functions that may already have been activated by this input, bit or channel.

When a logic input, an analog input, a reference channel or a bit that has already been assigned is assigned to another function, the following screens appear:

- With the graphic display terminal:

| | | | |
|-----------------------|------|-----------|-------|
| RUN | Term | 0.0 Hz | 0.0 A |
| WARNING - ASSIGNED TO | | | |
| Forward | | | |
| ENT-Valid. | | ESC-Abort | |

If the access level permits this new assignment, pressing ENT confirms the assignment.

If the access level does not permit this new assignment, pressing ENT results in the following display:

| | | | |
|--|------|--------|-------|
| RUN | Term | 0.0 Hz | 0.0 A |
| ASSIGNMENT FORBIDDEN | | | |
| Un-assign the present functions, or select "Advanced" access level | | | |

- With the integrated display terminal:

The code for the first function, which is already assigned, is displayed flashing.

If the access level permits this new assignment, pressing ENT confirms the assignment.

If the access level does not permit this new assignment, pressing ENT has no effect, and the message continues to flash. It is only possible to exit by pressing ESC.

Parameters described in this page can be accessed by:

DRI- > CONF > FULL > REF-

REFERENCE SWITCHING

| Code | Name / Description | Adjustment range | Factory setting |
|----------------|--|------------------|-----------------------------|
| <i>F U n -</i> | [APPLICATION FUNCT.] | | |
| <i>r E F -</i> | [REFERENCE SWITCH.] | | |
| <i>r C b</i> | [Ref 1B switching] | | [ch1 active] (F r I) |
| | <p>See the diagrams on pages 132 and 133.</p> <p>If the assigned input or bit is at 0, [Ref.1 channel] (F r I) is active (see [Ref.1 channel] (F r I) page 139).</p> <p>If the assigned input or bit is at 1, [Ref.1B channel] (F r I b) is active.</p> <p>[Ref 1B switching] (r C b) is forced to [ch1 active] (F r I) if [Profile] (C H C F) is set to [Not separ.] (S I N) with [Ref.1 channel] (F r I) assigned via the terminals (analog inputs, pulse input). See [Ref.1 channel] (F r I) page 139.</p> | | |
| <i>F r I</i> | [ch1 active] (F r I) : No switching, [Ref.1 channel] (F r I) active | | |
| <i>F r I b</i> | [ch1B active] (F r I b) : No switching, [Ref.1B channel] (F r I b) active | | |
| <i>L I 1</i> | [LI1] (L I 1) : Logical input LI1 | | |
| <i>...</i> | [...] (. . .): See the assignment conditions on page 138 (not [Cd00] (C d 0 0) to [Cd15] (C d 1 5)). | | |
| <i>F r I b</i> | [Ref.1B channel] | | [No] (n 0) |
| <i>n 0</i> | [No] (n 0) : Not assigned | | |
| <i>A I 1</i> | [AI1] (A I 1) : Analog input A1 | | |
| <i>A I 2</i> | [AI2] (A I 2) : Analog input A2 | | |
| <i>A I 3</i> | [AI3] (A I 3) : Analog input A3 | | |
| <i>L C C</i> | [HMI] (L C C) : Graphic display terminal or remote display terminal source | | |
| <i>M d b</i> | [Modbus] (M d b) : Integrated Modbus | | |
| <i>C A n</i> | [CANopen] (C A n) : Integrated CANopen® | | |
| <i>n E t</i> | [Com. card] (n E t) : Communication option board source | | |
| <i>P I</i> | [RP] (P I) : Pulse input | | |
| <i>A I U I</i> | [AI virtual 1] (A I U I) : Virtual analog input 1 with the jog dial (only available if [Profile] (C H C F) is not set to [Not separ.] (S I N)) | | |
| <i>O A 0 1</i> | [OA01] (O A 0 1) : Function blocks: Analog Output 01 | | |
| <i>...</i> | ... | | |
| <i>O A 1 0</i> | [OA10] (O A 1 0) : Function blocks: Analog Output 10 | | |

REFERENCE OPERATIONS

Summing input / Subtracting input / Multiplier

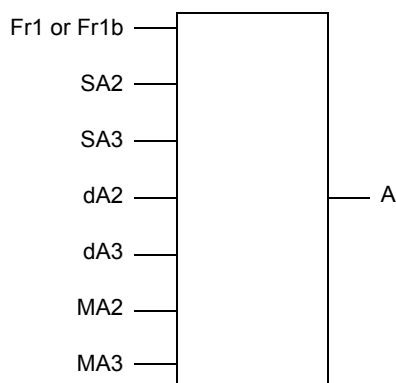

$$A = (Fr1 \text{ or } Fr1b + SA2 + SA3 - dA2 - dA3) \times MA2 \times MA3$$

- If *SAR2*, *SAR3*, *dAR2*, *dAR3* are not assigned, they are set to 0.
- If *MA2*, *MA3* are not assigned, they are set to 1.
- A is limited by the minimum *LSP* and maximum *HSP* parameters.
- For multiplication, the signal on *MA2* or *MA3* is interpreted as a %. 100% corresponds to the maximum value of the corresponding input. If *MA2* or *MA3* is sent via the communication bus or graphic display terminal, an *PFr* multiplication variable, page 266 must be sent via the bus or graphic display terminal.
- Reversal of the direction of operation in the event of a negative result can be inhibited (see [\[RV Inhibition\]](#) (*SIn*) page 139).

| Code | Name / Description | Adjustment range | Factory setting |
|-------------|--|------------------|---------------------------|
| <i>FUn-</i> | [APPLICATION FUNCT.] (continued) | | |
| <i>OAI-</i> | [REF. OPERATIONS] Reference = (Fr1 or Fr1b + SA2 + SA3 - dA2 - dA3) x MA2 x MA3. See the diagrams on pages 132 and 133. Note: This function cannot be used with certain other functions. Follow the instructions on page 148. | | |
| <i>SAR2</i> | [Summing ref. 2] Selection of a reference to be added to [Ref.1 channel] (<i>Frl</i>) or [Ref.1B channel] (<i>Frlb</i>). | | [No] (<i>n0</i>) |
| <i>n0</i> | [No] (<i>n0</i>): Not assigned | | |
| <i>A11</i> | [AI1] (<i>A11</i>): Analog input A1 | | |
| <i>A12</i> | [AI2] (<i>A12</i>): Analog input A2 | | |
| <i>A13</i> | [AI3] (<i>A13</i>): Analog input A3 | | |
| <i>LCC</i> | [HMI] (<i>LCC</i>): Graphic display terminal or remote display terminal source | | |
| <i>Modb</i> | [Modbus] (<i>Modb</i>): Integrated Modbus | | |
| <i>CRn</i> | [CANopen] (<i>CRn</i>): Integrated CANopen® | | |
| <i>NEE</i> | [Com. card] (<i>NEE</i>): Communication option board source | | |
| <i>PI</i> | [RP] (<i>PI</i>): Motor voltage | | |
| <i>A1U1</i> | [AI virtual 1] (<i>A1U1</i>): Virtual analog input 1 with the jog dial | | |
| <i>A1U2</i> | [AI virtual 2] (<i>A1U2</i>): Virtual analog input 2 by the communication bus | | |
| <i>OAO1</i> | [OA01] (<i>OAO1</i>): Function blocks: Analog Output 01 | | |
| ... | ... | | |
| <i>OAI0</i> | [OA10] (<i>OAI0</i>): Function blocks: Analog Output 10 | | |
| <i>SAR3</i> | [Summing ref. 3] Selection of a reference to be added to [Ref.1 channel] (<i>Frl</i>) or [Ref.1B channel] (<i>Frlb</i>). Identical to [Summing ref. 2] (<i>SAR2</i>) page 153. | | [No] (<i>n0</i>) |
| <i>dAR2</i> | [Subtract. ref. 2] Selection of a reference to be subtracted from [Ref.1 channel] (<i>Frl</i>) or [Ref.1B channel] (<i>Frlb</i>). Identical to [Summing ref. 2] (<i>SAR2</i>) page 153. | | [No] (<i>n0</i>) |

Parameters described in this page can be accessed by:

DRI- > CONF > FULL > FUN- > OAI-

| Code | Name / Description | Adjustment range | Factory setting |
|------|---|------------------|------------------|
| дРЭ | [Subtract. ref. 3] Selection of a reference to be subtracted from [Ref.1 channel] (Fr I) or [Ref.1B channel] (Fr Ib). Identical to [Summing ref. 2] (SR2) page 153. | | [No] (n0) |
| ПРЭ | [Multiplier ref. 2] Selection of a multiplier reference [Ref.1 channel] (Fr I) or [Ref.1B channel] (Fr Ib). Identical to [Summing ref. 2] (SR2) page 153. | | [No] (n0) |
| ПРЭ | [Multiplier ref. 3] Selection of a multiplier reference [Ref.1 channel] (Fr I) or [Ref.1B channel] (Fr Ib). Identical to [Summing ref. 2] (SR2) page 153. | | [No] (n0) |

RAMP

| Code | Name / Description | Adjustment range | Factory setting |
|----------------|---|---------------------|-------------------------|
| F U n - | [APPLICATION FUNCT.] (continued) | | |
| r P t - | [RAMP] | | |
| r P t | [Ramp type] | | [Linear] (L I n) |
| L I n | [Linear] (L I n) | | |
| S | [S ramp] (S) | | |
| U | [U ramp] (U) | | |
| C U S | [Customized] (C U S) | | |
| () | <p>S ramps</p> <p>The rounding coefficient is fixed, t1 = 0.6 set ramp time (linear) t2 = 0.4 set ramp time (round) t3 = 1.4 set ramp time</p> <p>U ramps</p> <p>The rounding coefficient is fixed, t1 = 0.5 set ramp time (linear) t2 = 1.0 set ramp time (round) t3 = 1.5 set ramp time</p> <p>Customized ramps</p> <p>tA1: adjustable from 0 to 100% tA2: adjustable from 0 to (100% - tA1) tA3: adjustable from 0 to 100% tA4: adjustable from 0 to (100% - tA3)</p> <p>t12 = ACC * (tA1(%) / 100 + tA2(%) / 100 + 1) t34 = DEC * (tA3(%) / 100 + tA4(%) / 100 + 1)</p> | | |
| I n r | [Ramp increment] | | [0,1] (0. 1) |
| () | This parameter is valid for [Acceleration] (A C C) , [Deceleration] (d E C) , [Acceleration 2] (A C 2) and [Deceleration 2] (d E 2) . | | |
| (1) | | | |
| 0. 0 1 | [0,01]: Ramp up to 99.99 seconds | | |
| 0. 1 | [0,1]: Ramp up to 999.9 seconds | | |
| 1 | [1]: Ramp up to 6,000 seconds | | |
| A C C | [Acceleration] | 0.00 to 6,000 s (2) | 3.0 s |
| () | Time to accelerate from 0 to the [Rated motor freq.] (F r 5) (page 74). To have repeatability in ramps, the value of this parameter must be set according to the possibility of the application. | | |
| (1) | | | |
| d E C | [Deceleration] | 0.00 to 6,000 s (2) | 3.0 s |
| () | Time to decelerate from the [Rated motor freq.] (F r 5) (page 74) to 0. To have repeatability in ramps, the value of this parameter must be set according to the possibility of the application. | | |
| (1) | | | |
| t A 1 | [Begin Acc round] | 0 to 100% | 10% |
| ★ | Rounding of start of acceleration ramp as a % of the [Acceleration] (A C C) or [Acceleration 2] (A C 2) ramp time. Can be set between 0 and 100%. | | |
| () | This parameter can be accessed if the [Ramp type] (r P t) is [Customized] (C U S) . | | |
| (1) | | | |

Parameters described in this page can be accessed by:

DRI- > CONF > FULL > FUN- > RPT-

| Code | Name / Description | Adjustment range | Factory setting | | | | | | | | | | | | | | | |
|--|--|---------------------|------------------|------|---|-------|----------|---|-------|----------|---|-------|----------|---|-------|----------|---------------------------------|------|
| <p>EA2</p> <p>★</p> <p>()</p> <p>(1)</p> | <p>[End Acc round]</p> <p>Rounding of end of acceleration ramp as a % of the [Acceleration] (AEC) or [Acceleration 2] (AE2) ramp time. Can be set between 0 and (100% - [Begin Acc round] (EA1)). This parameter can be accessed if the [Ramp type] (RPE) is [Customized] (CUS).</p> | 0 to 100% | 10% | | | | | | | | | | | | | | | |
| <p>EA3</p> <p>★</p> <p>()</p> <p>(1)</p> | <p>[Begin Dec round]</p> <p>Rounding of start of deceleration ramp as a % of the [Deceleration] (dEC) or [Deceleration 2] (dE2) ramp time. Can be set between 0 and 100%. This parameter can be accessed if the [Ramp type] (RPE) is [Customized] (CUS).</p> | 0 to 100% | 10% | | | | | | | | | | | | | | | |
| <p>EA4</p> <p>★</p> <p>()</p> <p>(1)</p> | <p>[End Dec round]</p> <p>Rounding of end of deceleration ramp as a % of the [Deceleration] (dEC) or [Deceleration 2] (dE2) ramp time. Can be set between 0 and (100% - [Begin Dec round] (EA3)). This parameter can be accessed if the [Ramp type] (RPE) is [Customized] (CUS).</p> | 0 to 100% | 10% | | | | | | | | | | | | | | | |
| <p>Frt</p> | <p>[Ramp 2 threshold]</p> <p>Ramp switching threshold The 2nd ramp is switched if the value of [Ramp 2 threshold] (Frt) is not 0 (0 deactivates the function) and the output frequency is greater than [Ramp 2 threshold] (Frt). Threshold ramp switching can be combined with [Ramp switch ass.] (RPS) switching as follows:</p> <table border="1"> <thead> <tr> <th>LI or bit</th> <th>Frequency</th> <th>Ramp</th> </tr> </thead> <tbody> <tr> <td>0</td> <td>< Frt</td> <td>ACC, dEC</td> </tr> <tr> <td>0</td> <td>> Frt</td> <td>AC2, dE2</td> </tr> <tr> <td>1</td> <td>< Frt</td> <td>AC2, dE2</td> </tr> <tr> <td>1</td> <td>> Frt</td> <td>AC2, dE2</td> </tr> </tbody> </table> | LI or bit | Frequency | Ramp | 0 | < Frt | ACC, dEC | 0 | > Frt | AC2, dE2 | 1 | < Frt | AC2, dE2 | 1 | > Frt | AC2, dE2 | 0 to 599 Hz according to rating | 0 Hz |
| LI or bit | Frequency | Ramp | | | | | | | | | | | | | | | | |
| 0 | < Frt | ACC, dEC | | | | | | | | | | | | | | | | |
| 0 | > Frt | AC2, dE2 | | | | | | | | | | | | | | | | |
| 1 | < Frt | AC2, dE2 | | | | | | | | | | | | | | | | |
| 1 | > Frt | AC2, dE2 | | | | | | | | | | | | | | | | |
| <p>RPS</p> | <p>[Ramp switch ass.]</p> <p>Identical to [Ref.1B channel] (Frlb) page 152.</p> | | [No] (n0) | | | | | | | | | | | | | | | |
| <p>AE2</p> <p>★</p> <p>()</p> <p>(1)</p> | <p>[Acceleration 2]</p> <p>Time to accelerate from 0 to the [Rated motor freq.] (Fr5). To have repeatability in ramps, the value of this parameter must be set according to the possibility of the application. This parameter can be accessed if [Ramp 2 threshold] (Frt) is greater than 0 or if [Ramp switch ass.] (RPS) is assigned.</p> | 0.00 to 6,000 s (2) | 5.0 s | | | | | | | | | | | | | | | |
| <p>dE2</p> <p>★</p> <p>()</p> <p>(1)</p> | <p>[Deceleration 2]</p> <p>Time to decelerate from [Rated motor freq.] (Fr5) to 0. To have repeatability in ramps, the value of this parameter must be set according to the possibility of the application. This parameter can be accessed if [Ramp 2 threshold] (Frt) is greater than 0 or if [Ramp switch ass.] (RPS) is assigned.</p> | 0.00 to 6,000 s (2) | 5.0 s | | | | | | | | | | | | | | | |

| Code | Name / Description | Adjustment range | Factory setting |
|---|--|------------------|--------------------|
| <i>brA</i> | [Dec ramp adapt.] | | [Yes] (YES) |
| <div style="border: 1px solid black; padding: 10px;"> <p style="margin: 0;">CAUTION</p> <p style="margin: 0;">RISK OF DAMAGE TO THE MOTOR</p> <p style="margin: 0;">Choose only [Dec ramp adapt.] (brA) = [Yes] (YES) or [No] (nD) if the motor is a permanent magnet synchronous motor, otherwise it will be demagnetized.</p> <p style="margin: 0;">Failure to follow these instructions can result in equipment damage.</p> </div> | | | |
| <p>Activating this function automatically adapts the deceleration ramp, if this has been set at a too low value according to the inertia of the load, which can cause an overvoltage detected fault.</p> <p>[Dec ramp adapt.] (brA) is forced to [No] (nD) if the brake logic control [Brake assignment] (bLC) is assigned (page 179). The function is incompatible with applications requiring:</p> <ul style="list-style-type: none"> - Positioning on a ramp. - The use of a braking resistor (the resistor would not operate correctly). | | | |
| <i>nD</i> | [No] (nD) : Function inactive | | |
| <i>YES</i> | [Yes] (YES) : Function active, for applications that do not require strong deceleration | | |
| The following selections appear depending on the rating of the drive and [Motor control type] (CtE) page 92. They enable stronger deceleration to be obtained than with [Yes] (YES) . Use comparative testing to determine your selection. | | | |
| <i>dYnA</i> | [High torq. A] (dYnA) : Addition of a constant current flow component. | | |
| When [Dec ramp adapt.] (brA) is configured on [High torq. x] (dYnX) , the dynamic performances for braking are improved by the addition of a current flow component. The aim is to increase the iron loss and magnetic energy stored in the motor. | | | |

(1) The parameter can also be accessed in the **[SETTINGS] (SEt-)** menu.

(2) Range 0.01 to 99.99 s or 0.1 to 999.9 s or 1 to 6,000 s according to **[Ramp increment] (Inr)** page 155.



These parameters only appear if the corresponding function has been selected in another menu. When the parameters can also be accessed and adjusted from within the configuration menu for the corresponding function, their description is detailed in these menus, on the pages indicated, to aid programming.

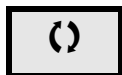

Parameter that can be modified during operation or when stopped.

Parameters described in this page can be accessed by:

DRI- > CONF > FULL > FUN- > STT-

STOP CONFIGURATION

| Code | Name / Description | Adjustment range | Factory setting |
|--|---|------------------|----------------------------|
| <i>F U n -</i> | [APPLICATION FUNCT.] (continued) | | |
| <i>S t t -</i> | [STOP CONFIGURATION] Note: Some types of stops cannot be used with all other functions. Follow the instructions on page 148. | | |
| <i>S t t</i> | [Type of stop] Stop mode on disappearance of the run command or appearance of a stop command. Note: If the "brake logic" function on page 179 has been enabled, or if [Low speed time out] (t L 5) page 83 or 199 is not 0, only ramp type stops may be configured. | | [Ramp stop] (r n P) |
| <i>r n P</i> <i>F 5 t</i> <i>n 5 t</i> <i>d C I</i> | [Ramp stop] (r n P): Stop on ramp [Fast stop] (F 5 t): Fast stop [Freewheel] (n 5 t): Freewheel stop [DC injection] (d C I): DC injection stop. Available only if [Motor control type] (t t t) page 92 is not set to [Sync. mot.] (5 Y n) . | | |
| <i>F F t</i> ★ ⌚ (1) | [Freewheel stop Thd.] Speed threshold below which the motor will switch to freewheel stop. This parameter supports switching from a ramp stop or a fast stop to a freewheel stop below a low speed threshold. This parameter can be accessed if [Type of stop] (S t t) is set to [Fast stop] (F 5 t) or [Ramp stop] (r n P) and if [Brake assignment] (b L t) or [Auto DC injection] (A d t) are configured. | 0.2 to 599 Hz | 0.2 Hz |
| <i>n 5 t</i> <i>n D</i> <i>L I I</i> ... | [Freewheel stop ass.] The stop is activated when the input or the bit changes to 0. If the input returns to state 1 and the run command is still active, the motor will only restart if [2/3 wire control] (t t t) page 73 is set to [2 wire] (t t) and if [2 wire type] (t t t) is set to [Level] (L E L) or [Fwd priority] (P F D) . If not, a new run command must be sent. | | [No] (n D) |
| <i>F 5 t</i> <i>n D</i> <i>L I I</i> ... | [Fast stop assign.] The stop is activated when the input changes to 0 or the bit changes to 1 (bit in [I/O profile] (I D) at 0). If the input returns to state 1 and the run command is still active, the motor will only restart if [2/3 wire control] (t t t) page 73 is set to [2 wire] (t t) and if [2 wire type] (t t t) is set to [Level] (L E L) or [Fwd priority] (P F D) . If not, a new run command must be sent. Note: This function cannot be used with certain other functions. Follow the instructions on page 148. | | [No] (n D) |
| <i>d C F</i> ★ ⌚ (1) | [Ramp divider] This parameter can be accessed if [Type of stop] (S t t) is set to [Fast stop] (F 5 t) and if [Fast stop assign.] (F 5 t) is not [No] (n D) and if [Stop type] (P R 5) is set to [Fast stop] (F 5 t) . The ramp that is enabled ([Deceleration] (d E t) or [Deceleration 2] (d E 2)) is then divided by this coefficient when stop requests are sent. Value 0 corresponds to a minimum ramp time. | 0 to 10 | 4 |

| Code | Name / Description | Adjustment range | Factory setting |
|---|--|--------------------|----------------------------|
| <p><i>d C I</i></p> <p><i>n 0</i> <i>L I I</i> <i>. . .</i></p> | <p>[DC injection assign.]</p> <div style="border: 1px solid black; padding: 10px; text-align: center;"> <p>⚠ WARNING</p> <p>NO HOLDING TORQUE</p> <ul style="list-style-type: none"> • DC injection braking does not provide any holding torque at zero speed. • DC injection braking does not work when there is a loss of power or when the drive detects a fault. • Where necessary, use a separate brake to maintain torque levels. <p>Failure to follow these instructions can result in death, serious injury, or equipment damage.</p> </div> <p>DC injection braking is initiated when the assigned input or bit changes to state 1. If the input returns to state 0 and the run command is still active, the motor will only restart if [2/3 wire control] (<i>L C C</i>) page 73 is set to [2 wire] (<i>C C</i>) and if [2 wire type] (<i>L C L</i>) is set to [Level] (<i>L E L</i>) or [Fwd priority] (<i>P F 0</i>). If not, a new run command must be sent. Note: This function cannot be used with certain other functions. Follow the instructions on page 148.</p> <p><i>n 0</i> [No] (<i>n 0</i>): Not assigned <i>L I I</i> [LI1] (<i>L I I</i>): Logical input LI1 <i>. . .</i> [...] (<i>. . .</i>): See the assignment conditions on page 138</p> | | [No] (<i>n 0</i>) |
| <p><i>I d C</i></p> <p>★ ↻ (1) (3)</p> | <p>[DC inject. level 1]</p> <div style="border: 1px solid black; padding: 10px; text-align: center;"> <p>⚠ WARNING</p> <p>NO HOLDING TORQUE</p> <ul style="list-style-type: none"> • DC injection braking does not provide any holding torque at zero speed. • DC injection braking does not work when there is a loss of power or when the drive detects a fault. • Where necessary, use a separate brake to maintain torque levels. <p>Failure to follow these instructions can result in death, serious injury, or equipment damage.</p> </div> <div style="border: 1px solid black; padding: 10px; text-align: center;"> <p>CAUTION</p> <p>RISK OF DAMAGE TO THE MOTOR</p> <p>Check that the motor will withstand this current without overheating. Failure to follow these instructions can result in equipment damage.</p> </div> <p>Level of DC injection braking current activated via logic input or selected as stop mode. This parameter can be accessed if [Type of stop] (<i>S E E</i>) is set to [DC injection] (<i>d C I</i>) or if [DC injection assign.] (<i>d C I</i>) is not [No] (<i>n 0</i>).</p> | 0.1 to 1.41 In (2) | 0.64 In (2) |
| <p><i>L d I</i></p> <p>★ ↻ (1) (3)</p> | <p>[DC injection time 1]</p> <div style="border: 1px solid black; padding: 10px; text-align: center;"> <p>CAUTION</p> <p>RISK OF DAMAGE TO THE MOTOR</p> <ul style="list-style-type: none"> • Long periods of DC injection braking can cause overheating and damage the motor. • Protect the motor by avoiding long periods of DC injection braking. <p>Failure to follow these instructions can result in equipment damage.</p> </div> <p>Maximum current injection time [DC inject. level 1] (<i>I d C</i>). After this time, the injection current becomes [DC inject. level 2] (<i>I d C 2</i>). This parameter can be accessed if [Type of stop] (<i>S E E</i>) is set to [DC injection] (<i>d C I</i>) or if [DC injection assign.] (<i>d C I</i>) is not set to [No] (<i>n 0</i>).</p> | 0.1 to 30 s | 0.5 s |

Parameters described in this page can be accessed by:

DRI- > CONF > FULL > FUN- > STT-

| Code | Name / Description | Adjustment range | Factory setting |
|------------------------------|--|--|-------------------------------------|
| <i>I d C 2</i> | [DC inject. level 2] | 0.1 In (2) to [DC inject. level 1] (<i>I d C</i>) | 0.5 In (2) |
| ★ (1) (3) | CAUTION | | |
| | <p>RISK OF DAMAGE TO THE MOTOR Check that the motor will withstand this current without overheating. Failure to follow these instructions can result in equipment damage.</p> <p>Injection current activated by logic input or selected as stop mode, once period of time [DC injection time 1] (<i>t d I</i>) has elapsed. This parameter can be accessed if [Type of stop] (<i>S E E</i>) is set to [DC injection] (<i>d C I</i>) or if [DC injection assign.] (<i>d C I</i>) is not set to [No] (<i>n 0</i>).</p> | | |
| <i>t d C</i> | [DC injection time 2] | 0.1 to 30 s | 0.5 s |
| ★ (1) (3) | CAUTION | | |
| | <p>RISK OF DAMAGE TO THE MOTOR</p> <ul style="list-style-type: none"> • Long periods of DC injection braking can cause overheating and damage the motor. • Protect the motor by avoiding long periods of DC injection braking. <p>Failure to follow these instructions can result in equipment damage.</p> <p>Maximum injection time [DC inject. level 2] (<i>I d C 2</i>) for injection, selected as stop mode only. This parameter can be accessed if [Stop type] (<i>S E E</i>) is set to [DC injection] (<i>d C I</i>).</p> | | |
| <i>d 0 t d</i> | [Dis. operat opt code] | | [Ramp stop] (<i>r n P</i>) |
| <i>n S E</i> <i>r n P</i> | <p>Disable operation stop mode.</p> <p>[Freewheel] (<i>n S E</i>): Disable drive function [Ramp stop] (<i>r n P</i>): Ramp stop then disable drive function</p> | | |

- (1) The parameter can also be accessed in the **[SETTINGS]** (*S E E -*) menu.
- (2) In corresponds to the rated drive current indicated in the Installation manual and on the drive nameplate.
- (3) These settings are independent of the **[AUTO DC INJECTION]** (*R d C -*) function.





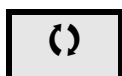



These parameters only appear if the corresponding function has been selected in another menu. When the parameters can also be accessed and adjusted from within the configuration menu for the corresponding function, their description is detailed in these menus, on the pages indicated, to aid programming.



Parameter that can be modified during operation or when stopped.

AUTO DC INJECTION

| Code | Name / Description | Adjustment range | Factory setting |
|---|--|------------------|----------------------|
| <i>F U n -</i> | [APPLICATION FUNCT.] (continued) | | |
| <i>A d C -</i> | [AUTO DC INJECTION] | | |
| <i>A d C</i> | [Auto DC injection] | | [Yes] (Y E 5) |
|  | <div style="background-color: black; color: white; text-align: center; padding: 5px;">⚠ ⚠ DANGER</div> <p>HAZARD OF ELECTRIC SHOCK, EXPLOSION OR ARC FLASH When [Auto DC injection] (A d C) is set to [Continuous] (C E), the injection of current is done even if a run command has not been sent. Check this action will not endanger personnel or equipment in any way. Failure to follow these instructions will result in death or serious injury.</p> | | |
|  2 s | <div style="text-align: center;">⚠ WARNING</div> <p>NO HOLDING TORQUE</p> <ul style="list-style-type: none"> • DC injection braking does not provide any holding torque at zero speed. • DC injection braking does not work when there is a loss of power or when the drive detects a fault. • Where necessary, use a separate brake to maintain torque levels. <p>Failure to follow these instructions can result in death, serious injury, or equipment damage.</p> <p>Automatic current injection on stopping (at the end of the ramp). Note: There is an interlock between this function and [Motor fluxing] (F L U) page 83. If [Motor fluxing] (F L U) is set to [Continuous] (F C E), [Auto DC injection] (A d C) must be [No] (n D). Note: [Auto DC injection] (A d C) is set to [No] (n D) when [Motor control type] (C E E) page 92 is set to [Sync. mot.] (S Y n). [Auto DC injection] (A d C) is forced to [No] (n D) when [Brake assignment] (b L C) page 179 is not set to [No] (n D). This parameter gives rise to the injection of current even if a run command has not been sent. It can be accessed with the drive running.</p> <p><i>n D</i> [No] (n D): No injection <i>Y E 5</i> [Yes] (Y E 5): Adjustable injection time <i>C E</i> [Continuous] (C E): Continuous standstill injection</p> | | |
| <i>S d C I</i> | [Auto DC inj. level 1] | 0 to 1.2 In (2) | 0.7 In (2) |
|   (1) | <div style="text-align: center;">CAUTION</div> <p>RISK OF DAMAGE TO THE MOTOR Check that the motor will withstand this current without overheating. Failure to follow these instructions can result in equipment damage.</p> <p>Level of standstill DC injection current [Auto DC injection] (A d C) is not [No] (n D).</p> | | |
| <i>t d C I</i> | [Auto DC inj. time 1] | 0.1 to 30 s | 0.5 s |
|   (1) | <div style="text-align: center;">CAUTION</div> <p>RISK OF DAMAGE TO THE MOTOR</p> <ul style="list-style-type: none"> • Long periods of DC injection braking can cause overheating and damage the motor. • Protect the motor by avoiding long periods of DC injection braking. <p>Failure to follow these instructions can result in equipment damage.</p> <p>Standstill injection time. This parameter can be accessed if [Auto DC injection] (A d C) is not set to [No] (n D). If [Motor control type] (C E E) page 92 is set to [Sync. mot.] (S Y n), this time corresponds to the zero speed maintenance time.</p> | | |

Parameters described in this page can be accessed by:

DRI- > CONF > FULL > FUN- > ADC-

| Code | Name / Description | Adjustment range | Factory setting | | | | | | | | | | | | | | | | | | |
|---|---|------------------|-----------------|-----------|-----|---|--|----|-----|--|----|-----|--|-------------|--|--|-------|--|--|-----------|-----|
| <p>S d C 2</p> <p>★</p> <p>(1)</p> | <p>[Auto DC inj. level 2]</p> <p>CAUTION</p> <p>RISK OF DAMAGE TO THE MOTOR Check that the motor will withstand this current without overheating. Failure to follow these instructions can result in equipment damage.</p> <p>2nd level of standstill DC injection current. This parameter can be accessed if [Auto DC injection] (AdC) is not [No] (nD).</p> | 0 to 1.2 In (2) | 0.5 In (2) | | | | | | | | | | | | | | | | | | |
| <p>t d C 2</p> <p>★</p> <p>(1)</p> | <p>[Auto DC inj. time 2]</p> <p>CAUTION</p> <p>RISK OF DAMAGE TO THE MOTOR • Long periods of DC injection braking can cause overheating and damage the motor. • Protect the motor by avoiding long periods of DC injection braking. Failure to follow these instructions can result in equipment damage.</p> <p>2nd standstill injection time. This parameter can be accessed if [Auto DC injection] (AdC) is set to [Yes] (yE5).</p> <table border="1"> <thead> <tr> <th>AdC</th> <th>SdC2</th> <th>Operation</th> </tr> </thead> <tbody> <tr> <td>YES</td> <td>x</td> <td></td> </tr> <tr> <td>Ct</td> <td>≠ 0</td> <td></td> </tr> <tr> <td>Ct</td> <td>= 0</td> <td></td> </tr> <tr> <td colspan="2">Run command</td> <td></td> </tr> <tr> <td colspan="2">Speed</td> <td></td> </tr> </tbody> </table> | AdC | SdC2 | Operation | YES | x | | Ct | ≠ 0 | | Ct | = 0 | | Run command | | | Speed | | | 0 to 30 s | 0 s |
| AdC | SdC2 | Operation | | | | | | | | | | | | | | | | | | | |
| YES | x | | | | | | | | | | | | | | | | | | | | |
| Ct | ≠ 0 | | | | | | | | | | | | | | | | | | | | |
| Ct | = 0 | | | | | | | | | | | | | | | | | | | | |
| Run command | | | | | | | | | | | | | | | | | | | | | |
| Speed | | | | | | | | | | | | | | | | | | | | | |

(1) The parameter can also be accessed in the **[SETTINGS] (5 E E -)** menu.

(2) In corresponds to the rated drive current indicated in the Installation manual and on the drive nameplate.



These parameters only appear if the corresponding function has been selected in another menu. When the parameters can also be accessed and adjusted from within the configuration menu for the corresponding function, their description is detailed in these menus, on the pages indicated, to aid programming.

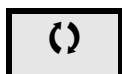

Parameter that can be modified during operation or when stopped.



To change the assignment of this parameter, press the ENT key for 2 s.

JOG

| Code | Name / Description | Adjustment range | Factory setting |
|---------------------------------------|---|------------------|----------------------|
| FUn- | [APPLICATION FUNCT.] (continued) | | |
| JOG- | [JOG] Note: This function cannot be used with certain other functions. Follow the instructions on page 148. | | |
| JOG | [JOG] Pulse operation. The JOG function is only active if the command channel and the reference channels are on the terminals. The function is active when the assigned input or bit is at 1. Example: 2-wire control operation (tCC = 2C). | | [LI3] (L I 3) |
| | <p>The diagram shows the relationship between several signals during JOG operation. The top signal is Motor frequency, which ramps up, then has a 'Ramp DEC/DE2' period, and then a 'Ramp forced to 0.1 s' period. Below it are Reference and JGF reference signals. The LI (JOG) signal is a pulse that triggers the operation. Forward and Reverse signals are also shown as pulses. A 'JGt' (jog time) interval is indicated during the forward pulse.</p> | | |
| nD LI1 ... | [No] (nD): Not assigned [LI1] (L I 1): Logical input LI1 [...] (. . .): See the assignment conditions on page 138 (not [Cd00] (C d 0 0) to [Cd15] (C d 1 5)) | | |
| JGF ★ ⌚ (1) | [Jog frequency] Reference in jog operation. This parameter can be accessed if [JOG] (JOG) is not set to [No] (nD) . | 0 to 10 Hz | 10 Hz |

Parameters described in this page can be accessed by:

DRI- > CONF > FULL > FUN- > JOG-

| Code | Name / Description | Adjustment range | Factory setting |
|-------|---|------------------|-----------------|
| J G L | [Jog delay] | 0 to 2.0 s | 0.5 s |
| ★ | Anti-repeat delay between 2 consecutive jog operations. | | |
| ↻ | This parameter can be accessed if [JOG] (J G L) is not set to [No] (n D). | | |
| (1) | | | |

(1) The parameter can also be accessed in the **[SETTINGS]** (S E L -) menu.



These parameters only appear if the corresponding function has been selected in another menu. When the parameters can also be accessed and adjusted from within the configuration menu for the corresponding function, their description is detailed in these menus, on the pages indicated, to aid programming.



Parameter that can be modified during operation or when stopped.



To change the assignment of this parameter, press the ENT key for 2 s.

PRESET SPEEDS

2, 4, 8 or 16 speeds can be preset, requiring 1, 2, 3 or 4 logic inputs respectively.

Note:

You must configure 2 and 4 speeds in order to obtain 4 speeds.

You must configure 2, 4 and 8 speeds in order to obtain 8 speeds.

You must configure 2, 4, 8, and 16 speeds in order to obtain 16 speeds.

Combination table for preset speed inputs

| 16 speeds LI (PS16) | 8 speeds LI (PS8) | 4 speeds LI (PS4) | 2 speeds LI (PS2) | Speed reference |
|------------------------|----------------------|----------------------|----------------------|-----------------|
| 0 | 0 | 0 | 0 | Reference (1) |
| 0 | 0 | 0 | 1 | SP2 |
| 0 | 0 | 1 | 0 | SP3 |
| 0 | 0 | 1 | 1 | SP4 |
| 0 | 1 | 0 | 0 | SP5 |
| 0 | 1 | 0 | 1 | SP6 |
| 0 | 1 | 1 | 0 | SP7 |
| 0 | 1 | 1 | 1 | SP8 |
| 1 | 0 | 0 | 0 | SP9 |
| 1 | 0 | 0 | 1 | SP10 |
| 1 | 0 | 1 | 0 | SP11 |
| 1 | 0 | 1 | 1 | SP12 |
| 1 | 1 | 0 | 0 | SP13 |
| 1 | 1 | 0 | 1 | SP14 |
| 1 | 1 | 1 | 0 | SP15 |
| 1 | 1 | 1 | 1 | SP16 |

(1) See the diagram on page [132](#): Reference 1 = (SP1).

Parameters described in this page can be accessed by:

DRI- > CONF > FULL > FUN- > PSS-

| Code | Name / Description | Adjustment range | Factory setting |
|--|---|------------------|---------------------|
| F U n - | [APPLICATION FUNCT.] (continued) | | |
| P 5 5 - | [PRESET SPEEDS] Note: This function cannot be used with certain other functions. Follow the instructions on page 148 . | | |
| P 5 2 <i>n D</i> <i>L I I</i> <i>. . .</i> | [2 preset speeds] [No] (<i>n D</i>): Not assigned [LI1] (<i>L I I</i>): Logical input LI1 [...] (<i>. . .</i>): See the assignment conditions on page 138 | | [No] (<i>n D</i>) |
| P 5 4 | [4 preset speeds] Identical to [2 preset speeds] (<i>P 5 2</i>) page 166 . To obtain 4 speeds, you must also configure 2 speeds. | | [No] (<i>n D</i>) |
| P 5 8 | [8 preset speeds] Identical to [2 preset speeds] (<i>P 5 2</i>) page 166 . To obtain 8 speeds, you must also configure 2 and 4 speeds. | | [No] (<i>n D</i>) |
| P 5 16 | [16 preset speeds] Identical to [2 preset speeds] (<i>P 5 2</i>) page 166 . To obtain 16 speeds, you must also configure 2, 4 and 8 speeds. | | [No] (<i>n D</i>) |
| S P 2 ★ ⌚ (1) | [Preset speed 2] Preset speed 2. See the Combination table for preset PID references page 192 . | 0 to 599 Hz | 10 Hz |
| S P 3 ★ ⌚ (1) | [Preset speed 3] Preset speed 3. See the Combination table for preset PID references page 192 . | 0 to 599 Hz | 15 Hz |
| S P 4 ★ ⌚ (1) | [Preset speed 4] Preset speed 4. See the Combination table for preset PID references page 192 . | 0 to 599 Hz | 20 Hz |
| S P 5 ★ ⌚ (1) | [Preset speed 5] Preset speed 5. See the Combination table for preset PID references page 192 . | 0 to 599 Hz | 25 Hz |
| S P 6 ★ ⌚ (1) | [Preset speed 6] Preset speed 6. See the Combination table for preset PID references page 192 . | 0 to 599 Hz | 30 Hz |
| S P 7 ★ ⌚ (1) | [Preset speed 7] Preset speed 7. See the Combination table for preset PID references page 192 . | 0 to 599 Hz | 35 Hz |





Parameters described in this page can be accessed by:

DRI- > CONF > FULL > FUN- > PSS-

| Code | Name / Description | Adjustment range | Factory setting |
|--------------------------------|---|------------------|-----------------|
| 5 P 8 ★ ⌚ (1) | [Preset speed 8] Preset speed 8. See the Combination table for preset PID references page 192 . | 0 to 599 Hz | 40 Hz |
| 5 P 9 ★ ⌚ (1) | [Preset speed 9] Preset speed 9. See the Combination table for preset PID references page 192 . | 0 to 599 Hz | 45 Hz |
| 5 P 10 ★ ⌚ (1) | [Preset speed 10] Preset speed 10. See the Combination table for preset PID references page 192 . | 0 to 599 Hz | 50 Hz |
| 5 P 11 ★ ⌚ (1) | [Preset speed 11] Preset speed 11. See the Combination table for preset PID references page 192 . | 0 to 599 Hz | 55 Hz |
| 5 P 12 ★ ⌚ (1) | [Preset speed 12] Preset speed 12. See the Combination table for preset PID references page 192 . | 0 to 599 Hz | 60 Hz |
| 5 P 13 ★ ⌚ (1) | [Preset speed 13] Preset speed 13. See the Combination table for preset PID references page 192 . | 0 to 599 Hz | 70 Hz |
| 5 P 14 ★ ⌚ (1) | [Preset speed 14] Preset speed 14. See the Combination table for preset PID references page 192 . | 0 to 599 Hz | 80 Hz |
| 5 P 15 ★ ⌚ (1) | [Preset speed 15] Preset speed 15. See the Combination table for preset PID references page 192 . | 0 to 599 Hz | 90 Hz |
| 5 P 16 ★ ⌚ (1) | [Preset speed 16] Preset speed 16. The appearance of these [Preset speed x] (5 Px) parameters is determined by the number of speeds configured. See the Combination table for preset PID references page 192 . | 0 to 599 Hz | 100 Hz |

Parameters described in this page can be accessed by:

DRI- > CONF > FULL > FUN- > PSS-

| Code | Name / Description | Adjustment range | Factory setting |
|--|--|------------------|-----------------|
| <i>JPF</i>  | [Skip Frequency] Skip frequency. This parameter helps to prevent prolonged operation within an adjustable range around the regulated frequency. This function can be used to help to prevent a critical speed, which would cause resonance, being reached. Setting the function to 0 renders it inactive. | 0 to 599 Hz | 0 Hz |
| <i>JF2</i>  | [Skip Frequency 2] 2nd skip frequency. This parameter helps to prevent prolonged operation within an adjustable range around the regulated frequency. This function can be used to help to prevent a critical speed, which would cause resonance, being reached. Setting the function to 0 renders it inactive. | 0 to 599 Hz | 0 Hz |
| <i>JF3</i>  | [3rd Skip Frequency] 3rd skip frequency. This parameter helps to prevent prolonged operation within an adjustable range around the regulated frequency. This function can be used to help to prevent a critical speed, which would cause resonance, being reached. Setting the function to 0 renders it inactive. | 0 to 599 Hz | 0 Hz |
| <i>JFH</i>   | [Skip.Freq.Hysteresis] This parameter is visible if at least one skip frequency [Skip Frequency] (<i>JPF</i>), [Skip Frequency 2] (<i>JF2</i>) or [3rd Skip Frequency] (<i>JF3</i>) is different from 0. Skip frequency range: between ($JPF - JFH$) and ($JPF + JFH$), for example. This adjustment is common to the 3 frequencies (<i>JPF</i> , <i>JF2</i> , <i>JF3</i>). | 0.1 to 10 Hz | 1 Hz |

(1) The parameter can also be accessed in the **[SETTINGS]** (*SELE*) menu.



These parameters only appear if the corresponding function has been selected in another menu. When the parameters can also be accessed and adjusted from within the configuration menu for the corresponding function, their description is detailed in these menus, on the pages indicated, to aid programming.

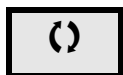

Parameter that can be modified during operation or when stopped.

+/- SPEED

Two types of operations are available:

- **Use of single action keys:** Two logic inputs are required in addition to the operating direction(s). The input assigned to the “+ speed” command increases the speed, the input assigned to the “- speed” command decreases the speed.
- **Use of double action keys:** Only one logic input assigned to “+ speed” is required.

+/- speed with double-press buttons:

Description: 1 button pressed twice (2 steps) for each direction of rotation. A contact closes each time the button is pressed.

| | Released (- speed) | 1st press (speed maintained) | 2nd press (faster) |
|-----------------------|--------------------|------------------------------|--------------------|
| Forward button | – | a | a and b |
| Reverse button | – | c | c and d |

Example of wiring:

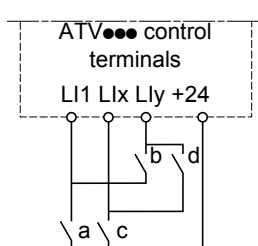

L1: Forward
Lx: Reverse
Lly: + speed

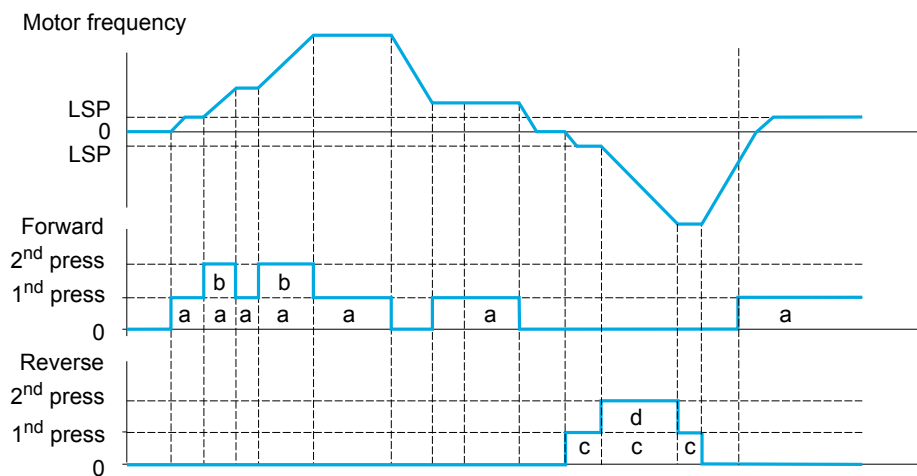

Do not use this +/-speed type with 3-wire control.

Whichever type of operation is selected, the max. speed is set by **[High speed] (H5P)** (see page 75).

Note:

If the reference is switched via **[Ref. 2 switching] (rFL)** (see page 140) from any one reference channel to another reference channel with “+/- speed”, the value of reference **[Output frequency] (rFr)** (after ramp) may be copied at the same time in accordance with the **[Copy channel 1 --> 2] (CDP)** parameter (see page 141).

If the reference is switched via **[Ref. 2 switching] (rFL)** (see page 140) from one reference channel to any other reference channel with “+/- speed”, the value of reference **[Output frequency] (rFr)** (after ramp) is copied at the same time.

This helps to prevent the speed being incorrectly reset to zero when switching takes place.

Parameters described in this page can be accessed by:

DRI- > CONF > FULL > FUN- > UPD-

| Code | Name / Description | Adjustment range | Factory setting |
|---|---|------------------|----------------------------|
| <i>F U n -</i> | [APPLICATION FUNCT.] (continued) | | |
| <i>U P d -</i> | [+/- SPEED] This function can be accessed if reference channel [Ref.2 channel] (<i>F r 2</i>) is set to [+/-Speed] (<i>U P d t</i>), see page 140 . Note: This function cannot be used with certain other functions. Follow the instructions on page 148 . | | |
| <i>U S P</i> | [+ speed assignment] Function active if the assigned input or bit is at 1. | | [No] (<i>n 0</i>) |
| <i>n 0</i> <i>L I 1</i> <i>...</i> | [No] (<i>n 0</i>): Not assigned [LI1] (<i>L I 1</i>): Logical input LI1 [...] (<i>...</i>): See the assignment conditions on page 138 | | |
| <i>d S P</i> | [-Speed assignment] See the assignment conditions on page 138 Function active if the assigned input or bit is at 1. | | [No] (<i>n 0</i>) |
| <i>S t r</i> | [Reference saved] Associated with the "+/- speed" function, this parameter can be used to save the reference: <ul style="list-style-type: none"> - When the run commands disappear (saved to RAM). - When the line supply or the run commands disappear (saved to EEPROM). Therefore, the next time the drive starts up, the speed reference is the last reference saved. | | [No] (<i>n 0</i>) |
| ★ <i>n 0</i> <i>r A M</i> <i>E E P</i> | [No] (<i>n 0</i>): No save (the next time the drive starts up, the speed reference is [Low speed] (<i>L S P</i>), see page 75) [RAM] (<i>r A M</i>): Saved in RAM [EEProm] (<i>E E P</i>): Saved in EEPROM | | |



These parameters only appear if the corresponding function has been selected in another menu. When the parameters can also be accessed and adjusted from within the configuration menu for the corresponding function, their description is detailed in these menus, on the pages indicated, to aid programming.

+/- SPEED AROUND A REFERENCE

The reference is given by **[Ref.1 channel] (Fr 1)** or **[Ref.1B channel] (Fr 1b)** with summing/subtraction/multiplication functions and preset speeds if relevant (see the diagram on page 132). For improved clarity, we will call this reference A. The action of the +speed and -speed keys can be set as a % of this reference A. On stopping, the reference (A +/- speed) is not saved, so the drive restarts with reference A+ only.

The maximum total reference is limited by **[High speed] (HSP)** and the minimum reference by **[Low speed] (LSP)**, see page 75.

Example of 2-wire control:

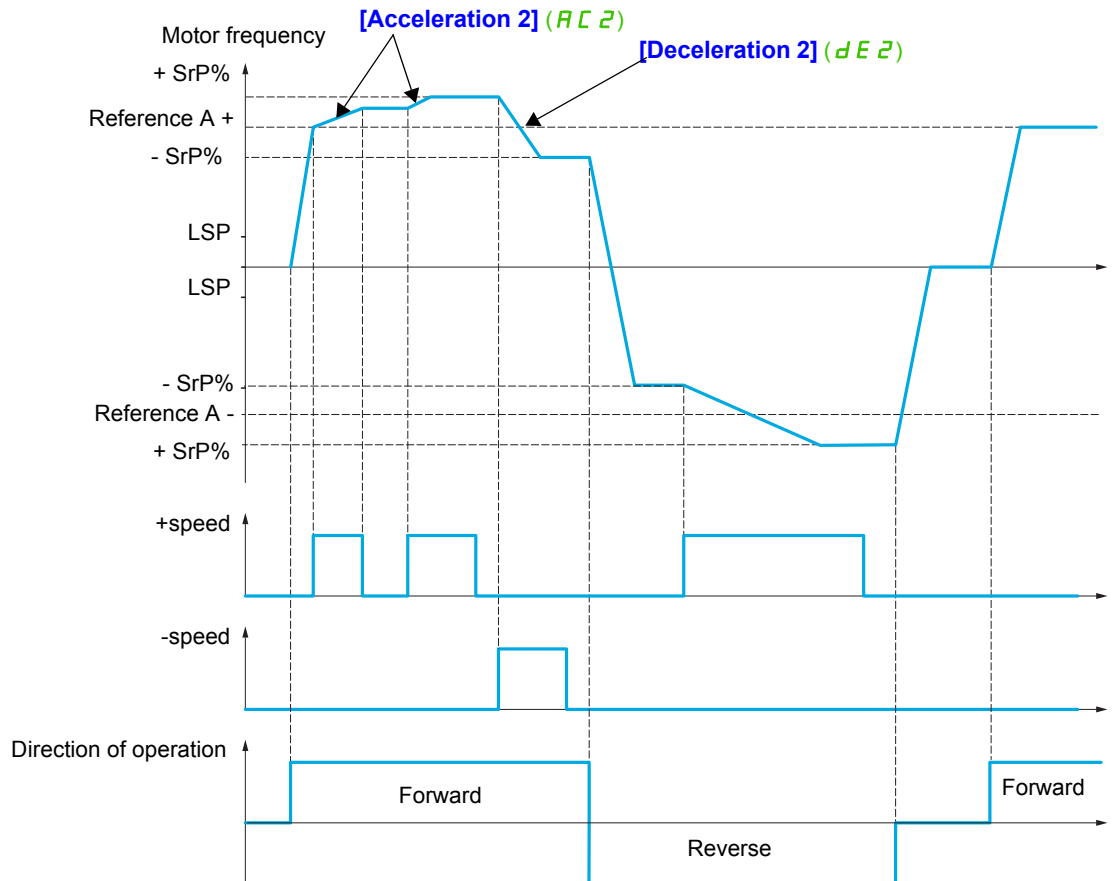

Parameters described in this page can be accessed by:

DRI- > CONF > FULL > FUN- > SRE-

| Code | Name / Description | Adjustment range | Factory setting |
|--|--|---------------------|-------------------|
| F U n - | [APPLICATION FUNCT.] (continued) | | |
| S r E - | [+/-SPEED AROUND REF.] The function can be accessed for reference channel [Ref.1 channel] (F r I) . Note: This function cannot be used with certain other functions. Follow the instructions on page 151 . | | |
| U S I <i>n D</i> <i>L I I</i> <i>...</i> | [+ speed assignment] No] (n D): Not assigned [L1] (L I I): Logical input LI1 [...] (. . .): See the assignment conditions on page 138 | | [No] (n D) |
| d S I | [-Speed assignment] See the assignment conditions on page 138 Function active if the assigned input or bit is at 1. | | [No] (n D) |
| S r P ★ () | [+/-Speed limitation] This parameter limits the variation range with +/- speed as a % of the reference. The ramps used in this function are [Acceleration 2] (A C 2) and [Deceleration 2] (d E 2) . This parameter can be accessed if +/- speed is assigned. | 0 to 50% | 10% |
| A C 2 ★ () (1) | [Acceleration 2] Time to accelerate from 0 to the [Rated motor freq.] (F r 5) . To have repeatability in ramps, the value of this parameter must be set according to the possibility of the application. This parameter can be accessed if [+/- speed] (t U d) is assigned. | 0.00 to 6,000 s (2) | 5.00 s |
| d E 2 ★ () (1) | [Deceleration 2] Time to decelerate from the [Rated motor freq.] (F r 5) to 0. To have repeatability in ramps, the value of this parameter must be set according to the possibility of the application. This parameter can be accessed if [+/- speed] (t U d) is assigned. | 0.00 to 6,000 s (2) | 5.00 s |

(1) The parameter can also be accessed in the **[SETTINGS] (S E t -)** menu.

(2) Range 0.01 to 99.99 s or 0.1 to 999.9 s or 1 to 6,000 s according to **[Ramp increment] (I n r)** page [155](#).



These parameters only appear if the corresponding function has been selected in another menu. When the parameters can also be accessed and adjusted from within the configuration menu for the corresponding function, their description is detailed in these menus, on the pages indicated, to aid programming.

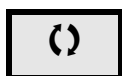

Parameter that can be modified during operation or when stopped.

REFERENCE MEMORIZING

Saving a speed reference value using a logic input command lasting longer than 0.1 s.

- This function is used to control the speed of several drives alternately via a single analog reference and one logic input for each drive.
- It is also used to confirm a line reference (communication bus or network) on several drives via a logic input. This allows movements to be synchronized by getting rid of variations when the reference is set.
- The reference is acquired 100 ms after the rising edge of the request. A new reference is not then acquired until a new request is made.

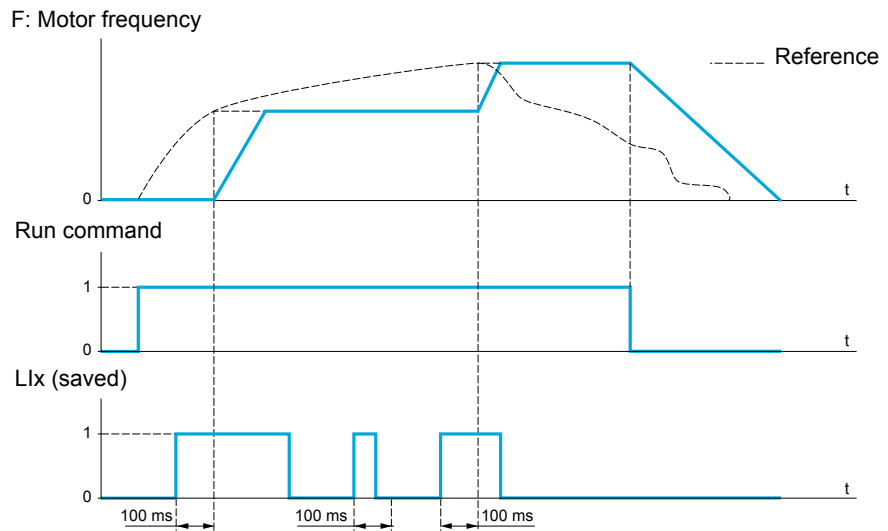

| Code | Name / Description | Adjustment range | Factory setting |
|----------------|--|------------------|-------------------|
| F U n - | [APPLICATION FUNCT.] (continued) | | |
| S P n - | [MEMO REFERENCE] | | |
| S P n | [Ref. memo ass.] Assignment to a logic input. Function active if the assigned input is at active state. | | [No] (n 0) |
| n 0 | [No] (n 0) : Not assigned | | |
| L I I | [LI1] (L I I) : Logical input LI1 | | |
| . . . | [...] (. . .) : See the assignment conditions on page 138 | | |

Parameters described in this page can be accessed by:

DRI- > CONF > FULL > FUN- > FLI-

FLUXING BY LOGIC INPUT

| Code | Name / Description | Adjustment range | Factory setting |
|---|--|------------------|----------------------------|
| <i>F U n -</i> | [APPLICATION FUNCT.] (continued) | | |
| <i>F L I -</i> | [FLUXING BY LI] | | |
| <i>F L U</i> | [Motor fluxing] | | [No] (<i>F n D</i>) |
| <p>★</p> <p>⌚</p> <p>(1)</p> <p>⌚ 2 s</p> | <p>⚠ ⚠ DANGER</p> <p>HAZARD OF ELECTRIC SHOCK, EXPLOSION OR ARC FLASH When [Motor fluxing] (<i>F L U</i>) is set to [Continuous] (<i>F C E</i>), the drive automatically builds up flux. Check this action will not endanger personnel or equipment in any way. Failure to follow these instructions will result in death or serious injury.</p> | | |
| | <p>CAUTION</p> <p>RISK OF DAMAGE TO THE MOTOR Check that the motor will withstand this current without overheating. Failure to follow these instructions can result in equipment damage.</p> | | |
| <i>F n C</i> | [Not cont.] (<i>F n C</i>): Non-continuous mode | | |
| <i>F C E</i> | [Continuous] (<i>F C E</i>): Continuous mode. This option is not possible if [Auto DC injection] (<i>A d C</i>) page 161 is [Yes] (<i>Y E S</i>) or if [Type of stop] (<i>S E E</i>) page 158 is [Freewheel] (<i>n S E</i>). | | |
| <i>F n D</i> | [No] (<i>F n D</i>): Function inactive | | |
| | <p>In order to obtain rapid high torque on startup, magnetic flux needs to already have been established in the motor. In [Continuous] (<i>F C E</i>) mode, the drive automatically builds up flux when it is powered up. In [Not cont.] (<i>F n C</i>) mode, fluxing occurs when the motor starts up. The flux current is greater than [Rated mot. current] (<i>n C r</i>) (configured rated motor current) when the flux is established and is then adjusted to the motor magnetizing current.</p> <p>If [Motor control type] (<i>C E E</i>) page 92 is set to [Sync. mot.] (<i>S Y n</i>), the [Motor fluxing] (<i>F L U</i>) parameter causes the alignment of the rotor and not the fluxing. If [Brake assignment] (<i>b L E</i>) page 179 is not [No] (<i>n D</i>), the [Motor fluxing] (<i>F L U</i>) parameter has no effect.</p> | | |
| <i>F L I</i> | [Fluxing assignment] | | [No] (<i>n D</i>) |
| <p>★</p> | <p>CAUTION</p> <p>RISK OF DAMAGE TO THE MOTOR Check that the motor will withstand this current without overheating. Failure to follow these instructions can result in equipment damage.</p> | | |
| | <p>Assignment is only possible if [Motor fluxing] (<i>F L U</i>) is set to [Not cont.] (<i>F n C</i>). If an LI or a bit is assigned to the motor fluxing command, flux is built up when the assigned input or bit is at 1. If an LI or a bit has not been assigned, or if the assigned LI or bit is at 0 when a run command is sent, fluxing occurs when the motor starts.</p> | | |
| <i>n D</i> | [No] (<i>n D</i>): Not assigned | | |
| <i>L I I</i> | [LI1] (<i>L I I</i>): Logical input LI1 | | |
| <i>. . .</i> | [...] (<i>. . .</i>): See the assignment conditions on page 138 | | |

Parameters described in this page can be accessed by: DRI- > CONF > FULL > FUN- > FLI-

| Code | Name / Description | Adjustment range | Factory setting |
|--------------------------|---|------------------|-----------------------------|
| <i>PSL</i> | [Angle setting type] | | [PSIO align.] (PSIO) |
| ★ | Mode for measuring the phase-shift angle. Visible only if [Motor control type] (CLL) is set to [Sync. mot.] (SYN) . [PSI align] (PSI) and [PSIO align] (PSIO) are working for all type of synchronous motors. [SPM align] (SPM) and [IPM align] (IPM) increase performances depending on the type of synchronous motor. | | |
| <i>IPM</i> <i>SPM</i> | [IPM align] (IPM) : Alignment for IPM motor. Alignment mode for Interior-buried Permanent Magnet motor (usually, this kind of motor has a high saliency level). It uses high frequency injection, which is less noisy than standard alignment mode. [SPM align] (SPM) : Alignment for SPM motor. Mode for Surface-mounted Permanent Magnet motor (usually, this kind of motor has a medium or low saliency level). It uses high frequency injection, which is less noisy than standard alignment mode. | | |
| <i>PSI</i> | [PSI align] (PSI) : Pulse signal injection. Standard alignment mode by pulse signal injection. | | |
| <i>PSIO</i> | [PSIO align] (PSIO) : Pulse signal injection - Optimized. Standard optimized alignment mode by pulse signal injection. The phase-shift angle measurement time is reduced after the first run order or tune operation, even if the drive has been turned off. | | |
| <i>ND</i> | [No align] (ND) : No alignment | | |

(1) The parameter can also be accessed in the **[SETTINGS] (SEL -)** menu.



These parameters only appear if the corresponding function has been selected in another menu. When the parameters can also be accessed and adjusted from within the configuration menu for the corresponding function, their description is detailed in these menus, on the pages indicated, to aid programming.

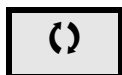

Parameter that can be modified during operation or when stopped.



To change the assignment of this parameter, press the ENT key for 2 s.

BRAKE LOGIC CONTROL

Used to control an electromagnetic brake by the drive, for horizontal and vertical hoisting applications, and for unbalanced machines.

Principle:

- Vertical hoisting movement:

Maintain motor torque in the driving load holding direction during brake opening and closing, in order to hold the load, start smoothly when the brake is released and stop smoothly when the brake is engaged.

- Horizontal movement:

Synchronize brake release with the build-up of torque during startup and brake engage at zero speed on stopping, to help to prevent jolting.

Recommended settings for brake logic control for a vertical hoisting application:

⚠ WARNING

LOSS OF CONTROL

- Check that the selected settings and configurations will not result in the dropping or loss of control of the load being lifted.
- Follow the recommendations below.

Failure to follow these instructions can result in death, serious injury, or equipment damage.

- **[Brake impulse] (b IP): [Yes] (YES)**. Ensure that the direction of rotation FW corresponds to lifting the load.
For applications in which the load being lowered is very different from the load being lifted, set **b IP = 2 Ibr** (for example, ascent always with a load and descent always without a load).
- Brake release current (**[Brake release I FW] (Ibr)** and **[Brake release I Rev] (Ird)**) if **[Brake impulse] (b IP) = 2 Ibr**: Adjust the brake release current to the rated current indicated on the motor. During testing, adjust the brake release current in order to hold the load smoothly.
- Acceleration time: For hoisting applications, it is advisable to set the acceleration ramps to more than 0.5 seconds. Ensure that the drive does not exceed the current limit.
The same recommendation applies for deceleration.
Reminder: For a hoisting movement, a braking resistor should be used.
- **[Brake Release time] (brt)**: Set according to the type of brake. It is the time required for the mechanical brake to release.
- **[Brake release frequency] (brf)**, in open-loop mode only: Leave in **[Auto] (AUTD)**, adjust if necessary.
- **[Brake engage frequency] (ben)**: Leave in **[Auto] (AUTD)**, adjust if necessary.
- **[Brake engage time] (bet)**: Set according to the type of brake. It is the time required for the mechanical brake to engage.

Recommended settings for brake logic control for a horizontal hoisting application:

- **[Brake impulse] (b IP)**: No
- Brake release current (**Ibr**): Set to 0.
- **[Brake Release time] (brt)**: Set according to the type of brake. It is the time required for the mechanical brake to release.
- **[Brake engage frequency] (ben)**, in open-loop mode only: Leave in **[Auto] (AUTD)**, adjust if necessary.
- **[Brake engage time] (bet)**: Set according to the type of brake. It is the time required for the mechanical brake to engage.

Brake logic control, horizontal movement in open-loop mode

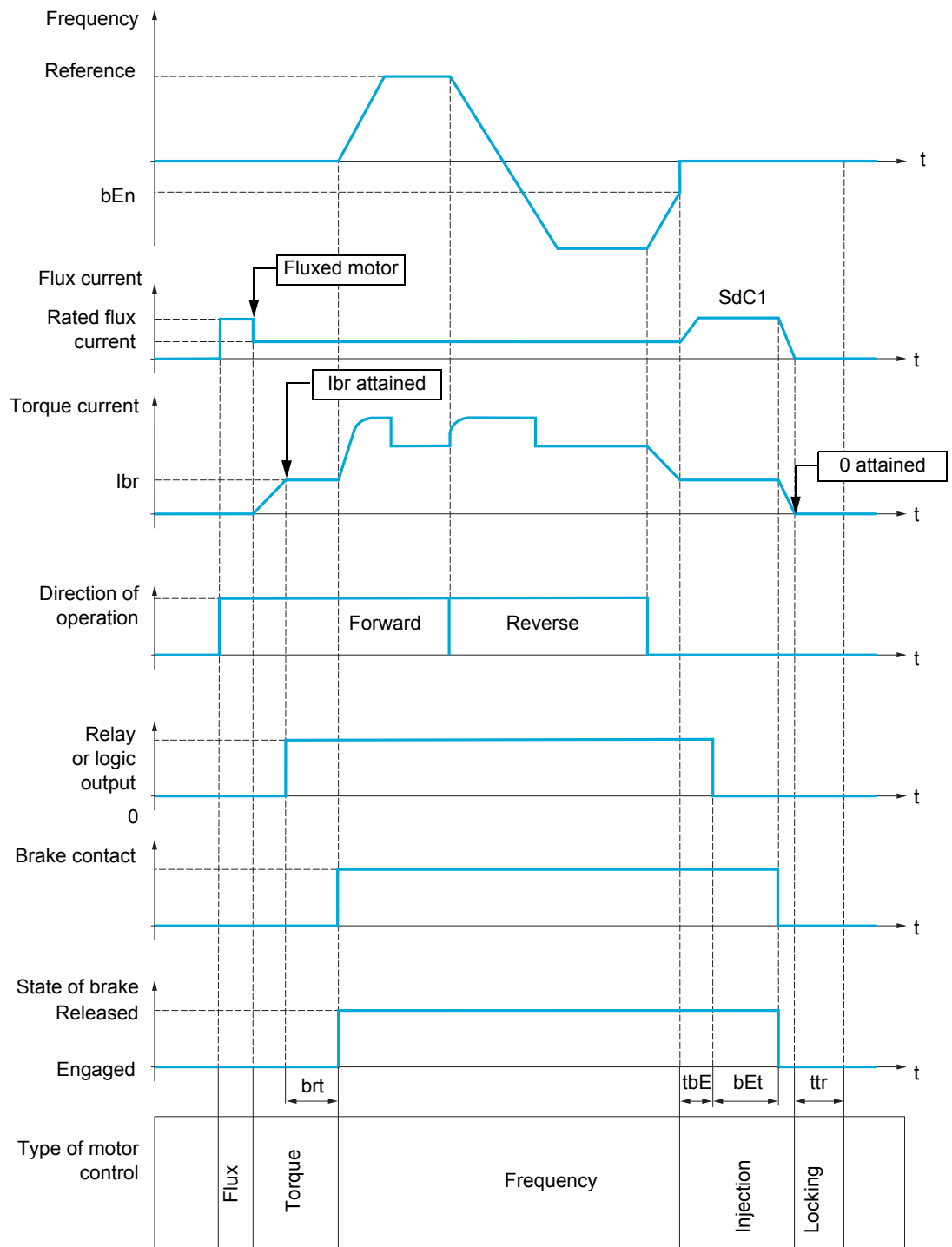

Key:

- (b E n): [Brake engage freq]
- (b E t): [Brake engage time]
- (b r t): [Brake Release time]
- (I b r): [Brake release I FW]
- (S d C 1): [Auto DC inj. level 1]
- (t b E): [Brake engage delay]
- (t t r): [Time to restart]

Brake logic control, vertical movement in open-loop mode

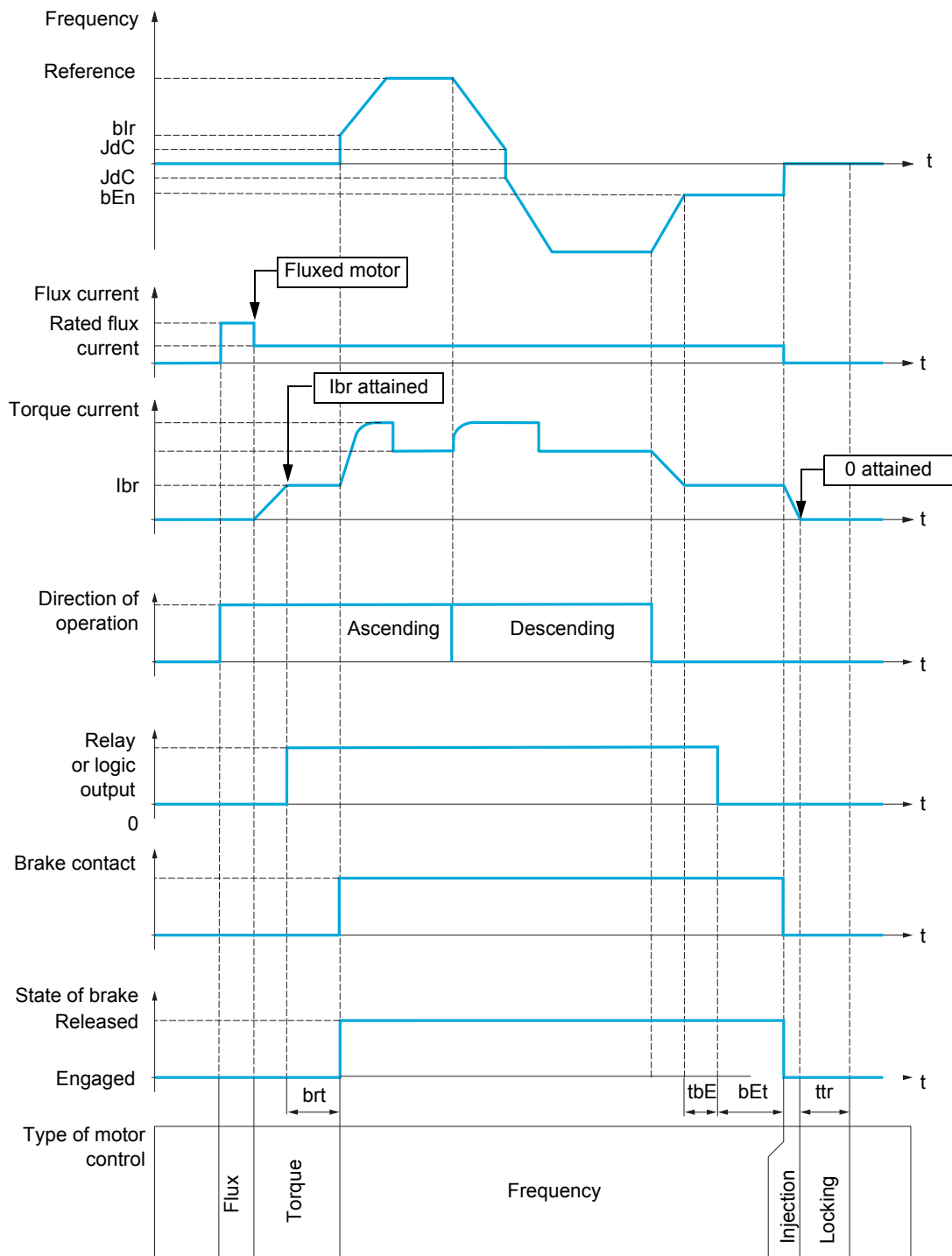

Key:

- ($b E n$): [Brake engage freq]
- ($b E t$): [Brake engage time]
- ($b I r$): [Brake release freq]
- ($b r t$): [Brake Release time]
- ($I b r$): [Brake release I FW]
- ($J d C$): [Jump at reversal]
- ($t b E$): [Brake engage delay]
- ($t t r$): [Time to restart]

| Code | Name / Description | Adjustment range | Factory setting |
|-------------------------------|---|------------------------------|---------------------------|
| <i>F U n -</i> | [APPLICATION FUNCT.] (continued) | | |
| <i>b L C -</i> | [BRAKE LOGIC CONTROL] Note: This function cannot be used with certain other functions. Follow the instructions on page 148. | | |
| <i>b L C</i> | [Brake assignment] Logic output or control relay. Note: If the brake is assigned, only a ramp stop is possible. Check the [Type of stop] (5 E E) page 158. Brake logic control can only be assigned if [Motor control type] (C E E) is not set to [Standard] (5 E d) , [V/F 5pts] (U F 5) , [V/F Quad.] (U F 9) or [Sync. mot] (5 Y n) . See Compatibility table page 150 to see the compatible functions. <i>n D</i> [No] (n D) : Function not assigned (in this case, none of the function parameters can be accessed) <i>r 2</i> [R2] (r 2) : Relay <i>L D I</i> [LO1] (L D I) : Logic output <i>d D I</i> [dO1] (d D I) : Analog output AO1 functioning as a logic output. Selection can be made if [AO1 assignment] (A D I) page 129 is set to [No] (n D) | | [No] (n D) |
| <i>b 5 E</i> ★ | [Movement type] <i>H D r</i> [Traveling] (H D r) : Resistive-load movement (translational motion of overhead crane, for example) Note: If [Motor control type] (C E E) is set to [Standard] (5 E d) or [V/F 5pts] (U F 5) , [Movement type] (b 5 E) is forced to [Traveling] (H D r) . <i>U E r</i> [Hoisting] (U E r) : Driving-load movement (hoisting winch, for example) Note: If [Weight sensor ass.] (P E 5) page 185 is not [No] (n D) , [Movement type] (b 5 E) is forced to [Hoisting] (U E r) . | | [Hoisting] (U E r) |
| <i>b C I</i> ★ | [Brake contact] If the brake has a monitoring contact (closed for released brake). <i>n D</i> [No] (n D) : Not assigned <i>L I I</i> [LI1] (L I I) : Logical input LI1 <i>...</i> [...] (. . .): See the assignment conditions on page 138 | | [No] (n D) |
| <i>b I P</i> ★ ⌚ | [Brake impulse] Brake impulse. This parameter can be accessed if [Weight sensor ass.] (P E 5) is set to [No] (n D) (see page 185). It is set to [Yes] (Y E 5) if [Movement type] (b 5 E) is set to [Hoisting] (U E r) . <i>n D</i> [No] (n D) : The motor torque is given in the required operating direction, at current [Brake release I FW] (I b r) <i>Y E 5</i> [Yes] (Y E 5) : The motor torque is in forward direction (check that this direction corresponds to ascending), at current [Brake release I FW] (I b r) <i>2 I b r</i> [2 IBR] (2 I b r) : The torque is in the required direction, at current [Brake release I FW] (I b r) for Forward and [Brake release I Rev] (I r d) for Reverse, for certain specific applications | | [Yes] (Y E 5) |
| <i>I b r</i> ★ ⌚ (1) | [Brake release I FW] Brake release current threshold for ascending or forward movement. This parameter can be accessed if [Weight sensor ass.] (P E 5) is set to [No] (n D) page 185. | 0 to 1.36 I _n (2) | 0 A |
| <i>I r d</i> ★ ⌚ (1) | [Brake release I Rev] Brake release current threshold for descending or reverse movement. This parameter can be accessed if [Brake impulse] (b I P) is set to [2 IBR] (2 I b r) . | 0 to 1.36 I _n (2) | 0 A |
| <i>b r t</i> ★ ⌚ (1) | [Brake Release time] Brake release time delay. | 0 to 5.00 s | 0 s |

Parameters described in this page can be accessed by:

DRI- > CONF > FULL > FUN- > BLC-

| Code | Name / Description | Adjustment range | Factory setting |
|---|--|---------------------------------------|-------------------------|
| <p><i>b l r</i></p> <p>★</p> <p>↻</p> <p>(1)</p> <p><i>A U E D</i></p> | <p>[Brake release freq]</p> <p>Brake release frequency threshold (initialization of acceleration ramp). This parameter can be accessed if [Movement type] (<i>b 5 t</i>) page 179 is set to [Hoisting] (<i>U E r</i>).</p> <p>[Auto] (A U E D): The drive takes a value equal to the rated slip of the motor, calculated using the drive parameters 0 to 10 Hz: Manual control.</p> | [Auto] (A U E D) to 10 Hz | [Auto] (A U E D) |
| <p><i>b E n</i></p> <p>★</p> <p>↻</p> <p>(1)</p> <p><i>A U E D</i></p> | <p>[Brake engage freq]</p> <p>Brake engage frequency threshold. Note: [Brake engage freq] (<i>b E n</i>) cannot be higher than [Low speed] (<i>L 5 P</i>).</p> <p>[Auto] (A U E D): The drive takes a value equal to the rated slip of the motor, calculated using the drive parameters 0 to 10 Hz: Manual control.</p> | [Auto] (A U E D) 0 to 10 Hz | [Auto] (A U E D) |
| <p><i>t b E</i></p> <p>★</p> <p>↻</p> <p>(1)</p> | <p>[Brake engage delay]</p> <p>Time delay before request to engage brake.</p> | 0 to 5.00 s | 0 s |
| <p>⚠ WARNING</p> <p>LOSS OF CONTROL Modify the Brake engage delay for horizontal movement only otherwise the control of the load can be lost. Failure to follow these instructions can result in death, serious injury, or equipment damage.</p> | | | |
| <p><i>b E t</i></p> <p>★</p> <p>↻</p> <p>(1)</p> | <p>[Brake engage time]</p> <p>Brake engage time (brake response time).</p> | 0 to 5.00 s | 0 s |
| <p><i>S d C I</i></p> <p>★</p> <p>↻</p> <p>(1)</p> | <p>[Auto DC inj. level 1]</p> <p>Level of standstill DC injection current. Note: This parameter can be accessed if [Movement type] (<i>b 5 t</i>) page 179 is set to [Traveling] (<i>H D r</i>).</p> | 0 to 1.2 In (2) | 0.7 In (2) |
| <p>CAUTION</p> <p>RISK OF DAMAGE TO THE MOTOR Check that the motor will withstand this current without overheating. Failure to follow these instructions can result in equipment damage.</p> | | | |
| <p><i>b E d</i></p> <p>★</p> <p>↻</p> <p><i>n D</i></p> <p><i>Y E 5</i></p> | <p>[Engage at reversal]</p> <p>Can be used to select whether or not the brake engages on transition to zero speed when the operating direction is reversed.</p> <p>[No] (n D): The brake does not engage [Yes] (Y E 5): The brake engages</p> | | [No] (n D) |

Parameters described in this page can be accessed by: DRI- > CONF > FULL > FUN- > BLC-

| Code | Name / Description | Adjustment range | Factory setting |
|--|--|----------------------------------|-------------------------|
| <p>J d C</p> <p>★</p> <p>(1)</p> <p>R U E D</p> <p>-</p> | <p>[Jump at reversal]</p> <p>This parameter can be accessed if [Movement type] (b 5 E) page 179 is set to [Hoisting] (U E r).</p> <p>[Auto] (R U E D): The drive takes a value equal to the rated slip of the motor, calculated using the drive parameters 0 to 10 Hz: Manual control</p> <p>When the reference direction is reversed, this parameter can be used to avoid loss of torque (and consequential release of load) on transition to zero speed. Parameter is not applicable if [Engage at reversal] (b E d) = [Yes] (Y E S).</p> | [Auto] (R U E D) to 10 Hz | [Auto] (R U E D) |
| <p>t t r</p> <p>★</p> <p>(1)</p> | <p>[Time to restart]</p> <p>Time between the end of a brake engage sequence and the start of a brake release sequence.</p> | 0.00 to 15.00 s | 0 s |

- (1) The parameter can also be accessed in the **[SETTINGS] (S E E -)** menu.
- (2) In corresponds to the rated drive current indicated in the Installation manual and on the drive nameplate.

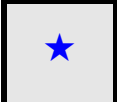
 These parameters only appear if the corresponding function has been selected in another menu. When the parameters can also be accessed and adjusted from within the configuration menu for the corresponding function, their description is detailed in these menus, on the pages indicated, to aid programming.

 Parameter that can be modified during operation or when stopped.

Parameters described in this page can be accessed by:

DRI- > CONF > FULL > FUN- > BLC-

Brake control logic expert parameters

Following parameters for brake logic sequence are accessible in expert mode only.

| Code | Name / Description | Adjustment range | Factory setting |
|------------------|--|------------------|-----------------|
| <i>brH0</i> ★ | <p>[BRH b0]</p> <p>Selection of the brake restart sequence if a run command is repeated while the brake is engaging.</p> <p> <input type="checkbox"/> [0] (D): The engage/release sequence is completely executed <input type="checkbox"/> [1] (I): The brake is released immediately </p> <p>A run command may be requested during the brake engagement phase. Whether or not the brake release sequence is executed depends on the value selected for [BRH b0] (brH0).</p> | | 0 |
| <i>brH1</i> ★ | <p>[BRH b1]</p> <p>Deactivation of the brake contact in steady state fault.</p> <p> <input type="checkbox"/> [0] (D): The brake contact in steady state fault is active (fault state if the contact is open during operation). The [Brake feedback] (brF) brake contact fault is monitored in all operating phases. <input type="checkbox"/> [1] (I): The brake contact in steady state fault is inactive. The [Brake feedback] (brF) brake contact fault is only monitored during the brake release and engage phases. </p> <p>Note: If a run command is requested during the "ttr" phase, the complete brake control sequence is initialized.</p> | | 0 |

Parameters described in this page can be accessed by: DRI- > CONF > FULL > FUN- > BLC-

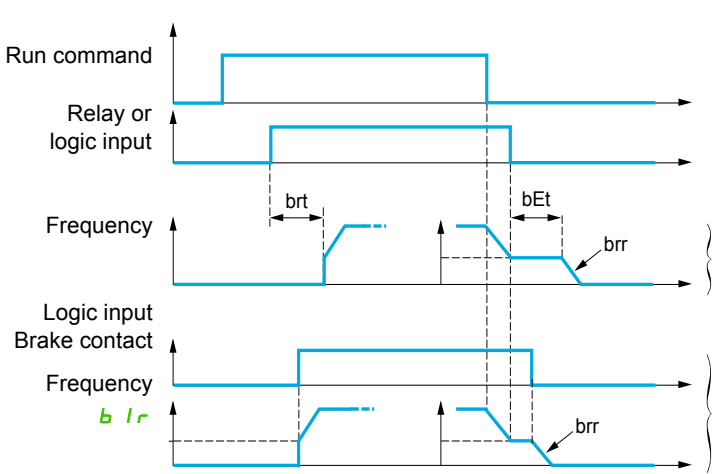
| Code | Name / Description | Adjustment range | Factory setting |
|--|---|------------------|-----------------|
| <p><i>brH2</i></p> <p>★</p> <p>0 (0): The brake contact is not taken into account</p> <p>1 (1): The brake contact is taken into account</p> <p>If a logic input is assigned to the brake contact:</p> <ul style="list-style-type: none"> - [BRH b2] (brH2) = 0: During the brake release sequence, the reference is enabled at the end of the time [Brake Release time] (brt). During the brake engage sequence, the current changes to 0 according to the ramp [Current ramp time] (brr) at the end of the [Brake engage time] (bEt). - [BRH b2] (brH2) = 1: When the brake is released, the reference is enabled when the logic input changes to 1. When the brake is engaged, the current changes to 0 according to the ramp [Current ramp time] (brr) when the logic input changes to 0.  | <p>[BRH b2]</p> | | 0 |
| <p><i>brr</i></p> <p>★</p> <p>(↻)</p> | <p>[Current ramp time]</p> <p>Torque current ramp time (increase and decrease) for a current variation equal to [Brake release I FW] (lbr).</p> | 0 to 5.00 s | 0 s |

★ These parameters only appear if the corresponding function has been selected in another menu. When the parameters can also be accessed and adjusted from within the configuration menu for the corresponding function, their description is detailed in these menus, on the pages indicated, to aid programming.

(↻) Parameter that can be modified during operation or when stopped.

EXTERNAL WEIGHT MEASUREMENT

Load measurement

This function uses the information supplied by a weight sensor to adapt the current **[Brake release I FW] (Ibr)** of the **[BRAKE LOGIC CONTROL] (b L C -)** function. The signal from the weight sensor can be assigned to an analog input (usually a 4 - 20 mA signal) or to the pulse-in input, according to the type of weight sensor.

Example: Measurement of the total weight of a hoisting winch and its load

The current **[Brake release I FW] (Ibr)** is adapted in accordance with the curve below.

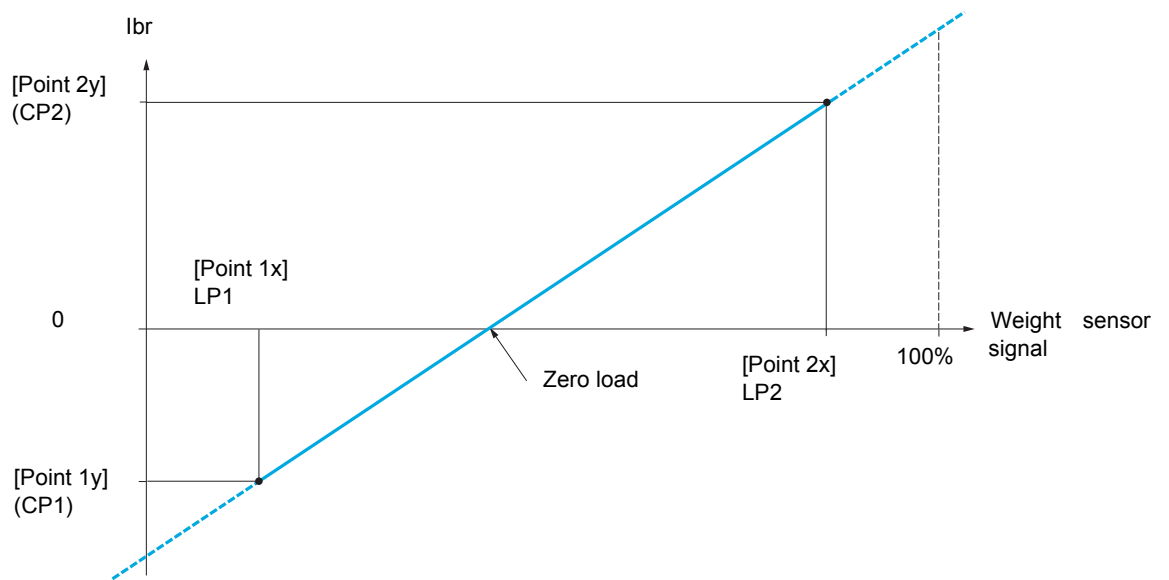

| Code | Name / Description | Adjustment range | Factory setting |
|--|--|-------------------------|-------------------|
| F U n - | [APPLICATION FUNCT.] (continued) | | |
| E L n - | [EXTERNAL WEIGHT MEAS.] | | |
| P E 5 | [Weight sensor ass.] | | [No] (n 0) |
| <div style="border: 1px solid black; padding: 10px; margin: 10px auto; width: 80%;"> <p style="text-align: center; font-weight: bold; font-size: 1.2em;">⚠ WARNING</p> <p>LOSS OF CONTROL Check that [Point 1 X] (L P 1), [Point 2x] (L P 2), [Point 1Y] (C P 1) and [Point 2Y] (C P 2) are correctly set to avoid loss of control of the load being lifted. Failure to follow these instructions can result in death, serious injury, or equipment damage.</p> </div> | | | |
| This parameter can be configured if [BRAKE LOGIC CONTROL] (b L C -) page 179 is not set to [No] (n 0) . | | | |
| n 0 | [No] (n 0) : Not assigned | | |
| A 1 1 | [AI1] (A 1 1) : Analog input A1 | | |
| A 1 2 | [AI2] (A 1 2) : Analog input A2 | | |
| A 1 3 | [AI3] (A 1 3) : Analog input A3 | | |
| P 1 | [RP] (P 1) : Pulse input | | |
| A 1 U 1 | [AI virtual 1] (A 1 U 1) : Virtual analog input 1 with the jog dial | | |
| A 1 U 2 | [AI virtual 2] (A 1 U 2) : Virtual analog input 2 by the communication bus | | |
| O A 0 1 | [OA01] (O A 0 1) : Function blocks: Analog Output 01 | | |
| ... | ... | | |
| O A 1 0 | [OA10] (O A 1 0) : Function blocks: Analog Output 10 | | |
| L P 1 | [Point 1 X] | 0 to LP2-0.01% | 0% |
| ★ | 0 to 99.99% of signal on assigned input. [Point 1x] (L P 1) must be less than [Point 2x] (L P 2) . This parameter can be accessed if [Weight sensor ass.] (P E 5) is assigned. | | |
| C P 1 | [Point 1Y] | -1.36 In to 1.36 In (1) | -In (1) |
| ★ | Current corresponding to load [Point 1 X] (L P 1) , in A. This parameter can be accessed if [Weight sensor ass.] (P E 5) is assigned. | | |
| L P 2 | [Point 2X] | LP1+0.01% to 100% | 50% |
| ★ | 0.01 to 100% of signal on assigned input. [Point 2x] (L P 2) must be greater than [Point 1x] (L P 1) . This parameter can be accessed if [Weight sensor ass.] (P E 5) is assigned. | | |
| C P 2 | [Point 2Y] | -1.36 In to 1.36 In (1) | 0 A |
| ★ | Current corresponding to load [Point 2x] (L P 2) , in A. This parameter can be accessed if [Weight sensor ass.] (P E 5) is assigned. | | |
| l b r A | [lbr 4-20 mA loss] | 0 to 1.36 In (1) | 0 |
| ★ | Brake release current in the event of the loss of the weight sensor information. This parameter can be accessed if the weight sensor is assigned to an analog current input and the 4-20 mA loss is deactivated. Recommended settings: Rated motor current for a hoisting application. | | |
| (↻) | | | |

(1) In corresponds to the rated drive current indicated in the Installation manual and on the drive nameplate.



These parameters only appear if the corresponding function has been selected in another menu. When the parameters can also be accessed and adjusted from within the configuration menu for the corresponding function, their description is detailed in these menus, on the pages indicated, to aid programming.

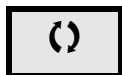

Parameter that can be modified during operation or when stopped.

HIGH SPEED HOISTING

This function can be used to optimize the cycle times for hoisting movements for zero or lightweight loads. It authorizes operation at "constant power" in order to reach a speed greater than the rated speed without exceeding the rated motor current.

The speed remains limited by the **[High speed] (HSP)** parameter page [75](#).

The function acts on the speed reference pedestal and not on the reference itself.

Principle:

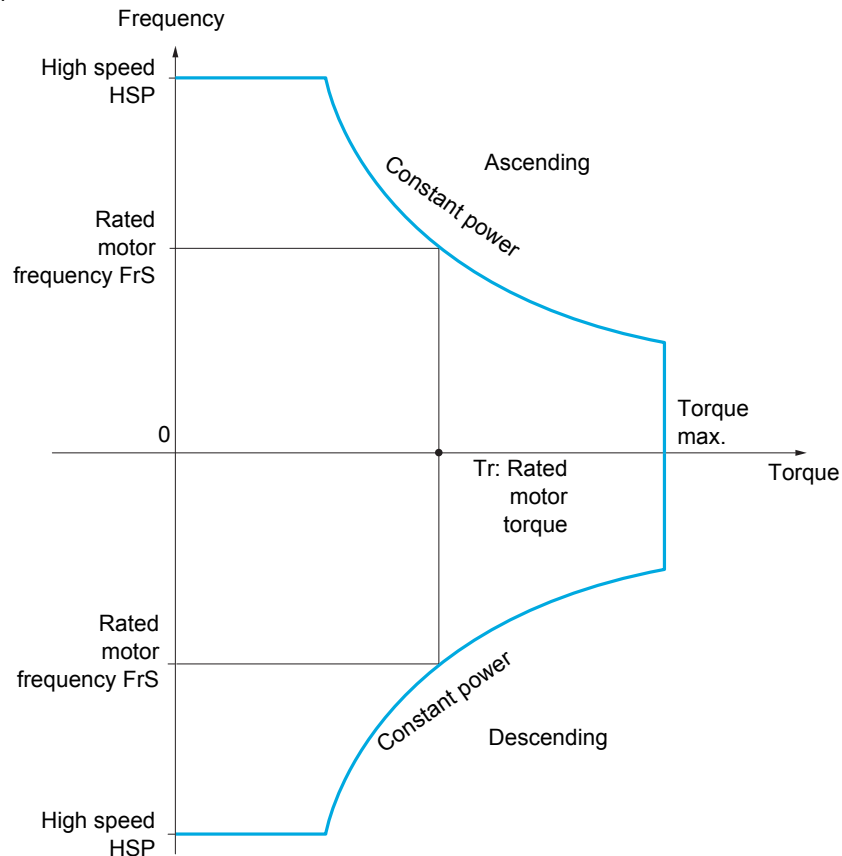

There are 2 possible operating modes:

- Speed reference mode: The maximum permissible speed is calculated by the drive during a speed step that is set so that the drive can measure the load.
- Current limitation mode: The maximum permissible speed is the speed that supports current limitation in motor mode, in the "ascending" direction only. For the "descending" direction, operation is in Speed reference mode.

Speed reference mode

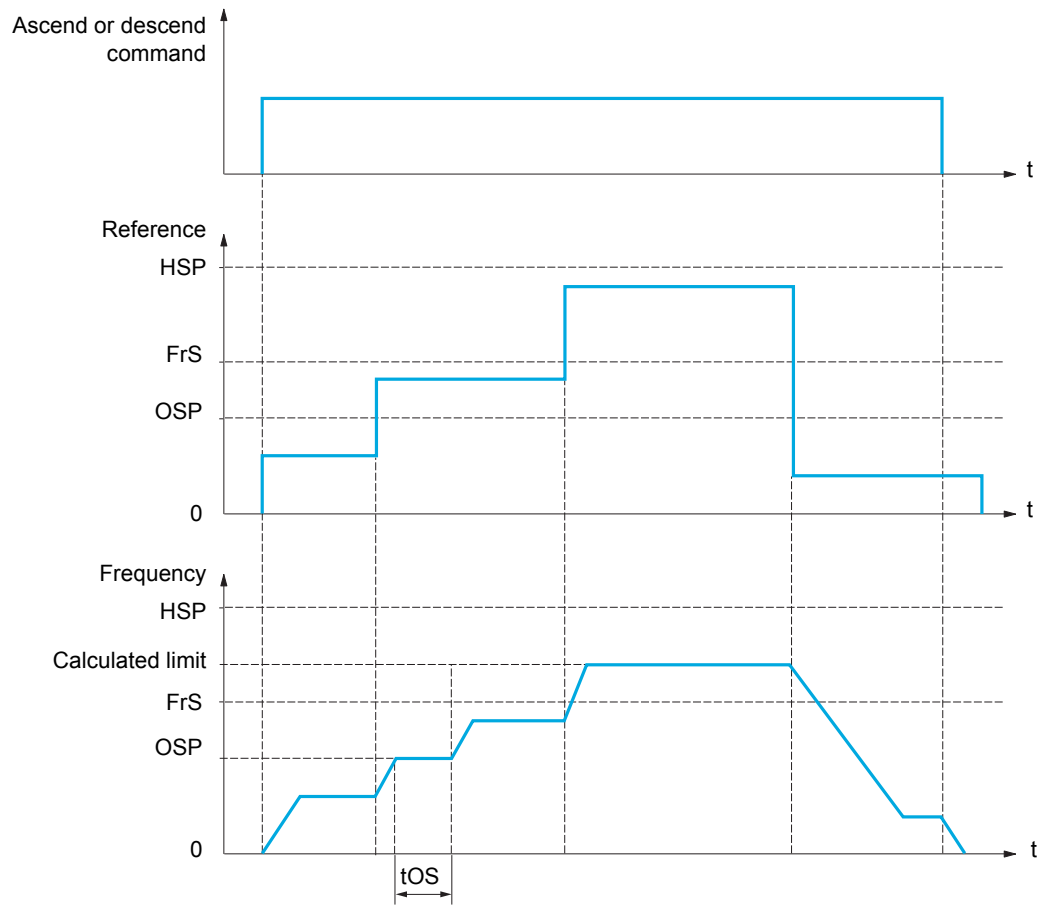

OSP: Adjustable speed step for load measurement

t_{OS} : Load measuring time

Two parameters are used to reduce the speed calculated by the drive, for ascending and descending.

Current limiting mode

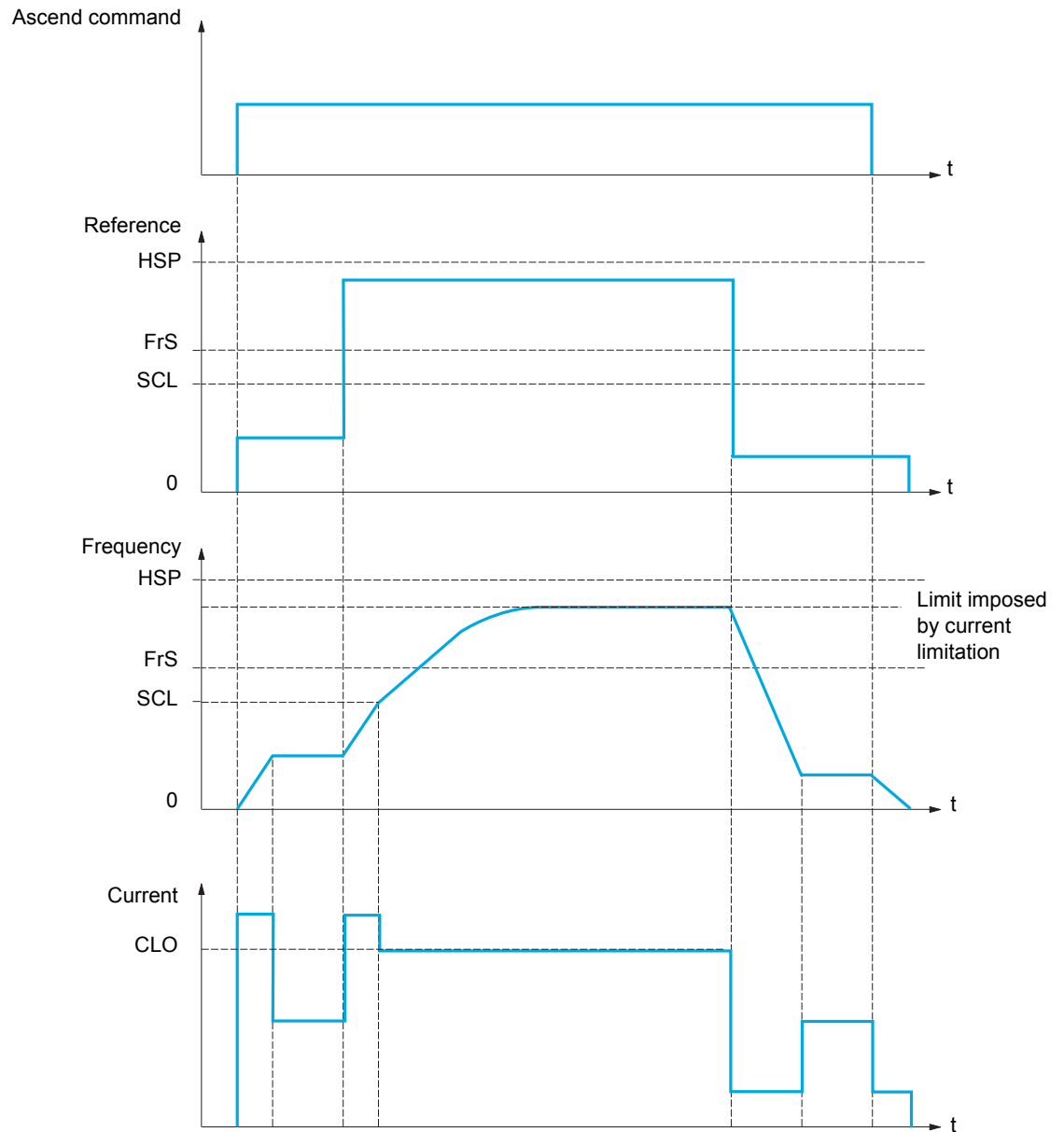

SCL: Adjustable speed threshold, above which current limitation is active

CLO: Current limitation for high-speed function

Note: The speed reached for a specific current will be lower in case of network undervoltage in comparison with nominal network voltage.

Rope slack

The Rope slack function can be used to help to prevent starting up at high speed when a load has been set down ready for lifting but the rope is still slack (as illustrated below).

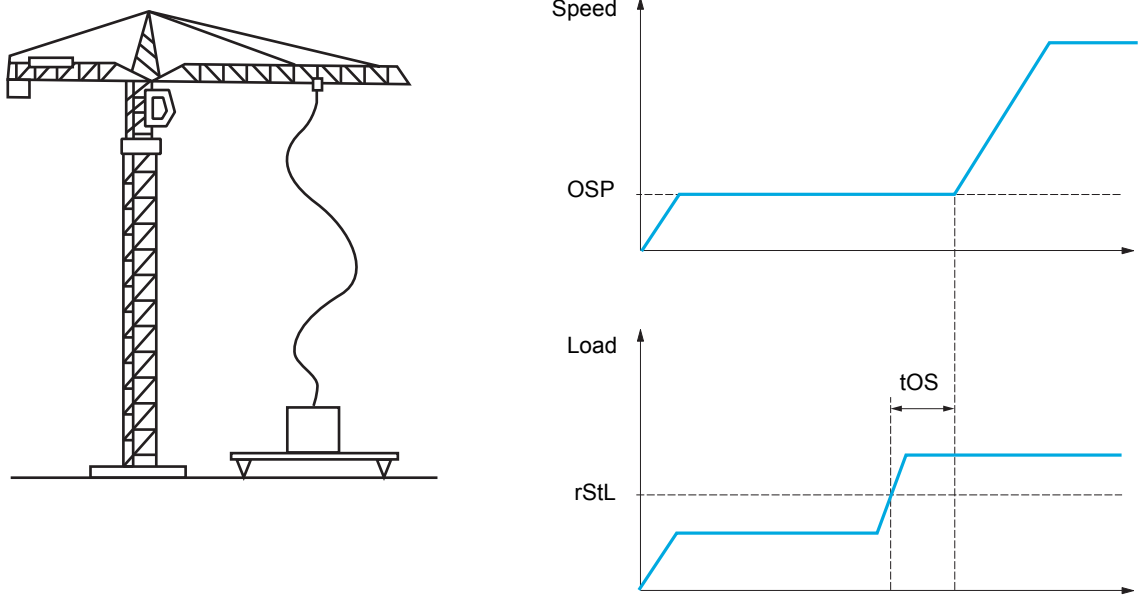

The speed step (OSP parameters) described on page [187](#) is used to measure the load. The effective measurement cycle will not be triggered until the load reaches the adjustable threshold **[Rope slack trq level] (rStL)**, which corresponds to the weight of the hook.

A logic output or a relay can be assigned to the indication of the rope slack state in the **[INPUTS / OUTPUTS CFG] (I - O -)** menu.

Parameters described in this page can be accessed by:

DRI- > CONF > FULL > FUN- > HSH-

| Code | Name / Description | Adjustment range | Factory setting |
|---|---|---|-------------------|
| F U n - | [APPLICATION FUNCT.] (continued) | | |
| H S H - | [HIGH SPEED HOISTING] Note: This function cannot be used with certain other functions. Follow the instructions on page 148. | | |
| H S D | [High speed hoisting] | | [No] (n D) |
| n D S S D C S D | [No] (n D): Function inactive [Speed ref] (S S D): Speed reference mode [I Limit] (C S D): Current limitation mode | | |
| C D F ★ (↻) | [Motor speed coeff.] Speed reduction coefficient calculated by the drive for Ascending direction. This parameter can be accessed if [High speed hoisting] (H S D) is set to [Speed ref] (S S D) . | 0 to 100% | 100% |
| C D r ★ (↻) | [Gen. speed coeff] Speed reduction coefficient calculated by the drive for Descending direction. This parameter can be accessed if [High speed hoisting] (H S D) is not set to [No] (n D) . | 0 to 100% | 50% |
| t D S ★ (↻) | [Load measuring tm.] Duration of speed step for measurement. This parameter can be accessed if [High speed hoisting] (H S D) is not set to [No] (n D) . | 0.1 s to 65 s | 0.5 s |
| D S P ★ (↻) | [Measurement spd] Speed stabilized for measurement. This parameter can be accessed if [High speed hoisting] (H S D) is not set to [No] (n D) . | 0 to [Rated motor freq.] (F r 5) | 40 Hz |
| C L D ★ (↻) | [High speed I Limit] Current limitation at high speed. This parameter can be accessed if [High speed hoisting] (H S D) is set to [I Limit] (C S D) . Note: If the setting is less than 0.25 In, the drive may lock in [Output Phase Loss] (D P L) fault mode if this has been enabled (see page 238). | 0 to 1.5 In (1) | In (1) |
| S C L ★ (↻) | [I Limit. frequency] Frequency threshold, above which the high-speed limitation current is active. This parameter can be accessed if [High speed hoisting] (H S D) is set to [I Limit] (C S D) . | 0 to 599 Hz according to rating | 40 Hz |
| r S d ★ n D d r I P E S | [Rope slack config.] Rope slack function. This parameter can be accessed if [High speed hoisting] (H S D) is not set to [No] (n D) . [No] (n D): Function inactive [Drive estim.] (d r I): Measurement of the load by estimating the torque generated by the drive [Ext. sensor] (P E S): Measurement of the load using a weight sensor, can only be assigned if [Weight sensor ass.] (P E S) page 185 is not [No] (n D) | | [No] (n D) |

Parameters described in this page can be accessed by:

DRI- > CONF > FULL > FUN- > HSH-

| Code | Name / Description | Adjustment range | Factory setting |
|---------------------|---|------------------|-----------------|
| r 5 t L ★ | [Rope slack trq level] Adjustment threshold corresponding to a load weighing slightly less than the hook when off-load, as a % of the rated load. This parameter can be accessed if [Rope slack trq level] (r 5 d) has been assigned. | 0 to 100% | 0% |

(1) In corresponds to the rated drive current indicated in the Installation manual and on the drive nameplate.



These parameters only appear if the corresponding function has been selected in another menu. When the parameters can also be accessed and adjusted from within the configuration menu for the corresponding function, their description is detailed in these menus, on the pages indicated, to aid programming.



Parameter that can be modified during operation or when stopped.

PID REGULATOR

Block diagram

The function is activated by assigning an analog input to the PID feedback (measurement).

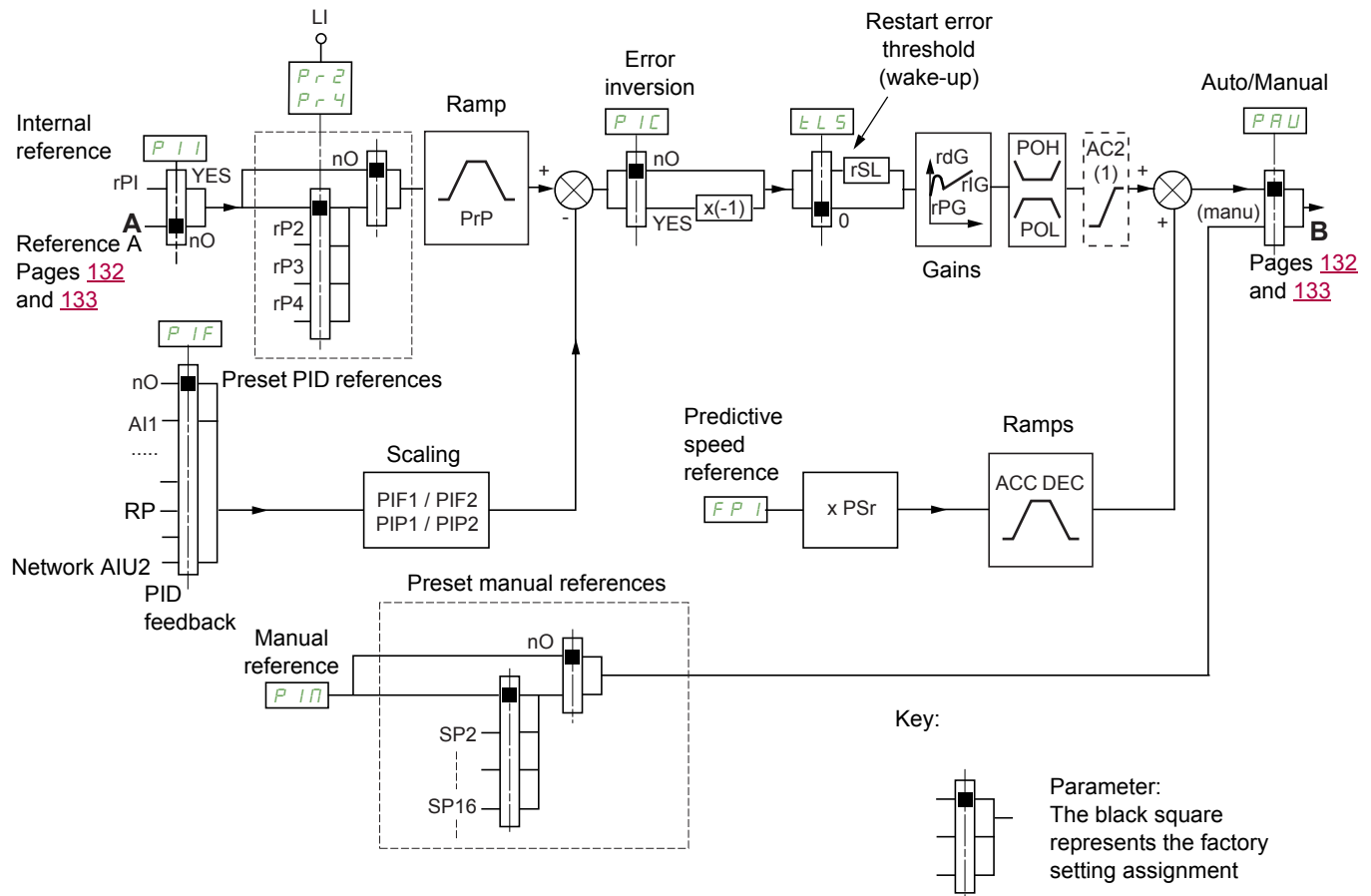

(1) Ramp AC2 is only active when the PID function starts up and during PID "wake-ups".

PID feedback:

The PID feedback must be assigned to one of the analog inputs AI1 to AI3, to the pulse input, according to whether any extension cards have been inserted.

PID reference:

The PID reference must be assigned to the following parameters: Preset references via logic inputs (*rP2*, *rP3*, *rP4*)

In accordance with the configuration of [Act. internal PID ref.] (*PII*) page 196:

Internal reference (*rPI*) or

Reference A ([Ref.1 channel] (*F r I*) or [Ref.1B channel] (*F r I b*), see page 139).

Combination table for preset PID references:

| LI (<i>Pr4</i>) | LI (<i>Pr2</i>) | <i>Pr2</i> = nO | Reference |
|-------------------|-------------------|-----------------|-----------|
| | | | rPI or A |
| 0 | 0 | | rPI or A |
| 0 | 1 | | rP2 |
| 1 | 0 | | rP3 |
| 1 | 1 | | rP4 |

A predictive speed reference can be used to initialize the speed on restarting the process.

Scaling of feedback and references:

- **[Min PID feedback] (P I F 1)**, **[Max PID feedback] (P I F 2)** parameters can be used to scale the PID feedback (sensor range). **This scale MUST be maintained for all other parameters.**
- **[Min PID reference] (P I P 1)**, **[Max PID reference] (P I P 2)** parameters can be used to scale the adjustment range, for example the reference. **The adjustment range MUST remain within the sensor range.**

The maximum value of the scaling parameters is 32,767. To facilitate installation, we recommend using values as close as possible to this maximum level, while retaining powers of 10 in relation to the actual values.

Example (see graph below): Adjustment of the volume in a tank, between 6 m³ and 15 m³.

- Sensor used 4-20 mA, 4.5 m³ for 4 mA and 20 m³ for 20 mA, with the result that **P I F 1** = 4,500 and **P I F 2** = 20,000.
- Adjustment range 6 to 15 m³, with the result that **P I P 1** = 6,000 (min. reference) and **P I P 2** = 15,000 (max. reference).
- Example references:
 - rP1 (internal reference) = 9,500
 - rP2 (preset reference) = 6,500
 - rP3 (preset reference) = 8,000
 - rP4 (preset reference) = 11,200

The **[3.4 DISPLAY CONFIG.]** menu can be used to customize the name of the unit displayed and its format.

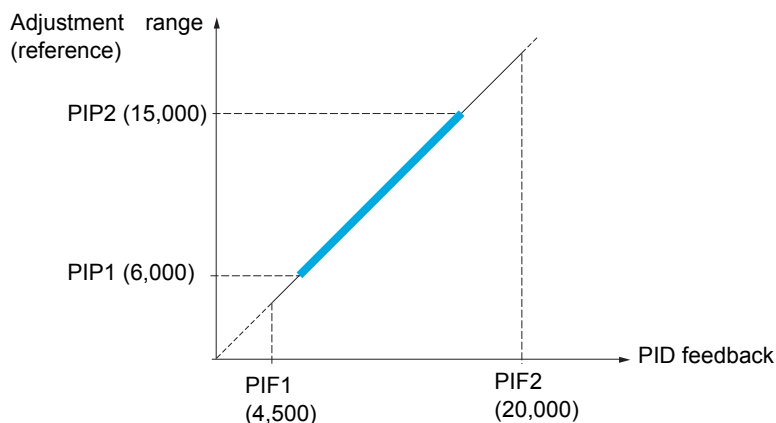

Other parameters:

- **[PID wake up thresh.] (r 5 L)** parameter: Can be used to set the PID error threshold, above which the PID regulator will be reactivated (wake-up) after a stop due to the max. time threshold being exceeded at low speed **[Low speed time out] (L L 5)**.
- Reversal of the direction of correction **[PID correct. reverse] (P I C)**: If **[PID correct. reverse] (P I C)** is set to **[No] (n 0)**, the speed of the motor will increase when the error is positive (for example: pressure control with a compressor). If **[PID correct. reverse] (P I C)** is set to **[Yes] (Y E 5)**, the speed of the motor will decrease when the error is positive (for example: temperature control using a cooling fan).
- The integral gain may be short-circuited by a logic input.
- An alarm on the PID feedback may be configured and indicated by a logic output.
- An alarm on the PID error may be configured and indicated by a logic output.

"Manual - Automatic" Operation with PID

This function combines the PID regulator, the preset speeds and a manual reference. Depending on the state of the logic input, the speed reference is given by the preset speeds or by a manual reference input via the PID function.

Manual reference [Manual reference] (P I N):

- Analog inputs AI1 to AI3
- Pulse input

Predictive speed reference [Speed ref. assign.] (F P I):

- [AI1] (A I 1): Analog input
- [AI2] (A I 2): Analog input
- [AI3] (A I 3): Analog input
- [RP] (P I): Pulse input
- [HMI] (L C C): Graphic display terminal or remote display terminal
- [Modbus] (M d b): Integrated Modbus
- [CANopen] (C A n): Integrated CANopen®
- [Com. card] (n E t): Communication card (if inserted)

Setting up the PID regulator

1. Configuration in PID mode.

See the diagram on page [192](#).

2. Perform a test in factory settings mode.

To optimize the drive, adjust [PID prop. gain] (r P G) or [PID integral gain] (r I G) gradually and independently, and observe the effect on the PID feedback in relation to the reference.

3. If the factory settings are unstable or the reference is incorrect.

- Perform a test with a speed reference in Manual mode (without PID regulator) and with the drive on load for the speed range of the system:
 - In steady state, the speed must be stable and comply with the reference, and the PID feedback signal must be stable.
 - In transient state, the speed must follow the ramp and stabilize quickly, and the PID feedback must follow the speed. If this is not the case, see the settings for the drive and/or sensor signal and wiring.
- Switch to PID mode.
- Set [Dec ramp adapt.] (b r A) to [No] (n O) (no auto-adaptation of the ramp).
- Set [PID ramp] (P r P) to the minimum permitted by the mechanism without triggering an [Overbraking] (O b F).
- Set the integral gain [PID integral gain] (r I G) to minimum.
- Leave the derivative gain [PID derivative gain] (r d G) at 0.
- Observe the PID feedback and the reference.
- Switch the drive ON/OFF a number of times or vary the load or reference rapidly a number of times.
- Set the proportional gain [PID prop. gain] (r P G) in order to ascertain the compromise between response time and stability in transient phases (slight overshoot and 1 to 2 oscillations before stabilizing).
- If the reference varies from the preset value in steady state, gradually increase the integral gain [PID integral gain] (r I G), reduce the proportional gain [PID prop. gain] (r P G) in the event of instability (pump applications), find a compromise between response time and static precision (see diagram).
- Lastly, the derivative gain may permit the overshoot to be reduced and the response time to be improved, although this will be more difficult to obtain a compromise in terms of stability, as it depends on 3 gains.
- Perform in-production tests over the whole reference range.

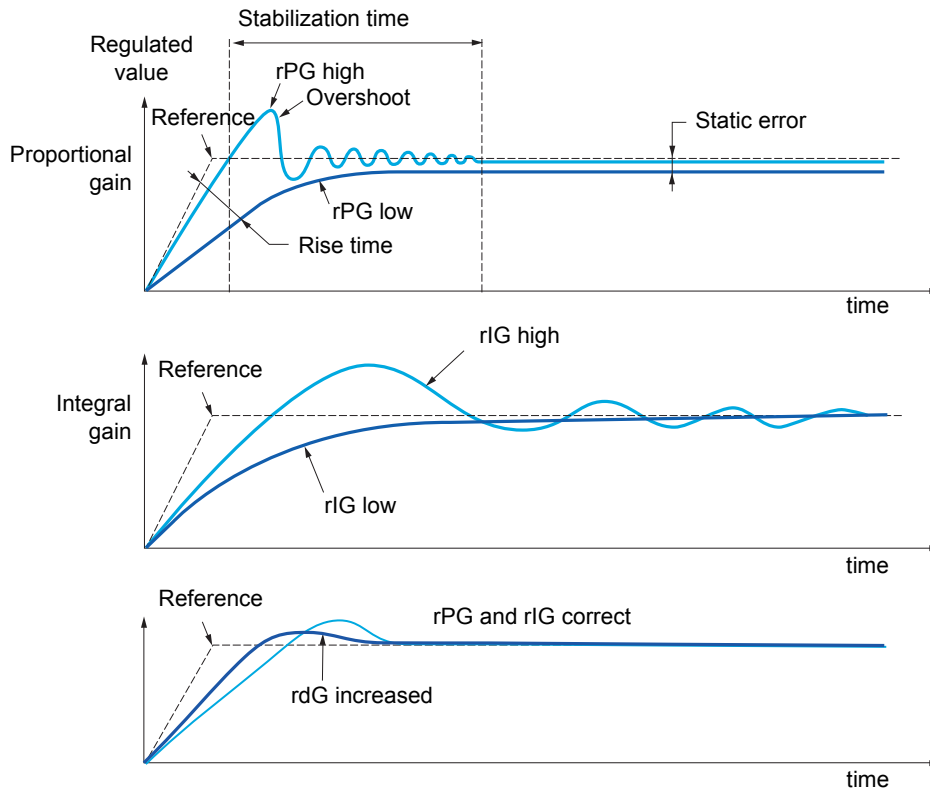

The oscillation frequency depends on the system kinematics.

| Parameter | Rise time | Overshoot | Stabilization time | Static error |
|-----------|-----------|-----------|--------------------|--------------|
| rPG ↗ | ↘ ↘ | ↗ | = | ↘ |
| rIG ↗ | ↘ | ↗ ↗ | ↗ | ↘ ↘ |
| rdG ↗ | = | ↘ | ↘ | = |

Parameters described in this page can be accessed by:

DRI- > CONF > FULL > FUN- > PID-

| Code | Name / Description | Adjustment range | Factory setting |
|----------------|---|---|-------------------|
| F U n - | [APPLICATION FUNCT.] (continued) | | |
| P I d - | [PID REGULATOR] Note: This function cannot be used with certain other functions. Follow the instructions on page 148. | | |
| P I F | [PID feedback ass.] | | [No] (n 0) |
| n 0 | [No] (n 0): Not assigned | | |
| A I 1 | [AI1] (A I 1): Analog input A1 | | |
| A I 2 | [AI2] (A I 2): Analog input A2 | | |
| A I 3 | [AI3] (A I 3): Analog input A3 | | |
| P I | [RP] (P I): Pulse input | | |
| A I U 1 | [AI virtual 1] (A I U 1): Virtual analog input 1 by the communication bus | | |
| A I U 2 | [AI virtual 2] (A I U 2): Virtual analog input 2 by the communication bus | | |
| O A 0 1 | [OA01] (O A 0 1): Function blocks: Analog Output 01 | | |
| ... | ... | | |
| O A 1 0 | [OA10] (O A 1 0): Function blocks: Analog Output 10 | | |
| A I C 2 | [AI2 net. channel] | | [No] (n 0) |
| ★ | This parameter can be accessed if [PID feedback ass.] (P I F) is set to [AI virtual 2] (A I U 2) . This parameter can also be accessed in the [INPUTS / OUTPUTS CFG] (I _ O -) menu. | | |
| n 0 | [No] (n 0): Not assigned | | |
| M o d b | [Modbus] (M o d b): Integrated Modbus | | |
| C A n | [CANopen] (C A n): Integrated CANopen® | | |
| n E t | [Com. card] (n E t): Communication card (if inserted) | | |
| P I F 1 | [Min PID feedback] | 0 to [Max PID feedback] (P I F 2) (2) | 100 |
| ★ | Value for minimum feedback. | | |
| ⌚ | | | |
| (1) | | | |
| P I F 2 | [Max PID feedback] | [Min PID feedback] (P I F 1) to 32,767 (2) | 1,000 |
| ★ | Value for maximum feedback. | | |
| ⌚ | | | |
| (1) | | | |
| P I P 1 | [Min PID reference] | [Min PID feedback] (P I F 1) to [Max PID reference] (P I P 2) (2) | 150 |
| ★ | Minimum process value. | | |
| ⌚ | | | |
| (1) | | | |
| P I P 2 | [Max PID reference] | [Min PID reference] (P I P 1) to [Max PID feedback] (P I F 2) (2) | 900 |
| ★ | Maximum process value. | | |
| ⌚ | | | |
| (1) | | | |
| P I I | [Act. internal PID ref.] | | [No] (n 0) |
| ★ | Internal PID regulator reference. | | |
| n 0 | [No] (n 0): The PID regulator reference is given by [Ref.1 channel] (F r 1) or [Ref.1B channel] (F r 1 b) with summing/subtraction/multiplication functions (see the diagram on page 192). | | |
| Y E 5 | [Yes] (Y E 5): The PID regulator reference is internal via [Internal PID ref.] (r P I) . | | |

Parameters described in this page can be accessed by:

DRI- > CONF > FULL > FUN- > PID-

| Code | Name / Description | Adjustment range | Factory setting |
|---|--|---|----------------------------|
| <p><i>r P I</i></p> <p>★</p> <p>()</p> | <p>[Internal PID ref.]</p> <p>Internal PID regulator reference. This parameter can also be accessed in the [1.2 MONITORING] (<i>Π Ω η -</i>) menu.</p> | <p>[Min PID reference] (<i>P I P 1</i>) to [Max PID reference] (<i>P I P 2</i>)</p> | 150 |
| <p><i>r P G</i></p> <p>★</p> <p>()</p> | <p>[PID prop. gain]</p> <p>Proportional gain.</p> | 0.01 to 100 | 1 |
| <p><i>r I G</i></p> <p>★</p> <p>()</p> | <p>[PID integral gain]</p> <p>Integral gain.</p> | 0.01 to 100 | 1 |
| <p><i>r d G</i></p> <p>★</p> <p>()</p> | <p>[PID derivative gain]</p> <p>Derivative gain.</p> | 0.00 to 100 | 0 |
| <p><i>P r P</i></p> <p>★</p> <p>()</p> <p>(1)</p> | <p>[PID ramp]</p> <p>PID acceleration/deceleration ramp, defined to go from [Min PID reference] (<i>P I P 1</i>) to [Max PID reference] (<i>P I P 2</i>) and vice versa.</p> | 0 to 99.9 s | 0 s |
| <p><i>P I C</i></p> <p>★</p> <p><i>η Ω</i> <i>Y E S</i></p> | <p>[PID correct. reverse]</p> <p>Reversal of the direction of correction [PID correct. reverse] (<i>P I C</i>): If [PID correct. reverse] (<i>P I C</i>) is set to [No] (<i>η Ω</i>), the speed of the motor will increase when the error is positive (example: pressure control with a compressor) If [PID correct. reverse] (<i>P I C</i>) is set to [Yes] (<i>Y E S</i>), the speed of the motor will decrease when the error is positive (example: temperature control using a cooling fan).</p> | | [No] (<i>η Ω</i>) |
| <p><i>P O L</i></p> <p>★</p> <p>()</p> <p>(1)</p> | <p>[Min PID output]</p> <p>Minimum value of regulator output in Hz.</p> | - 599 to 599 Hz | 0 Hz |
| <p><i>P O H</i></p> <p>★</p> <p>()</p> <p>(1)</p> | <p>[Max PID output]</p> <p>Maximum value of regulator output in Hz.</p> | 0 to 599 Hz | 60 Hz |
| <p><i>P A L</i></p> <p>★</p> <p>()</p> <p>(1)</p> | <p>[Min fbk alarm]</p> <p>Minimum monitoring threshold for regulator feedback.</p> | <p>[Min PID feedback] (<i>P I F 1</i>) to [Max PID feedback] (<i>P I F 2</i>) (2)</p> | 100 |

Parameters described in this page can be accessed by:

DRI- > CONF > FULL > FUN- > PID-

| Code | Name / Description | Adjustment range | Factory setting |
|---|--|---|------------------|
| PAH ★ (1) | [Max fbk alarm] Maximum monitoring threshold for regulator feedback. | [Min PID feedback] (P I F 1) to [Max PID feedback] (P I F 2) (2) | 1,000 |
| PEr ★ (1) | [PID error Alarm] Regulator error monitoring threshold. | 0 to 65,535 (2) | 100 |
| PIS ★ nD L I 1 ... | [PID integral reset] If the assigned input or bit is at 0, the function is inactive (the PID integral is enabled). If the assigned input or bit is at 1, the function is active (the PID integral is disabled). [No] (nD): Not assigned [L1] (L I 1): Logical input L11 [...] (. . .): See the assignment conditions on page 138 | | [No] (nD) |
| FPI ★ nD A I 1 A I 2 A I 3 L C C Mdb C R n n E t P I A I U 1 O A 0 1 ... O A 1 0 | [Speed ref. assign.] PID regulator predictive speed input. [No] (nD): Not assigned [A1] (A I 1): Analog input A1 [A2] (A I 2): Analog input A2 [A3] (A I 3): Analog input A3 [HMI] (L C C): Graphic display terminal or remote display terminal source [Modbus] (Mdb): Integrated Modbus [CANopen] (C R n): Integrated CANopen® [Com. card] (n E t): Communication option board source [RP] (P I): Pulse input [AI virtual 1] (A I U 1): Virtual analog input 1 with the jog dial [OA01] (O A 0 1): Function blocks: Analog Output 01 ... [OA10] (O A 1 0): Function blocks: Analog Output 10 | | [No] (nD) |
| PSr ★ (1) | [Speed input %] Multiplying coefficient for predictive speed input. This parameter cannot be accessed if [Speed ref. assign.] (F P I) is set to [No] (nD) . | 1 to 100% | 100% |
| PAU ★ nD L I 1 ... | [Auto/Manual assign.] If the assigned input or bit is at 0, the PID is active. If the assigned input or bit is at 1, manual operation is active. [No] (nD): Not assigned [L1] (L I 1): Logical input L11 [...] (. . .): See the assignment conditions on page 138 | | [No] (nD) |
| AC2 ★ (1) | [Acceleration 2] Time to accelerate from 0 to the [Rated motor freq.] (F r 5) . To have repeatability in ramps, the value of this parameter must be set according to the possibility of the application. Ramp AC2 is only active when the PID function starts up and during PID "wake-ups". | 0.00 to 6,000 s (3) | 5 s |

Parameters described in this page can be accessed by: DRI- > CONF > FULL > FUN- > PID-

| Code | Name / Description | Adjustment range | Factory setting |
|---|--|------------------|-------------------|
| <p>P I Π</p> <p>★</p> <p>n 0</p> <p>A I 1</p> <p>A I 2</p> <p>A I 3</p> <p>P I</p> <p>A I U 1</p> <p>O A 0 1</p> <p>...</p> <p>O A 1 0</p> | <p>[Manual reference]</p> <p>Manual speed input. This parameter can be accessed if [Auto/Manual assign.] (P A U) is not set to [No] (n 0). The preset speeds are active on the manual reference if they have been configured.</p> <p>[No] (n 0): Not assigned</p> <p>[AI1] (A I 1): Analog input A1</p> <p>[AI2] (A I 2): Analog input A2</p> <p>[AI3] (A I 3): Analog input A3</p> <p>[RP] (P I): Pulse input</p> <p>[AI virtual 1] (A I U 1): Virtual analog input 1 with the jog dial</p> <p>[OA01] (O A 0 1): Function blocks: Analog Output 01</p> <p>...</p> <p>[OA10] (O A 1 0): Function blocks: Analog Output 10</p> | | [No] (n 0) |
| <p>ε L 5</p> <p>(1)</p> | <p>[Low speed time out]</p> <p>Maximum operating time at [Low speed] (L 5 P) (see [Low speed] (L 5 P) page 75). Following operation at [Low speed] (L 5 P) for a defined period, a motor stop is requested automatically. The motor will restart if the reference is greater than [Low speed] (L 5 P) and if a run command is still present.</p> <p>Note: A value of 0 indicates an unlimited period of time.</p> <p>If [Low speed time out] (ε L 5) is not 0, [Type of stop] (5 ε ε) page 158 is forced to [Ramp stop] (r Π P) (only if a ramp stop can be configured).</p> | 0 to 999.9 s | 0 s |
| <p>r 5 L</p> <p>★</p> <p>⌚ 2 s</p> | <div style="background-color: black; color: white; text-align: center; padding: 5px;">⚠ DANGER</div> <p>UNINTENDED EQUIPMENT OPERATION</p> <p>Check that unintended restarts will not present any danger.</p> <p>Failure to follow these instructions will result in death or serious injury.</p> <p>If the "PID" and "Low speed operating time" [Low speed time out] (ε L 5) functions are configured at the same time, the PID regulator may attempt to set a speed lower than [Low speed] (L 5 P). This results in unsatisfactory operation, which consists of starting, operating at low speed then stopping, and so on... Parameter [PID wake up thresh.] (r 5 L) (restart error threshold) can be used to set a minimum PID error threshold for restarting after a stop at prolonged [Low speed] (L 5 P). [PID wake up thresh.] (r 5 L) is a percentage of the PID error (value depends on [Min PID feedback] (P I F 1) and [Max PID feedback] (P I F 2), see [Min PID feedback] (P I F 1) page 196). The function is inactive if [Low speed time out] (ε L 5) = 0 or if [PID wake up thresh.] (r 5 L) = 0.</p> | 0.0 to 100.0 | 0 |

- (1) The parameter can also be accessed in the **[SETTINGS] (5 E ε -)** menu.
- (2) If a graphic display terminal is not in use, values greater than 9,999 will be displayed on the 4-digit display with a period mark after the thousand digit, for example, 15.65 for 15,650.
- (3) Range 0.01 to 99.99 s or 0.1 to 999.9 s or 1 to 6,000 s according to **[Ramp increment] (I n r)** page 155.



These parameters only appear if the corresponding function has been selected in another menu. When the parameters can also be accessed and adjusted from within the configuration menu for the corresponding function, their description is detailed in these menus, on the pages indicated, to aid programming.

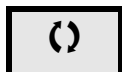

Parameter that can be modified during operation or when stopped.

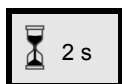



To change the assignment of this parameter, press the ENT key for 2 s.

Parameters described in this page can be accessed by:

DRI- > CONF > FULL > FUN- > PRI-

PID PRESET REFERENCES

| Code | Name / Description | Adjustment range | Factory setting |
|---|---|---|-------------------|
| F U n - | [APPLICATION FUNCT.] (continued) | | |
| P r 1 - | [PID PRESET REFERENCES] Function can be accessed if [PID feedback ass.] (P I F) page 196 is assigned. | | |
| P r 2 | [2 preset PID ref.] If the assigned input or bit is at 0, the function is inactive. If the assigned input or bit is at 1, the function is active. n 0 [No] (n 0): Not assigned L I 1 [L1] (L I 1): Logical input L11 ... [...]: See the assignment conditions on page 138 | | [No] (n 0) |
| P r 4 | [4 preset PID ref.] Check that [2 preset PID ref.] (P r 2) has been assigned before assigning this function. Identical to [2 preset PID ref.] (P r 2) page 198 . If the assigned input or bit is at 0, the function is inactive. If the assigned input or bit is at 1, the function is active. | | [No] (n 0) |
| r P 2 ★  (1) | [2 preset PID ref.] This parameter can be accessed if [Preset ref. PID 2] (P r 2) is assigned. | [Min PID reference] (P I P 1) to [Max PID reference] (P I P 2) (2) | 300 |
| r P 3 ★  (1) | [3 preset PID ref.] This parameter can be accessed if [Preset ref. PID 3] (P r 3) is assigned. | [Min PID reference] (P I P 1) to [Max PID reference] (P I P 2) (2) | 600 |
| r P 4 ★  (1) | [4 preset PID ref.] This parameter can be accessed if [Preset ref. PID 4] (P r 4) is assigned. | [Min PID reference] (P I P 1) to [Max PID reference] (P I P 2) (2) | 900 |

(1) The parameter can also be accessed in the **[SETTINGS] (S E E -)** menu.

(2) If a graphic display terminal is not in use, values greater than 9,999 will be displayed on the 4-digit display with a period mark after the thousand digit, for example, 15.65 for 15,650.

★ These parameters only appear if the corresponding function has been selected in another menu. When the parameters can also be accessed and adjusted from within the configuration menu for the corresponding function, their description is detailed in these menus, on the pages indicated, to aid programming.

 Parameter that can be modified during operation or when stopped.

TORQUE LIMITATION

There are two types of torque limitation:

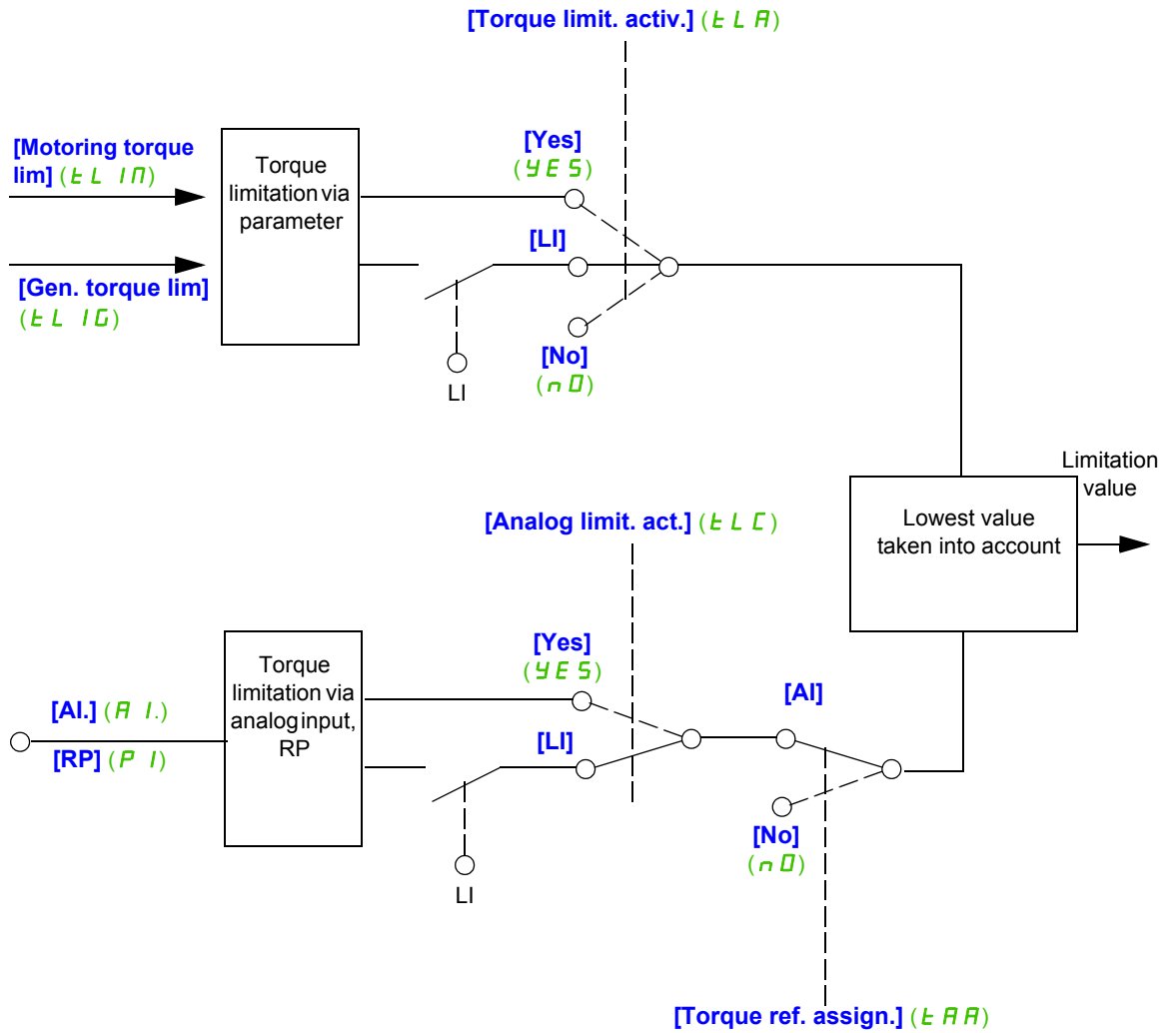

- With a value that is fixed by a parameter
- With a value that is set by an analog input (AI or pulse)

If both types are enabled, the lowest value is taken into account. The two types of limitation can be configured or switched remotely using a logic input or via the communication bus.



Parameters described in this page can be accessed by:

DRI- > CONF > FULL > FUN- > TOL-

| Code | Name / Description | Adjustment range | Factory setting |
|---|---|------------------|-------------------|
| F U n - | [APPLICATION FUNCT.] (continued) | | |
| É D L - | [TORQUE LIMITATION] | | |
| É L A | [Torque limit. activ.] If the assigned input or bit is at 0, the function is inactive. If the assigned input or bit is at 1, the function is active. n 0 [No] (n 0): Function inactive Y E 5 [Yes] (Y E 5): Function always active L I 1 [L1] (L I 1): Logical input LI1 ... [...] (...): See the assignment conditions on page 138 | | [No] (n 0) |
| I n É P ★ | [Torque increment] This parameter cannot be accessed if [Torque limit. activ.] (É L A) is set to [No] (n 0) . Selection of units for the [Motoring torque lim] (É L I n) and [Gen. torque lim] (É L I G) parameters. 0. 1 [0,1%] (0. 1): Unit 0.1% 1 [1%] (1): Unit 1% | | [1%] (1) |
| É L I n ★  (1) | [Motoring torque lim] This parameter cannot be accessed if [Torque limit. activ.] (É L A) is set to [No] (n 0) . Torque limitation in motor mode, as a % or in 0.1% increments of the rated torque in accordance with the [Torque increment] (I n É P) parameter. | 0 to 300% | 100% |
| É L I G ★  (1) | [Gen. torque lim] This parameter cannot be accessed if [Torque limit. activ.] (É L A) is set to [No] (n 0) . Torque limitation in generator mode, as a % or in 0.1% increments of the rated torque in accordance with the [Torque increment] (I n É P) parameter. | 0 to 300% | 100% |
| É A A | [Torque ref. assign.] If the function is assigned, the limitation varies between 0% and 300% of the rated torque on the basis of the 0% to 100% signal applied to the assigned input. Examples: 12 mA on a 4-20 mA input results in limitation to 150% of the rated torque. 2.5 V on a 10 V input results in 75% of the rated torque. n 0 [No] (n 0): Not assigned (function inactive) A I 1 [AI1] (A I 1): Analog input A I 2 [AI2] (A I 2): Analog input A I 3 [AI3] (A I 3): Analog input P I [RP] (P I): Pulse input A I U 1 [AI Virtual 1] (A I U 1): Virtual analog input 1 with the jog dial A I U 2 [AI Virtual 2] (A I U 2): Virtual input via communication bus, to be configured via [AI2 net. channel] (A I C 2) page 122 . O A 0 1 [OA01] (O A 0 1): Function blocks: Analog Output 01 ... O A 1 0 [OA10] (O A 1 0): Function blocks: Analog Output 10 | | [No] (n 0) |

| Code | Name / Description | Adjustment range | Factory setting |
|-------|--|------------------|----------------------|
| E L C | <p>[Analog limit. act.]</p> <p>This parameter cannot be accessed if [Torque limit. activ.] (E L A) is set to [No] (n 0).</p> <p>Identical to [Torque limit. activ.] (E L A) page 202.</p> <p>If the assigned input or bit is at 0: The limitation is specified by the [Motoring torque lim] (E L I 0) and [Gen. torque lim.] (E L I 1) parameters if [Torque limit. activ.] (E L A) is not [No] (n 0). No limitation if [Torque limit. activ.] (E L A) is set to [No] (n 0). If the assigned input or bit is at 1: The limitation depends on the input assigned by [Torque ref. assign.] (E A A). Note: If [Torque limitation] (E L A) and [Torque ref. assign.] (E A A) are enabled at the same time, the lowest value will be taken into account.</p> | | [Yes] (Y E 5) |

(1) The parameter can also be accessed in the **[SETTINGS]** (S E E -) menu.



These parameters only appear if the corresponding function has been selected in another menu. When the parameters can also be accessed and adjusted from within the configuration menu for the corresponding function, their description is detailed in these menus, on the pages indicated, to aid programming.



Parameter that can be modified during operation or when stopped.

Parameters described in this page can be accessed by:

DRI- > CONF > FULL > FUN- > CLI-

2ND CURRENT LIMITATION

| Code | Name / Description | Adjustment range | Factory setting |
|----------------|--|------------------|-------------------|
| F U n - | [APPLICATION FUNCT.] (continued) | | |
| C L 1 - | [2nd CURRENT LIMIT.] | | |
| L C 2 | <p>[Current limit 2]</p> <p>If the assigned input or bit is at 0, the first current limitation is active. If the assigned input or bit is at 1, the second current limitation is active.</p> <p>[No] (n 0)</p> <p>n 0 [No] (n 0): Function inactive L I 1 [L1] (L I 1): Logical input LI1 ... [...]: See the assignment conditions on page 138</p> | | [No] (n 0) |
| C L 2 | <p>[I Limit. 2 value]</p> | 0 to 1.5 In (1) | 1.5 In (1) |
| ★ () | <p>CAUTION</p> <p>RISK OF DAMAGE TO THE MOTOR AND THE DRIVE</p> <ul style="list-style-type: none"> • Check that the motor will withstand this current, particularly in the case of permanent magnet synchronous motors, which are susceptible to demagnetization. • Check that the profile mission complies with the derating curve given in the installation manual. <p>Failure to follow these instructions can result in equipment damage.</p> | | |
| | <p>Second current limitation. This parameter can be accessed if [Current limit 2] (L C 2) is not set to [No] (n 0). The adjustment range is limited to 1.5 In. Note: If the setting is less than 0.25 In, the drive may lock in [Output Phase Loss] (O P L) fault mode if this has been enabled (see [Output Phase Loss] (O P L) page 238). If it is less than the no-load motor current, the motor cannot run.</p> | | |
| C L 1 | <p>[Current limitation]</p> | 0 to 1.5 In (1) | 1.5 In (1) |
| ★ () | <p>CAUTION</p> <p>RISK OF DAMAGE TO THE MOTOR AND THE DRIVE</p> <ul style="list-style-type: none"> • Check that the motor will withstand this current, particularly in the case of permanent magnet synchronous motors, which are susceptible to demagnetization. • Check that the profile mission complies with the derating curve given in the installation manual. <p>Failure to follow these instructions can result in equipment damage.</p> | | |
| | <p>First current limitation. This parameter can be accessed if [Current limit 2] (L C 2) is not set to [No] (n 0). The adjustment range is limited to 1.5 In. Note: If the setting is less than 0.25 In, the drive may lock in [Output Phase Loss] (O P L) fault mode if this has been enabled (see [Output Phase Loss] (O P L) page 238). If it is less than the no-load motor current, the motor cannot run.</p> | | |

(1) In corresponds to the rated drive current indicated in the Installation manual and on the drive nameplate.



These parameters only appear if the corresponding function has been selected in another menu. When the parameters can also be accessed and adjusted from within the configuration menu for the corresponding function, their description is detailed in these menus, on the pages indicated, to aid programming.

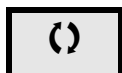

Parameter that can be modified during operation or when stopped.

LINE CONTACTOR COMMAND

The line contactor closes every time a run command (forward or reverse) is sent and opens after every stop, as soon as the drive is locked. For example, if the stop mode is stop on ramp, the contactor will open when the motor reaches zero speed.

Note: The drive control power supply must be provided via an external 24 V source.

Example circuit:

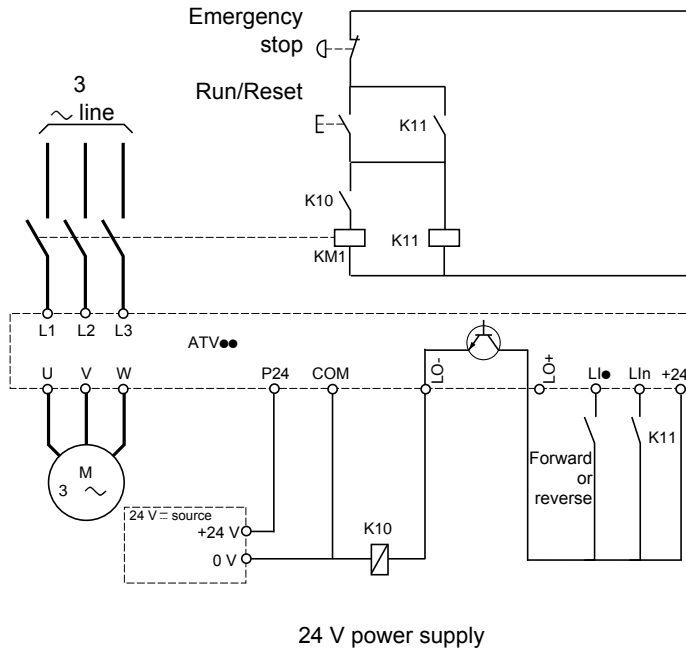

Note: The "Run/Reset" key must be pressed once the "Emergency stop" key has been released.

L1• = Run command **[Forward]** (F r d) or **[Reverse]** (r r 5)

LO-/LO+ = **[Line contactor ass.]** (L L C)

LIn = **[Drive lock]** (L E 5)

CAUTION

RISK OF DAMAGE TO THE MOTOR

This function can only be used for a small number of consecutive operations with a cycle time longer than 60 s (in order to avoid premature aging of the filter capacitor charging circuit).

Failure to follow these instructions can result in equipment damage.

Parameters described in this page can be accessed by:

DRI- > CONF > FULL > FUN- > LCC-

| Code | Name / Description | Adjustment range | Factory setting |
|----------------|---|------------------|-------------------|
| F U n - | [APPLICATION FUNCT.] (continued) | | |
| L L C - | [LINE CONTACTOR COMMAND] | | |
| L L C | [Line contactor ass.] Logic output or control relay. | | [No] (n 0) |
| n 0 | [No] (n 0) : Function not assigned (in this case, none of the function parameters can be accessed) | | |
| L 0 1 | [LO1] (L 0 1) : Logical output LO1 | | |
| r 2 | [R2] (r 2) : Relay r2 | | |
| d 0 1 | [d01] (d 0 1) : Analog output AO1 functioning as a logic output. Selection can be made if [AO1 assignment] (A 0 1) page 129 is set to [No] (n 0) | | |
| L E S | [Drive lock] | | [No] (n 0) |
| ★ | This parameter can be accessed if [Line contactor ass.] (L L C) is not set to [No] (n 0) . The drive locks when the assigned input or bit changes to 0. | | |
| n 0 | [No] (n 0) : Function inactive | | |
| L 1 1 | [LI1] (L 1 1) : Logical input LI1 | | |
| . . . | [...] (. . .): See the assignment conditions on page 138 | | |
| L C t | [Mains V. time out] | 5 to 999 s | 5 s |
| ★ | Monitoring time for closing of line contactor. If, once this time has elapsed, there is no voltage on the drive power circuit, the drive will lock with a [Line contactor] (L C F) detected fault. | | |



These parameters only appear if the corresponding function has been selected in another menu. When the parameters can also be accessed and adjusted from within the configuration menu for the corresponding function, their description is detailed in these menus, on the pages indicated, to aid programming.

OUTPUT CONTACTOR COMMAND

This allows the drive to control a contactor located between the drive and the motor. The request for the contactor to close is made when a run command is sent. The request for the contactor to open is made when there is no longer any current in the motor.

CAUTION

RISK OF DAMAGE TO THE MOTOR

If a DC injection braking function has been configured, it should not be left operating too long in stop mode, as the contactor only opens at the end of braking.

Failure to follow these instructions can result in equipment damage.

Output contactor feedback

The corresponding logic input should be at 1 when there is no run command and at 0 during operation.

In the event of an inconsistency, the drive trips in FCF2 if the output contactor fails to close (Llx at 1) and in FCF1 if it is stuck (Llx at 0).

The [\[Delay to motor run\] \(db5\)](#) parameter can be used to delay tripping in fault mode when a run command is sent and the [\[Delay to open cont.\] \(dR5\)](#) parameter delays the detected fault when a stop command is set.

Note: FCF2 (contactor failing to close) can be reset by the run command changing state from 1 to 0 (0 --> 1 --> 0 in 3-wire control).

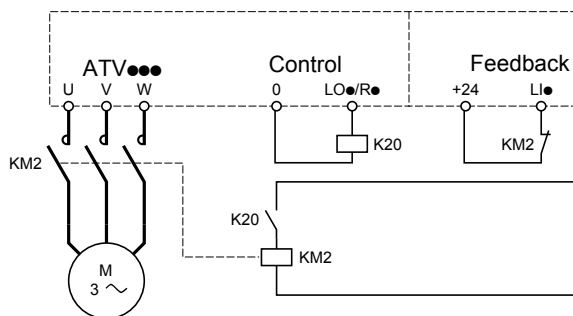

The [\[Out. contactor ass.\] \(DCC\)](#) and [\[Output contact. fdbk\] \(rCR\)](#) functions can be used individually or together.

Parameters described in this page can be accessed by:

DRI- > CONF > FULL > FUN- > OCC-

| Code | Name / Description | Adjustment range | Factory setting |
|----------------|--|------------------|-----------------|
| F U n - | [APPLICATION FUNCT.] (continued) | | |
| O C C - | [OUTPUT CONTACTOR CMD] | | |
| O C C | [Out. contactor ass.] Logic output or control relay. n 0 [No] (n 0): Function not assigned (in this case, none of the function parameters can be accessed) L O 1 [LO1] (L O 1): Logical output LO1 r 2 [R2] (r 2): Relay r2 d O 1 [dO1] (d O 1): Analog output AO1 functioning as a logic output. Selection can be made if [AO1 assignment] (A O 1) page 129 is set to [No] (n 0) | | [No] (n 0) |
| r C R | [Output contact. fdbk] The motor starts up when the assigned input or bit changes to 0. n 0 [No] (n 0): Function inactive L I 1 [LI1] (L I 1): Logical input LI1 . . . [...] (. . .): See the assignment conditions on page 138 | | [No] (n 0) |
| d b S | [Delay to motor run] Time delay for: ★ Motor control following the sending of a run command () Output contactor state monitoring, if the feedback is assigned. If the contactor fails to close at the end of the set time, the drive will lock in FCF2 mode. This parameter can be accessed if [Out. contactor ass.] (O C C) is assigned or if [Output contact. fdbk] (r C R) is assigned. The time delay must be greater than the closing time of the output contactor. | 0.05 to 60 s | 0.15 s |
| d R S | [Delay to open cont.] Time delay for output contactor opening command following motor stop. ★ This parameter can be accessed if [Output contact. fdbk] (r C R) is assigned. () The time delay must be greater than the opening time of the output contactor. If it is set to 0, the detected fault will not be monitored. If the contactor fails to open at the end of the set time, the drive will lock in FCF1 fault mode. | 0 to 5.00 s | 0.10 s |



These parameters only appear if the corresponding function has been selected in another menu. When the parameters can also be accessed and adjusted from within the configuration menu for the corresponding function, their description is detailed in these menus, on the pages indicated, to aid programming.

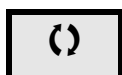

Parameter that can be modified during operation or when stopped.

POSITIONING BY SENSORS

This function is used for managing positioning using position sensors or limit switches linked to logic inputs or using control word bits:

- Slowing down
- Stopping

The action logic for the inputs and bits can be configured on a rising edge (change from 0 to 1) or a falling edge (change from 1 to 0). The example below has been configured on a rising edge:

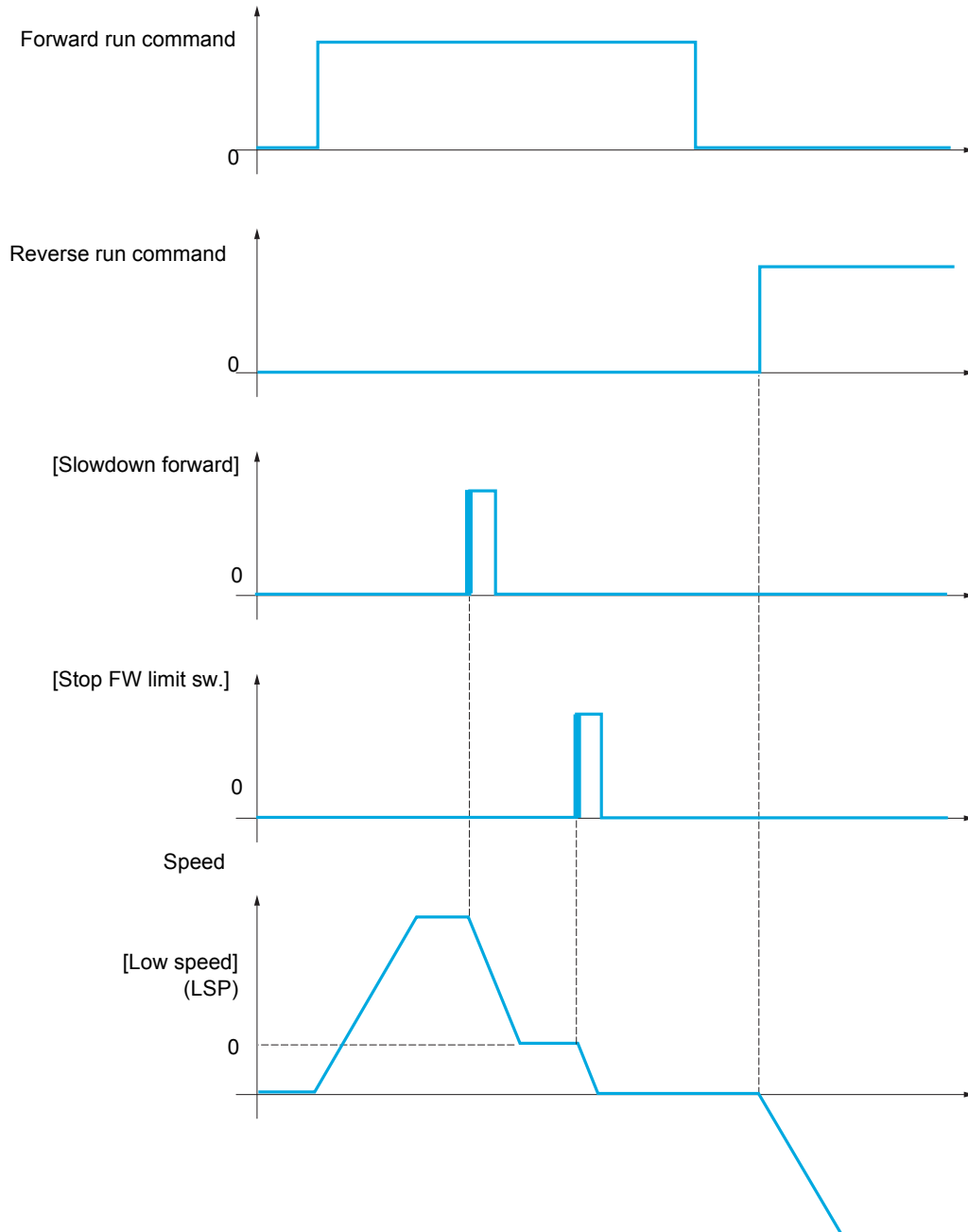

The slowdown mode and stop mode can be configured.

The operation is identical for both directions of operation. Slowdown and stopping operate according to the same logic, described below.

Example: Forward slowdown, on rising edge

- Forward slowdown takes place on a rising edge (change from 0 to 1) of the input or bit assigned to forward slowdown if this rising edge occurs in forward operation. The slowdown command is then memorized, even in the event of a power outage. Operation in the opposite direction is authorized at high speed. The slowdown command is deleted on a falling edge (change from 1 to 0) of the input or bit assigned to forward slowdown if this falling edge occurs in reverse operation.
- A bit or a logic input can be assigned to disable this function.
- Although forward slowdown is disabled while the disable input or bit is at 1, sensor changes continue to be monitored and saved.

Example: Positioning on a limit switch, on rising edge

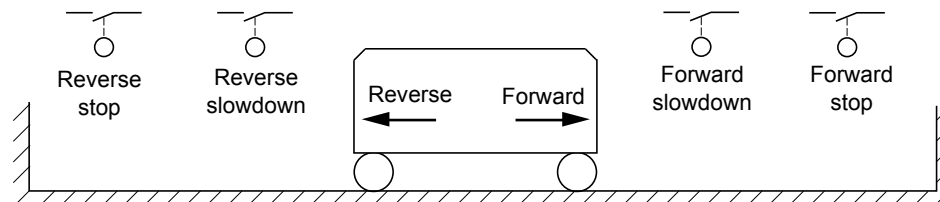

Operation with short cams:

| |
|---|
| ⚠ WARNING |
| <p>LOSS OF CONTROL When operating for the first time or after restoring the factory settings, the drive must initially be started outside the slowdown and stop zones in order to initialize the function. Failure to follow these instructions can result in death, serious injury, or equipment damage.</p> |

| |
|---|
| ⚠ WARNING |
| <p>LOSS OF CONTROL The current zone is memorized at power off. In case of manual modification of the system position, the drive must be started at the same position at the next power up of the drive. Failure to follow these instructions can result in death, serious injury, or equipment damage.</p> |

In this instance, when operating for the first time or after restoring the factory settings, the drive must initially be started outside the slowdown and stop zones in order to initialize the function.

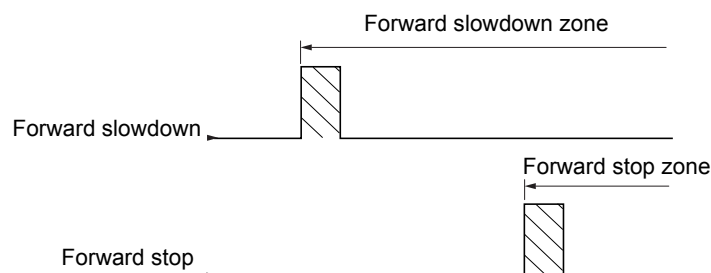

Operation with long cams:

In this instance, there is no restriction, which means that the function is initialized across the whole trajectory.

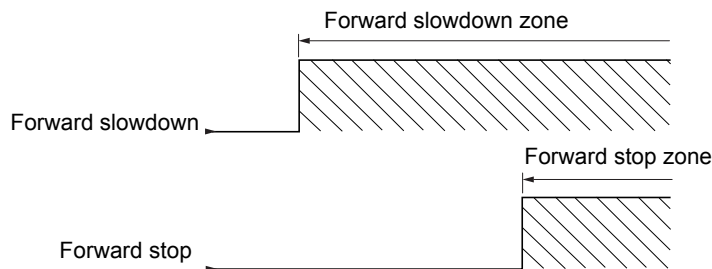

Stop at distance calculated after deceleration limit switch

This function can be used to control the stopping of the moving part automatically once a preset distance has been traveled after the slowdown limit switch.

On the basis of the rated linear speed and the speed estimated by the drive when the slowdown limit switch is tripped, the drive will induce the stop at the configured distance.

This function is useful in applications where one manual-reset overtravel limit switch is common to both directions. It will then only respond to help management if the distance is exceeded. The stop limit switch retains priority in respect of the function.

The **[Deceleration type] (d5F)** parameter can be configured to obtain either of the functions described below:

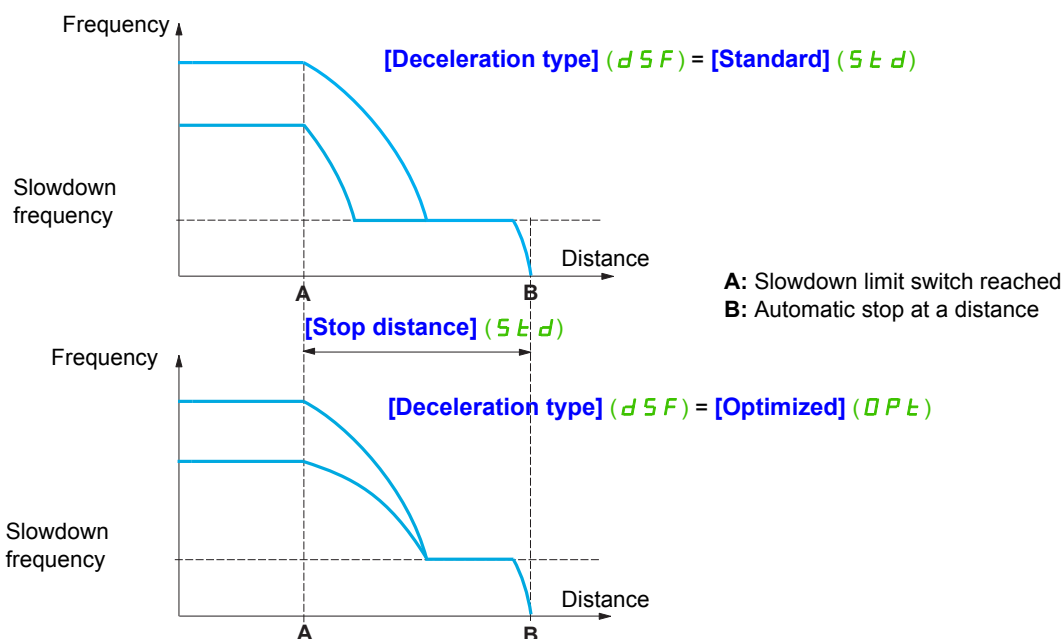

Note:

- If the deceleration ramp is modified while stopping at a distance is in progress, this distance will not be observed.
- If the direction is modified while stopping at a distance is in progress, this distance will not be observed.

| |
|--|
| ⚠ WARNING |
| <p>LOSS OF CONTROL</p> <ul style="list-style-type: none"> • Check that the parameters configured are consistent (in particular, you should check that the required distance is possible). • This function does not replace the stop limit switch, which remains necessary for safety reasons. <p>Failure to follow these instructions will result in death, serious injury, or equipment damage.</p> |

Parameters described in this page can be accessed by:

DRI- > CONF > FULL > FUN- > LPO-

| Code | Name / Description | Adjustment range | Factory setting |
|--|--|------------------|------------------------------------|
| <i>F U n -</i> | [APPLICATION FUNCT.] (continued) | | |
| <i>L P D -</i> | [POSITIONING BY SENSORS] Note: This function cannot be used with certain other functions. Follow the instructions on page 148. | | |
| <i>S A F</i> | [Stop FW limit sw.] Stop switch forward. | | [No] (<i>n D</i>) |
| <i>n D</i> <i>L I I</i> <i>...</i> | [No] (<i>n D</i>): Not assigned [LI1] (<i>L I I</i>): Logical input LI1 [...] (<i>...</i>): See the assignment conditions on page 138 | | |
| <i>S A r</i> | [Stop RV limit sw.] Stop switch reverse. Identical to [Stop FW limit sw.] (<i>S A F</i>) above. | | [No] (<i>n D</i>) |
| <i>S A L</i> | [Stop limit config.] | | [Active low] (<i>L D</i>) |
| ★ | <p style="text-align: center;">⚠ WARNING</p> <p>LOSS OF CONTROL If [Stop limit config.] (<i>S A L</i>) is set to [Active high] (<i>H I G</i>), the stop command will be activated on active signal (stop order will not be given if signal is not applied for any reason). Do not select [Active high] (<i>H I G</i>) unless you are sure that your signal will be present in any case. Failure to follow these instructions can result in death, serious injury, or equipment damage.</p> | | |
| | <p>Level stop switch activation. This parameter can be accessed if at least one limit switch or one stop sensor has been assigned. It defines the positive or negative logic of the bits or inputs assigned to the stop.</p> | | |
| <i>L D</i> <i>H I G</i> | <p>[Active low] (<i>L D</i>): Stop controlled on a falling edge (change from 1 to 0) of the assigned bits or inputs [Active high] (<i>H I G</i>): Stop controlled on a rising edge (change from 0 to 1) of the assigned bits or inputs</p> | | |
| <i>d A F</i> | [Slowdown forward] Slowdown attained forward. Identical to [Stop FW limit sw.] (<i>S A F</i>) above. | | [No] (<i>n D</i>) |
| <i>d A r</i> | [Slowdown reverse] Slowdown attained reverse. Identical to [Stop FW limit sw.] (<i>S A F</i>) above. | | [No] (<i>n D</i>) |
| <i>d A L</i> | [Slowdown limit cfg.] | | [Active low] (<i>L D</i>) |
| ★ | <p style="text-align: center;">CAUTION</p> <p>RISK OF DAMAGE TO THE EQUIPMENT If [Slowdown limit cfg.] (<i>d A L</i>) is set to [Active high] (<i>H I G</i>), the slowdown command will be activated on active signal (slowdown order will not be given if signal is not applied for any reason). Do not select [Active high] (<i>H I G</i>) unless you are sure that your signal will be present in any case. Failure to follow these instructions can result in equipment damage.</p> | | |
| | <p>This parameter can be accessed if at least one limit switch or one slowdown sensor has been assigned. It defines the positive or negative logic of the bits or inputs assigned to the slowdown.</p> | | |
| <i>L D</i> <i>H I G</i> | <p>[Active low] (<i>L D</i>): Slowdown controlled on a falling edge (change from 1 to 0) of the assigned bits or inputs [Active high] (<i>H I G</i>): Slowdown controlled on a rising edge (change from 0 to 1) of the assigned bits or inputs</p> | | |

Parameters described in this page can be accessed by: DRI- > CONF > FULL > FUN- > LPO-

| Code | Name / Description | Adjustment range | Factory setting |
|---------------------|---|------------------|--------------------------|
| CL5 ★ | [Disable limit sw.] <div style="border: 1px solid black; padding: 5px; text-align: center;">⚠ WARNING</div> LOSS OF CONTROL If [Disable limit sw.] (CL5) is set to an input and activated, the limit switch management will be inhibited. Check that this configuration will not endanger personnel or equipment in any way. Failure to follow these instructions can result in death, serious injury, or equipment damage. | | [No] (n0) |
| | This parameter can be accessed if at least one limit switch or one sensor has been assigned. The action of the limit switches is disabled when the assigned bit or input is at 1. If, at this time, the drive is stopped or being slowed down by limit switches, it will restart up to its speed reference. | | |
| n0 L11 ... | [No] (n0) : Function inactive [L11] (L11) : Logical input L11 [...] (. . .): See the assignment conditions on page 138 | | |
| PAS ★ | [Stop type] This parameter can be accessed if at least one limit switch or one sensor has been assigned. | | [Ramp stop] (rPP) |
| rPP F5t n5t | [Ramp stop] (rPP) : Follow ramp [Fast stop] (F5t) : Fast stop (ramp time reduced by [Ramp divider] (dCF) , see [Ramp divider] (dCF) page 81) [Freewheel] (n5t) : Freewheel stop | | |
| d5F ★ | [Deceleration type] This parameter can be accessed if at least one limit switch or one sensor has been assigned. | | [Standard] (5td) |
| 5td OPt | [Standard] (5td) : Uses the [Deceleration] (dEC) or [Deceleration 2] (dE2) ramp (depending on which has been enabled) [Optimized] (OPt) : The ramp time is calculated on the basis of the actual speed when the slowdown contact switches, in order to limit the operating time at low speed (optimization of the cycle time: the slowdown time is constant regardless of the initial speed). | | |
| 5td ★ | [Stop distance] This parameter can be accessed if at least one limit switch or one sensor has been assigned. Activation and adjustment of the "Stop at distance calculated after the slowdown limit switch" function. | | [No] (n0) |
| n0 - | [No] (n0) : Function inactive (the next two parameters will, therefore, be inaccessible) 0.01 to 10.00 : Stop distance range in meters | | |
| nL5 ★ | [Rated linear speed] This parameter can be accessed if at least one limit switch or one sensor has been assigned and [Stop distance] (5td) is not set to [No] (n0) . Rated linear speed in meters/second. | 0.20 to 5.00 m/s | 1.00 m/s |
| SFd ★ | [Stop corrector] This parameter can be accessed if at least one limit switch or one sensor has been assigned and [Stop distance] (5td) is not set to [No] (n0) . Scaling factor applied to the stop distance to compensate, for example, a non-linear ramp. | 50 to 200% | 100% |

★ These parameters only appear if the corresponding function has been selected in another menu. When the parameters can also be accessed and adjusted from within the configuration menu for the corresponding function, their description is detailed in these menus, on the pages indicated, to aid programming.

PARAMETER SET SWITCHING

A set of 1 to 15 parameters from the **[SETTINGS] (5 E E -)** menu on page 77 can be selected and 2 or 3 different values assigned. These 2 or 3 sets of values can then be switched using 1 or 2 logic inputs or control word bits. This switching can be performed during operation (motor running).

It can also be controlled on the basis of 1 or 2 frequency thresholds, whereby each threshold acts as a logic input (0 = threshold not reached, 1 = threshold reached).

| | Values 1 | Values 2 | Values 3 |
|--|--------------|--------------|--------------|
| Parameter 1 | Parameter 1 | Parameter 1 | Parameter 1 |
| Parameter 2 | Parameter 2 | Parameter 2 | Parameter 2 |
| Parameter 3 | Parameter 3 | Parameter 3 | Parameter 3 |
| Parameter 4 | Parameter 4 | Parameter 4 | Parameter 4 |
| Parameter 5 | Parameter 5 | Parameter 5 | Parameter 5 |
| Parameter 6 | Parameter 6 | Parameter 6 | Parameter 6 |
| Parameter 7 | Parameter 7 | Parameter 7 | Parameter 7 |
| Parameter 8 | Parameter 8 | Parameter 8 | Parameter 8 |
| Parameter 9 | Parameter 9 | Parameter 9 | Parameter 9 |
| Parameter 10 | Parameter 10 | Parameter 10 | Parameter 10 |
| Parameter 11 | Parameter 11 | Parameter 11 | Parameter 11 |
| Parameter 12 | Parameter 12 | Parameter 12 | Parameter 12 |
| Parameter 13 | Parameter 13 | Parameter 13 | Parameter 13 |
| Parameter 14 | Parameter 14 | Parameter 14 | Parameter 14 |
| Parameter 15 | Parameter 15 | Parameter 15 | Parameter 15 |
| Input LI or bit or frequency threshold 2 values | 0 | 1 | 0 or 1 |
| Input LI or bit or frequency threshold 3 values | 0 | 0 | 1 |

Note: Do not modify the parameters in the **[SETTINGS] (5 E E -)** menu, because any modifications made in this menu (**[SETTINGS] (5 E E -)**) will be lost on the next power-up. The parameters can be adjusted during operation in the **[PARAM. SET SWITCHING] (P L P -)** menu, on the active configuration.

Note: Parameter set switching cannot be configured from the integrated display terminal.

Parameters can only be adjusted on the integrated display terminal if the function has been configured previously via the graphic display terminal, by PC Software or via the bus or communication network. If the function has not been configured, the **[PARAM. SET SWITCHING] (P L P -)** menu and the **[SET 1] (P 5 1 -)**, **[SET 2] (P 5 2 -)**, **[SET 3] (P 5 3 -)** submenus will not appear.

| Code | Name / Description | Adjustment range | Factory setting | | | | | | | | | | | | | | | | | | | | | | | | | | | | | | | | | | | | | | | | | | | | | | | | | | | | | | | | |
|---------------------|---|------------------|---------------------|---------------------|------|----------|-------|----------------|-------------------------------------|-------|--------------------------|----------------|--------------------------|--------|-------------------------------------|----------------|--|--------|--|------------------|--|---------|--|------------------|--|---------|--|------------------|--|-------|--|------|--|-------|--|-----|------|---------|-------|--------------|--|--|--|--------|--|--|--|-----------|--|-------------|--|----|--|----|--|-------|--|--|--|
| F U n - | [APPLICATION FUNCT.] (continued) | | | | | | | | | | | | | | | | | | | | | | | | | | | | | | | | | | | | | | | | | | | | | | | | | | | | | | | | | | |
| Π L P - | [PARAM. SET SWITCHING] | | | | | | | | | | | | | | | | | | | | | | | | | | | | | | | | | | | | | | | | | | | | | | | | | | | | | | | | | | |
| C H R 1 | <p>[2 parameter sets]</p> <p>Switching 2 parameter sets.</p> <p>n D [No] (n D): Not assigned F t A [Freq. Th.att.] (F t A): Switching via [Freq. threshold] (F t d) page 234 F 2 A [Freq. Th. 2 att.] (F 2 A): Switching via [Freq. threshold 2] (F 2 d) page 234 L I 1 [LI1] (L I 1): Logical input LI1 [...] (. . .): See the assignment conditions on page 138</p> | | [No] (n D) | | | | | | | | | | | | | | | | | | | | | | | | | | | | | | | | | | | | | | | | | | | | | | | | | | | | | | | | |
| C H R 2 | <p>[3 parameter sets]</p> <p>Identical to [2 parameter sets] (C H R 1) page 215.</p> <p>Switching 3 parameter sets. Note: In order to obtain 3 parameter sets, [2 parameter sets] (C H R 1) must also be configured.</p> | | [No] (n D) | | | | | | | | | | | | | | | | | | | | | | | | | | | | | | | | | | | | | | | | | | | | | | | | | | | | | | | | |
| S P S | <p>[PARAMETER SELECTION]</p> <p>This parameter can only be accessed on the graphic display terminal if [2 parameter sets] (C H R 1) is not set to [No] (n D). Making an entry in this parameter opens a window containing all the adjustment parameters that can be accessed.</p> <p>Select 1 to 15 parameters using ENT (a ✓ then appears next to the parameter). Parameter(s) can also be deselected using ENT.</p> <p>Example:</p> <table border="1" style="margin-left: 20px;"> <thead> <tr> <th colspan="2">PARAMETER SELECTION</th> </tr> <tr> <th colspan="2">SETTINGS</th> </tr> </thead> <tbody> <tr> <td>Ramp increment</td> <td style="text-align: right;"><input checked="" type="checkbox"/></td> </tr> <tr> <td>-----</td> <td style="text-align: right;"><input type="checkbox"/></td> </tr> <tr> <td>-----</td> <td style="text-align: right;"><input type="checkbox"/></td> </tr> <tr> <td>-----</td> <td style="text-align: right;"><input checked="" type="checkbox"/></td> </tr> </tbody> </table> | | | PARAMETER SELECTION | | SETTINGS | | Ramp increment | <input checked="" type="checkbox"/> | ----- | <input type="checkbox"/> | ----- | <input type="checkbox"/> | ----- | <input checked="" type="checkbox"/> | | | | | | | | | | | | | | | | | | | | | | | | | | | | | | | | | | | | | | | | | | | | |
| PARAMETER SELECTION | | | | | | | | | | | | | | | | | | | | | | | | | | | | | | | | | | | | | | | | | | | | | | | | | | | | | | | | | | | |
| SETTINGS | | | | | | | | | | | | | | | | | | | | | | | | | | | | | | | | | | | | | | | | | | | | | | | | | | | | | | | | | | | |
| Ramp increment | <input checked="" type="checkbox"/> | | | | | | | | | | | | | | | | | | | | | | | | | | | | | | | | | | | | | | | | | | | | | | | | | | | | | | | | | | |
| ----- | <input type="checkbox"/> | | | | | | | | | | | | | | | | | | | | | | | | | | | | | | | | | | | | | | | | | | | | | | | | | | | | | | | | | | |
| ----- | <input type="checkbox"/> | | | | | | | | | | | | | | | | | | | | | | | | | | | | | | | | | | | | | | | | | | | | | | | | | | | | | | | | | | |
| ----- | <input checked="" type="checkbox"/> | | | | | | | | | | | | | | | | | | | | | | | | | | | | | | | | | | | | | | | | | | | | | | | | | | | | | | | | | | |
| Π L P - | [PARAM. SET SWITCHING] (continued) | | | | | | | | | | | | | | | | | | | | | | | | | | | | | | | | | | | | | | | | | | | | | | | | | | | | | | | | | | |
| P S 1 - | <p>[SET 1]</p> <p>This parameter can be accessed if at least 1 parameter has been selected in [PARAMETER SELECTION]. Making an entry in this parameter opens a settings window containing the selected parameters in the order in which they were selected.</p> <p>With the graphic display terminal:</p> <div style="display: flex; align-items: center; margin-left: 20px;"> <table border="1" style="margin-right: 10px;"> <thead> <tr> <th>RDY</th> <th>Term</th> <th>+0.0 Hz</th> <th>0.0 A</th> </tr> </thead> <tbody> <tr> <td colspan="4" style="text-align: center;">SET1</td> </tr> <tr> <td>Acceleration :</td> <td></td> <td style="text-align: right;">9.51 s</td> <td>ENT</td> </tr> <tr> <td>Deceleration :</td> <td></td> <td style="text-align: right;">9.67 s</td> <td></td> </tr> <tr> <td>Acceleration 2 :</td> <td></td> <td style="text-align: right;">12.58 s</td> <td></td> </tr> <tr> <td>Deceleration 2 :</td> <td></td> <td style="text-align: right;">13.45 s</td> <td></td> </tr> <tr> <td>Begin Acc round:</td> <td></td> <td style="text-align: right;">2.3 s</td> <td></td> </tr> <tr> <td>Code</td> <td></td> <td style="text-align: right;">Quick</td> <td></td> </tr> </tbody> </table> <table border="1" style="margin-left: 20px;"> <thead> <tr> <th>RDY</th> <th>Term</th> <th>+0.0 Hz</th> <th>0.0 A</th> </tr> </thead> <tbody> <tr> <td colspan="4" style="text-align: center;">Acceleration</td> </tr> <tr> <td colspan="4" style="text-align: center; font-size: 2em;">9.51 s</td> </tr> <tr> <td colspan="2">Min = 0.1</td> <td colspan="2">Max = 999.9</td> </tr> <tr> <td colspan="2" style="text-align: center;"><<</td> <td colspan="2" style="text-align: center;">>></td> </tr> <tr> <td colspan="4" style="text-align: right;">Quick</td> </tr> </tbody> </table> </div> <p>With the integrated display terminal: Proceed as in the Settings menu using the parameters that appear.</p> | | | RDY | Term | +0.0 Hz | 0.0 A | SET1 | | | | Acceleration : | | 9.51 s | ENT | Deceleration : | | 9.67 s | | Acceleration 2 : | | 12.58 s | | Deceleration 2 : | | 13.45 s | | Begin Acc round: | | 2.3 s | | Code | | Quick | | RDY | Term | +0.0 Hz | 0.0 A | Acceleration | | | | 9.51 s | | | | Min = 0.1 | | Max = 999.9 | | << | | >> | | Quick | | | |
| RDY | Term | +0.0 Hz | 0.0 A | | | | | | | | | | | | | | | | | | | | | | | | | | | | | | | | | | | | | | | | | | | | | | | | | | | | | | | | |
| SET1 | | | | | | | | | | | | | | | | | | | | | | | | | | | | | | | | | | | | | | | | | | | | | | | | | | | | | | | | | | | |
| Acceleration : | | 9.51 s | ENT | | | | | | | | | | | | | | | | | | | | | | | | | | | | | | | | | | | | | | | | | | | | | | | | | | | | | | | | |
| Deceleration : | | 9.67 s | | | | | | | | | | | | | | | | | | | | | | | | | | | | | | | | | | | | | | | | | | | | | | | | | | | | | | | | | |
| Acceleration 2 : | | 12.58 s | | | | | | | | | | | | | | | | | | | | | | | | | | | | | | | | | | | | | | | | | | | | | | | | | | | | | | | | | |
| Deceleration 2 : | | 13.45 s | | | | | | | | | | | | | | | | | | | | | | | | | | | | | | | | | | | | | | | | | | | | | | | | | | | | | | | | | |
| Begin Acc round: | | 2.3 s | | | | | | | | | | | | | | | | | | | | | | | | | | | | | | | | | | | | | | | | | | | | | | | | | | | | | | | | | |
| Code | | Quick | | | | | | | | | | | | | | | | | | | | | | | | | | | | | | | | | | | | | | | | | | | | | | | | | | | | | | | | | |
| RDY | Term | +0.0 Hz | 0.0 A | | | | | | | | | | | | | | | | | | | | | | | | | | | | | | | | | | | | | | | | | | | | | | | | | | | | | | | | |
| Acceleration | | | | | | | | | | | | | | | | | | | | | | | | | | | | | | | | | | | | | | | | | | | | | | | | | | | | | | | | | | | |
| 9.51 s | | | | | | | | | | | | | | | | | | | | | | | | | | | | | | | | | | | | | | | | | | | | | | | | | | | | | | | | | | | |
| Min = 0.1 | | Max = 999.9 | | | | | | | | | | | | | | | | | | | | | | | | | | | | | | | | | | | | | | | | | | | | | | | | | | | | | | | | | |
| << | | >> | | | | | | | | | | | | | | | | | | | | | | | | | | | | | | | | | | | | | | | | | | | | | | | | | | | | | | | | | |
| Quick | | | | | | | | | | | | | | | | | | | | | | | | | | | | | | | | | | | | | | | | | | | | | | | | | | | | | | | | | | | |
| Π L P - | [PARAM. SET SWITCHING] (continued) | | | | | | | | | | | | | | | | | | | | | | | | | | | | | | | | | | | | | | | | | | | | | | | | | | | | | | | | | | |
| P S 2 - | <p>[SET 2]</p> <p>This parameter can be accessed if at least 1 parameter has been selected in [PARAMETER SELECTION].</p> <p>Identical to [SET 1] (P S 1 -) page 215.</p> | | | | | | | | | | | | | | | | | | | | | | | | | | | | | | | | | | | | | | | | | | | | | | | | | | | | | | | | | | |

Parameters described in this page can be accessed by:

DRI- > CONF > FULL > FUN- > MLP- > PS3-

| Code | Name / Description | Adjustment range | Factory setting |
|---|---|------------------|-----------------|
| <i>MLP-</i> | [PARAM. SET SWITCHING] (continued) | | |
| <i>PS3-</i> | [SET 3] | | |
| ★ () <i>5301</i> ... <i>5315</i> | <p>This parameter can be accessed if [3 parameter sets] (<i>CHP2</i>) is not [No] (<i>ND</i>) and if at least 1 parameter has been selected in [PARAMETER SELECTION].</p> <p>Identical to [SET 1] (<i>PS1-</i>) page 215.</p> | | |

★ These parameters only appear if the corresponding function has been selected in another menu. When the parameters can also be accessed and adjusted from within the configuration menu for the corresponding function, their description is detailed in these menus, on the pages indicated, to aid programming.

() Parameter that can be modified during operation or when stopped.

Note: We recommend that a parameter set switching test is carried out while stopped and a check is made to verify that it has been performed correctly.

Some parameters are interdependent and in this case may be restricted at the time of switching.

Interdependencies between parameters must be respected, **even between different sets**.

Example: The highest **[Low speed]** (*L5P*) must be below the lowest **[High speed]** (*H5P*).

MULTIMOTORS / MULTICONFIGURATIONS

Motor or configuration switching [MULTIMOTORS/CONFIG.] (P P L -)

The drive may contain up to 3 configurations, which can be saved using the

[FACTORY SETTINGS] (F L 5 -) menu, page 69.

Each of these configurations can be activated remotely, enabling adaptation to:

- 2 or 3 different motors or mechanisms (multimotor mode)
- 2 or 3 different configurations for a single motor (multiconfiguration mode)

The two switching modes cannot be combined.

Note: The following conditions MUST be observed:

- Switching may only take place when stopped (drive locked). If a switching request is sent during operation, it will not be executed until the next stop.
- In the event of motor switching, the following additional conditions apply:
 - When the motors are switched, the power and control terminals concerned must also be switched as appropriate.
 - The maximum power of the drive must not be exceeded by any of the motors.
- All the configurations to be switched must be set and saved in advance in the same hardware configuration, this being the definitive configuration (option and communication cards). Failure to follow this instruction can cause the drive to lock on an [Incorrect config.] (L F F) state.

Menus and parameters switched in multimotor mode

- [SETTINGS] (S E L -)
- [MOTOR CONTROL] (d r L -)
- [INPUTS / OUTPUTS CFG] (I - D -)
- [COMMAND] (C L L -)
- [APPLICATION FUNCT.] (F u n -) with the exception of the [MULTIMOTORS/CONFIG.] function (to be configured once only)
- [FAULT MANAGEMENT] (F L L)
- [MY MENU]
- [USER CONFIG.]: The name of the configuration specified by the user in the [FACTORY SETTINGS] (F L 5 -) menu

Menus and parameters switched in multiconfiguration mode

As in multimotor mode, except for the motor parameters that are common to the 3 configurations:

- Rated current
- Thermal current
- Rated voltage
- Rated frequency
- Rated speed
- Rated power
- IR compensation
- Slip compensation
- Synchronous motor parameters
- Type of thermal protection
- Thermal state
- The auto-tuning parameters and motor parameters that can be accessed in expert mode
- Type of motor control

Note: No other menus or parameters can be switched.

Transfer of a drive configuration to another one, with graphic display terminal, when the drive uses [MULTIMOTORS/CONFIG.] (PFC-) function

- Let A be the source drive and B the drive addressed. In this example, switching is controlled by logic input.
1. Connect graphic display terminal to the drive A.
 2. Put logic input LI ([2 Configurations] (CnF1)) and LI ([3 Configurations] (CnF2)) to 0.
 3. Download configuration 0 in a file of graphic display terminal (example: file 1 of the graphic display terminal).
 4. Put logic input LI ([2 Configurations] (CnF1)) to 1 and leave logic input LI ([3 Configurations] (CnF2)) to 0.
 5. Download configuration 1 in a file of graphic display terminal (example: file 2 of the graphic display terminal).
 6. Put logic input LI ([3 Configurations] (CnF2)) to 1 and leave logic input LI ([2 Configurations] (CnF1)) to 1.
 7. Download configuration 2 in a file of graphic display terminal (example: file 3 of the graphic display terminal).
 8. Connect graphic display terminal to the drive B.
 9. Put logic input LI ([2 Configurations] (CnF1)) and LI ([3 Configurations] (CnF2)) to 0.
 10. Make a factory setting of the drive B.
 11. Download the configuration file 0 in the drive (file 1 of graphic display terminal in this example).
 12. Put logic input LI ([2 Configurations] (CnF1)) to 1 and leave logic input LI ([3 Configurations] (CnF2)) to 0.
 13. Download the configuration file 1 in the drive (file 2 of graphic display terminal in this example).
 14. Put logic input LI ([3 Configurations] (CnF2)) to 1 and leave logic input LI ([2 Configurations] (CnF1)) to 1.
 15. Download the configuration file 2 in the drive (file 3 of graphic display terminal in this example).

Note: Steps 6, 7, 14 et 15 are necessary only if [MULTIMOTORS/CONFIG.] (PFC-) function is used with 3 configurations or 3 motors.

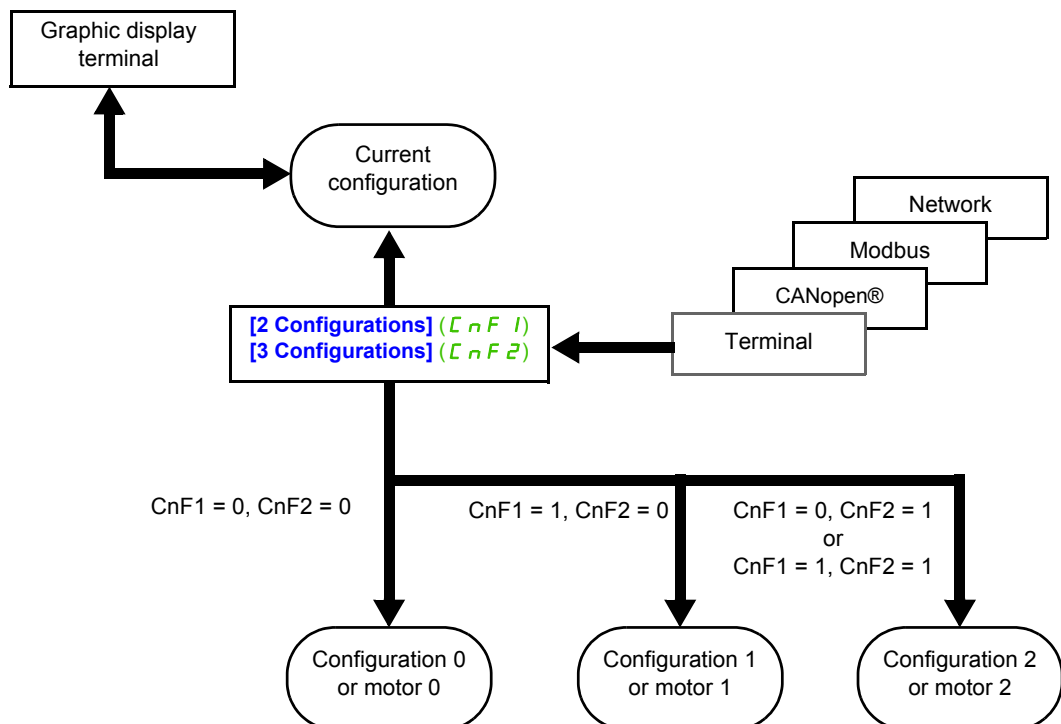

Switching command

Depending on the number of motors or selected configurations (2 or 3), the switching command is sent using one or two logic inputs. The table below lists the possible combinations.

| LI | LI | Number of configurations or active motors |
|----------------------------|----------------------------|---|
| 2 motors or configurations | 3 motors or configurations | |
| 0 | 0 | 0 |
| 1 | 0 | 1 |
| 0 | 1 | 2 |
| 1 | 1 | 2 |

Schematic diagram for multimotor mode

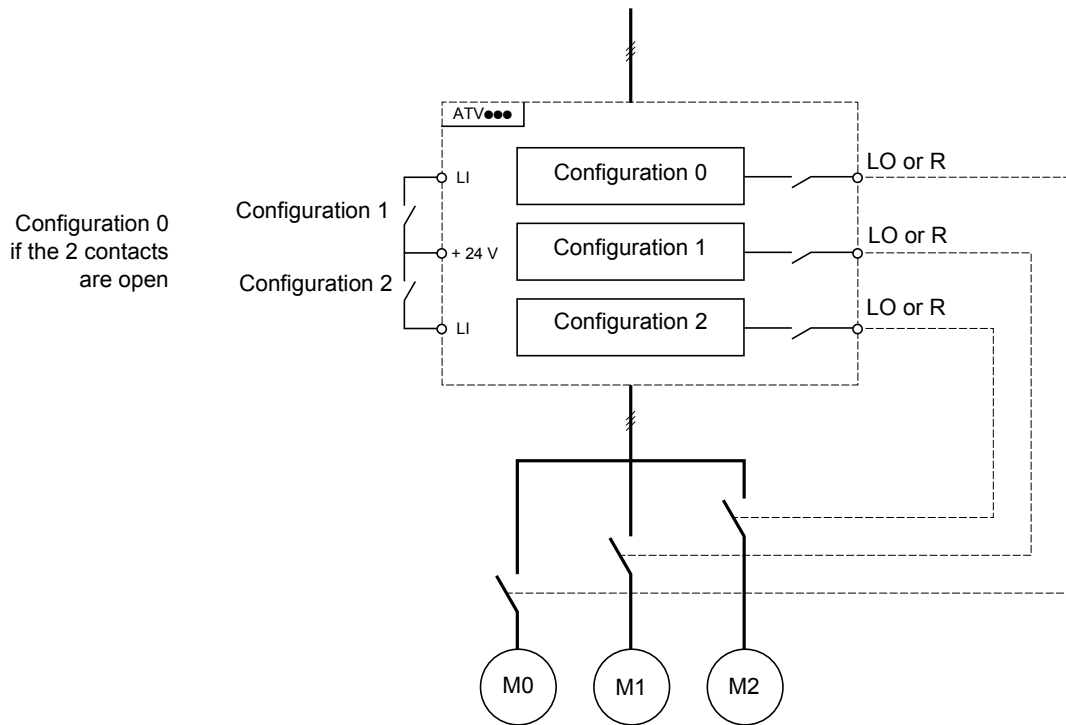

Auto-tuning in multimotor mode

This auto-tuning can be performed:

- Manually using a logic input when the motor changes.
- Automatically each time the motor is activated for the 1st time after switching on the drive, if the **[Automatic autotune] (A U E)** parameter on page 96 is set to **[Yes] (Y E 5)**.

Motor thermal states in multimotor mode:

The drive helps to protect the three motors individually. Each thermal state takes into account all stop times, if the drive power is not switched off.

Parameters described in this page can be accessed by:

DRI- > CONF > FULL > FUN- > MMC-

Configuration information output

| |
|--|
| CAUTION |
| <p>RISK OF DAMAGE TO THE MOTOR</p> <p>The motor thermal state of each motor is not memorized when power is switched off.</p> <p>To continue to protect the motors, it is required to:</p> <ul style="list-style-type: none"> • Perform auto-tuning on each motor every time the power is switched on, or • Use an external overload protection on each motor. <p>Failure to follow these instructions can result in equipment damage.</p> |

In the **[INPUTS / OUTPUTS CFG] (I - D -)** menu, a logic output can be assigned to each configuration or motor (2 or 3) for remote information transmission.

Note: As the **[INPUTS / OUTPUTS CFG] (I - D -)** menu is switched, these outputs must be assigned in all configurations in which information is required.

| Code | Name / Description | Adjustment range | Factory setting | | |
|---|--|------------------|------------------|----------------|---|
| FUN - | [APPLICATION FUNCT.] (continued) | | | | |
| MMC - | [MULTIMOTORS/CONFIG.] | | | | |
| CHN | [Multimotors] | | [No] (nD) | | |
| | <table border="1" style="width: 100%; border-collapse: collapse;"> <tr> <td style="text-align: center;">CAUTION</td> </tr> <tr> <td> <p>RISK OF DAMAGE TO THE MOTOR</p> <p>When [Multimotors] (CHN) is set to [Yes] (YES), the motor thermal state of each motor is not memorized when power is switched off.</p> <p>To continue to protect the motors, it is required to :</p> <ul style="list-style-type: none"> • Perform auto-tuning on each motor every time the power is switched on, or • Use an external overload protection on each motor. <p>Failure to follow these instructions can result in equipment damage.</p> </td> </tr> </table> | | | CAUTION | <p>RISK OF DAMAGE TO THE MOTOR</p> <p>When [Multimotors] (CHN) is set to [Yes] (YES), the motor thermal state of each motor is not memorized when power is switched off.</p> <p>To continue to protect the motors, it is required to :</p> <ul style="list-style-type: none"> • Perform auto-tuning on each motor every time the power is switched on, or • Use an external overload protection on each motor. <p>Failure to follow these instructions can result in equipment damage.</p> |
| CAUTION | | | | | |
| <p>RISK OF DAMAGE TO THE MOTOR</p> <p>When [Multimotors] (CHN) is set to [Yes] (YES), the motor thermal state of each motor is not memorized when power is switched off.</p> <p>To continue to protect the motors, it is required to :</p> <ul style="list-style-type: none"> • Perform auto-tuning on each motor every time the power is switched on, or • Use an external overload protection on each motor. <p>Failure to follow these instructions can result in equipment damage.</p> | | | | | |
| nD YES | <p>[No] (nD): Multiconfiguration possible</p> <p>[Yes] (YES): Multimotor possible</p> | | | | |
| CNFI | [2 Configurations] | | [No] (nD) | | |
| | Switching of 2 motors or 2 configurations. | | | | |
| nD LI1 ... | <p>[No] (nD): No switching</p> <p>[LI1] (LI1): Logical input LI1</p> <p>[...] (...): See the assignment conditions on page 138</p> | | | | |
| CNF2 | [3 Configurations] | | [No] (nD) | | |
| | Switching of 3 motors or 3 configurations. | | | | |
| | Identical to [2 Configurations] (CNFI) page 220 . | | | | |
| | Note: In order to obtain 3 motors or 3 configurations, [2 Configurations] (CNFI) must also be configured. | | | | |

Parameters described in this page can be accessed by:

DRI- > CONF > FULL > FUN- > TNL-

AUTO TUNING BY LOGIC INPUT

| Code | Name / Description | Adjustment range | Factory setting |
|----------------|---|------------------|-------------------|
| F U n - | [APPLICATION FUNCT.] (continued) | | |
| t n L - | [AUTO TUNING BY LI] | | |
| t U L | [Auto-tune assign.] | | [No] (n 0) |
| | Auto-tuning is performed when the assigned input or bit changes to 1. Note: Auto-tuning causes the motor to start up. | | |
| n 0 | [No] (n 0): Not assigned | | |
| L I I | [LI1] (L I I): Logical input LI1 | | |
| . . . | [...] (. . .): See the assignment conditions on page 138 | | |

TRAVERSE CONTROL

Function for winding reels of yarn (in textile applications):

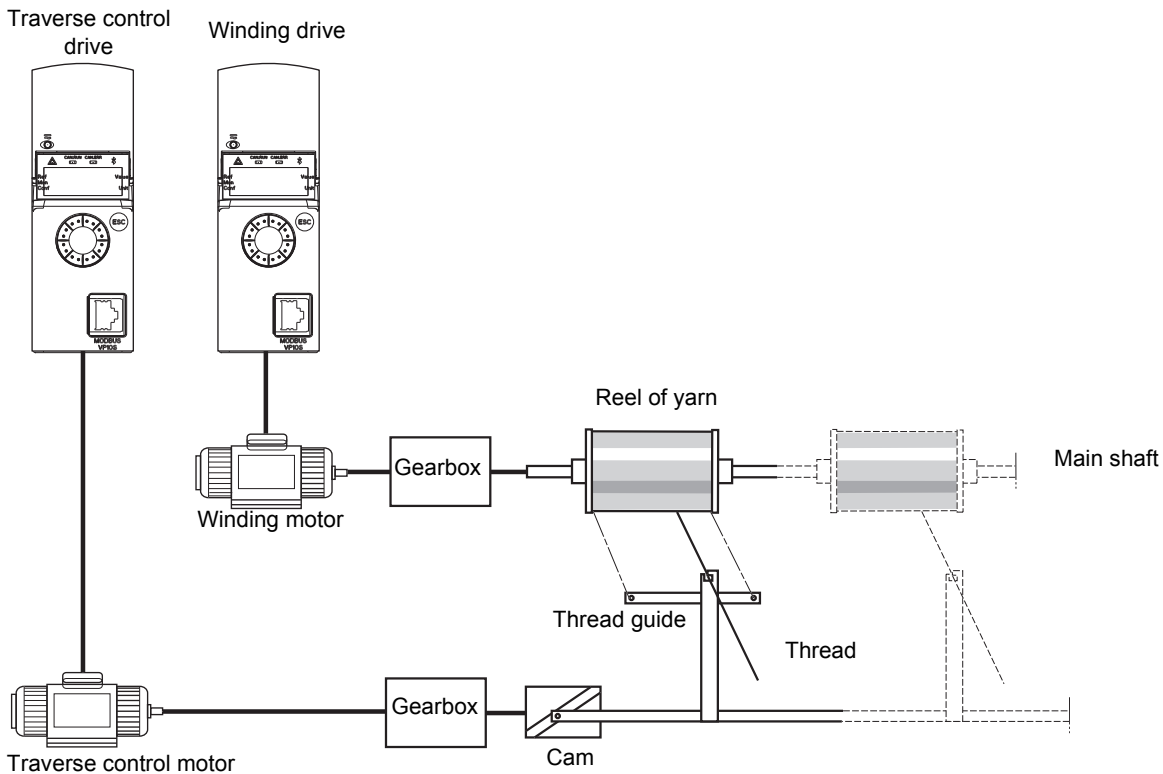

The speed of rotation of the cam must follow a precise profile to ensure that the reel is steady, compact and linear:

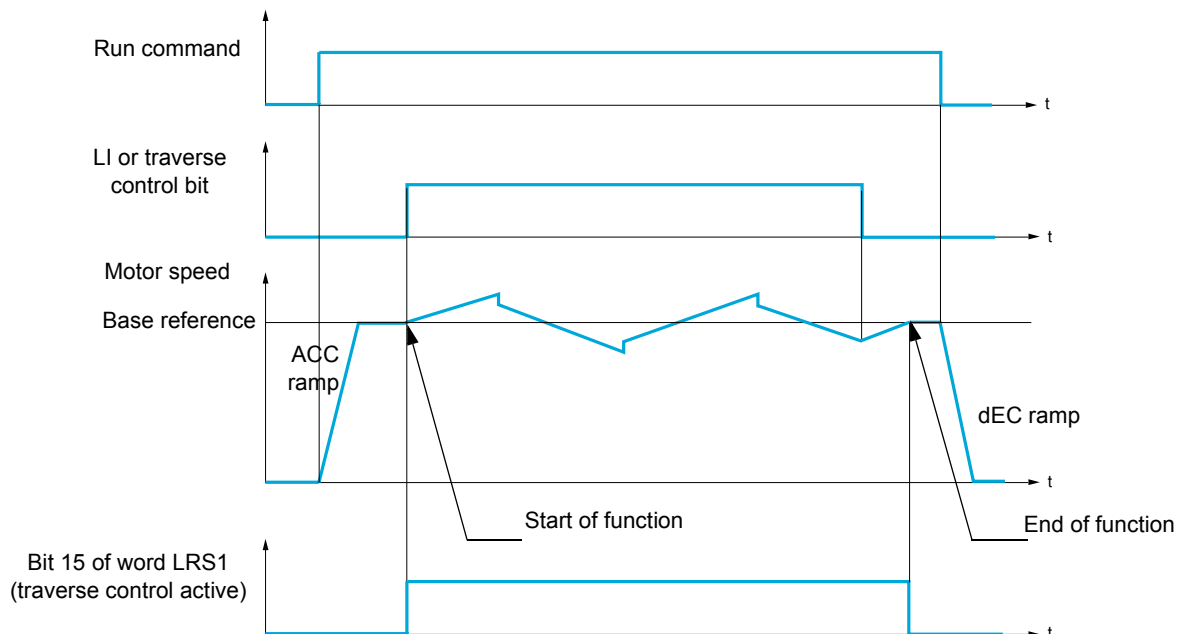

The function starts when the drive has reached its base reference and the traverse control command has been enabled.

When the traverse control command is disabled, the drive returns to its base reference, following the ramp determined by the traverse control function. The function then stops, as soon as it has returned to this reference.

Bit 15 of word LRS1 is at 1 while the function is active.

Function parameters

These define the cycle of frequency variations around the base reference, as shown in the diagram below:

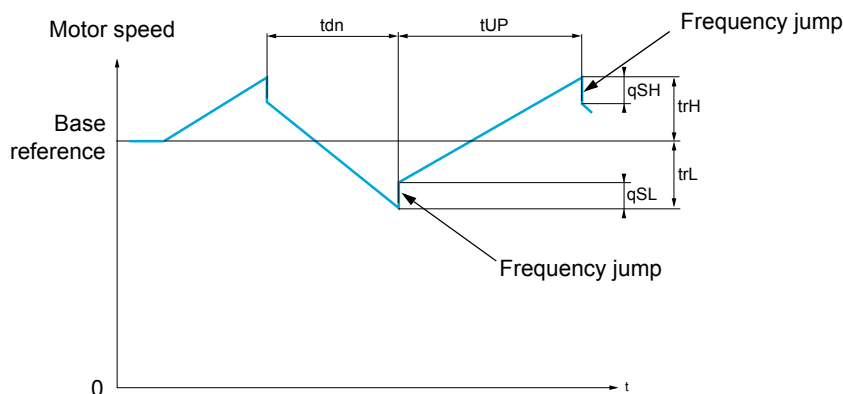

| | |
|------------|--|
| ErC | [Yarn control] (ErC) : Assignment of the traverse control command to a logic input or to a communication bus control word bit |
| ErH | [Traverse freq. high] (ErH) : in Hertz |
| ErL | [Traverse Freq. Low] (ErL) : in Hertz |
| qSH | [Quick step High] (qSH) : in Hertz |
| qSL | [Quick step Low] (qSL) : in Hertz |
| tUP | [Traverse ctrl. accel.] (tUP) : time, in seconds |
| tdn | [Traverse ctrl. decel] (tdn) : time, in seconds |

Reel parameters:

| | |
|------------|--|
| tbD | <p>[Reel time] (tbD): Time taken to make a reel, in minutes. This parameter is intended to signal the end of winding. When the traverse control operating time since command [Yarn control] (ErC) reaches the value of [Reel time] (tbD), the logic output or one of the relays changes to state 1, if the corresponding function [End reel] (EbD) has been assigned. The traverse control operating time tbDt can be monitored online by a communication bus.</p> |
| dtF | <p>[Decrease ref. speed] (dtF): Decrease in the base reference. In certain cases, the base reference has to be reduced as the reel increases in size. The [Decrease ref. speed] (dtF) value corresponds to time [Reel time] (tbD). Once this time has elapsed, the reference continues to fall, following the same ramp. If low speed [Low speed] (LSP) is at 0, the speed reaches 0 Hz, the drive stops and must be reset by a new run command. If low speed [Low speed] (LSP) is not 0, the traverse control function continues to operate above [Low speed] (LSP).</p> <div style="display: flex; flex-direction: column; align-items: center;"> </div> |

rtr

[Init. traverse ctrl] Reinitialize traverse control.

This command can be assigned to a logic input or to a communication bus control word bit. It resets the **EbO** alarm and the **EbOt** operating time to 0 and reinitializes the reference to the base reference. As long as **rtr** remains at 1, the traverse control function is disabled and the speed remains the same as the base reference. This command is used primarily when changing reels.

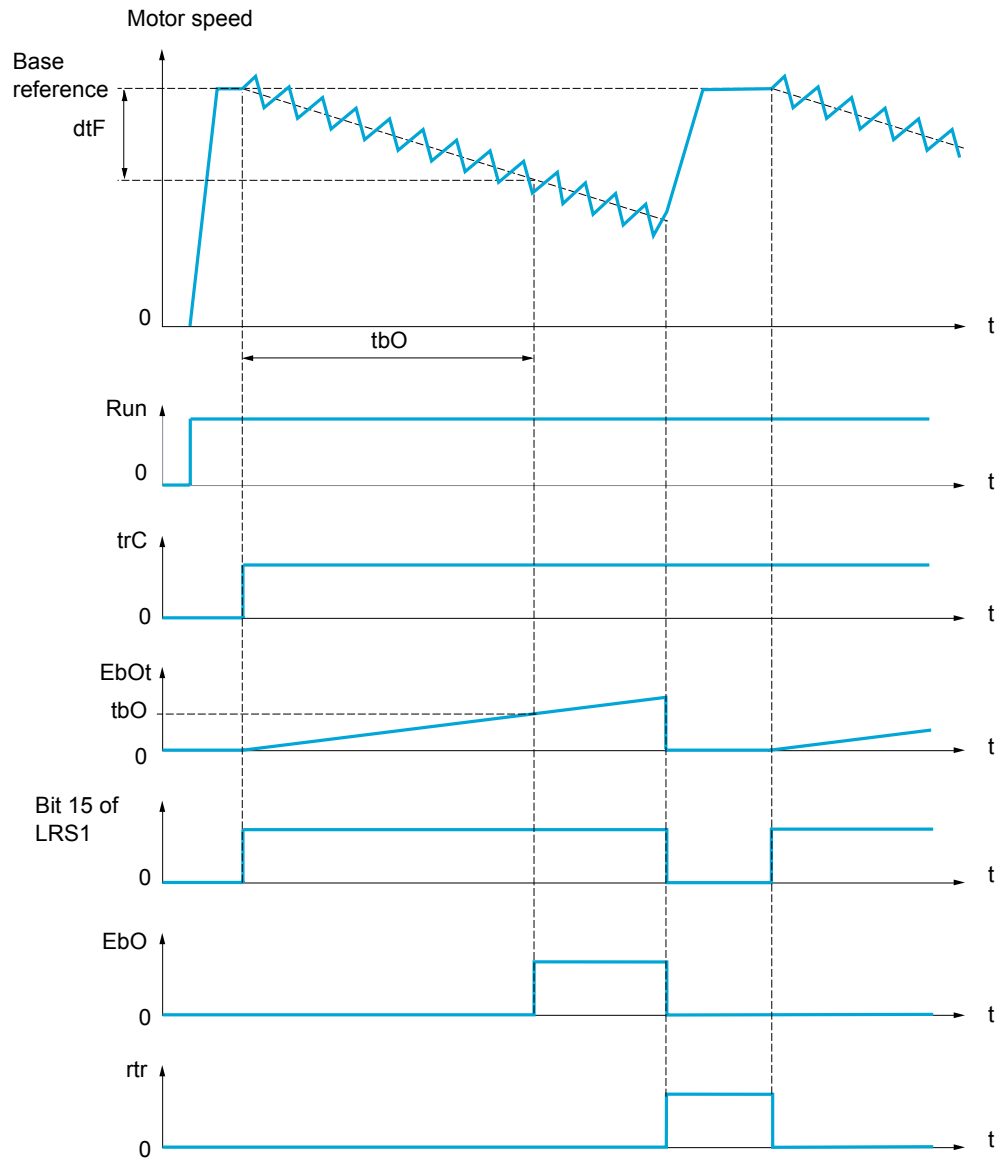

Counter wobble

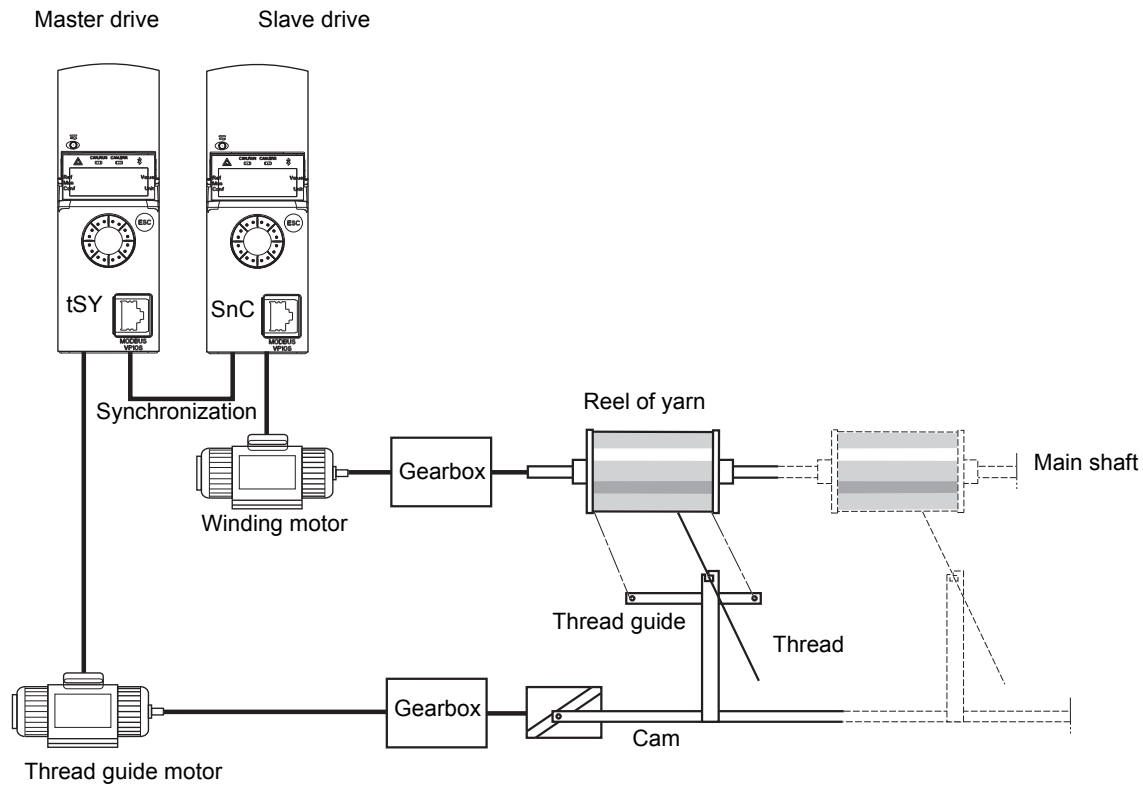

The Counter wobble function is used in certain applications to obtain a constant yarn tension when the Traverse control function is producing considerable variations in speed on the yarn guide motor ([\[Traverse freq. high\] \(E r H\)](#) and [\[Traverse Freq. low\] \(E r L\)](#), see [\[Traverse freq. high\] \(E r H\)](#) page [227](#)).

Two motors must be used (one master and one slave).

The master controls the speed of the yarn guide, the slave controls the winding speed. The function assigns the slave a speed profile, which is in antiphase to that of the master. This means that synchronization is required, using one of the master's logic outputs and one of the slave's logic inputs.

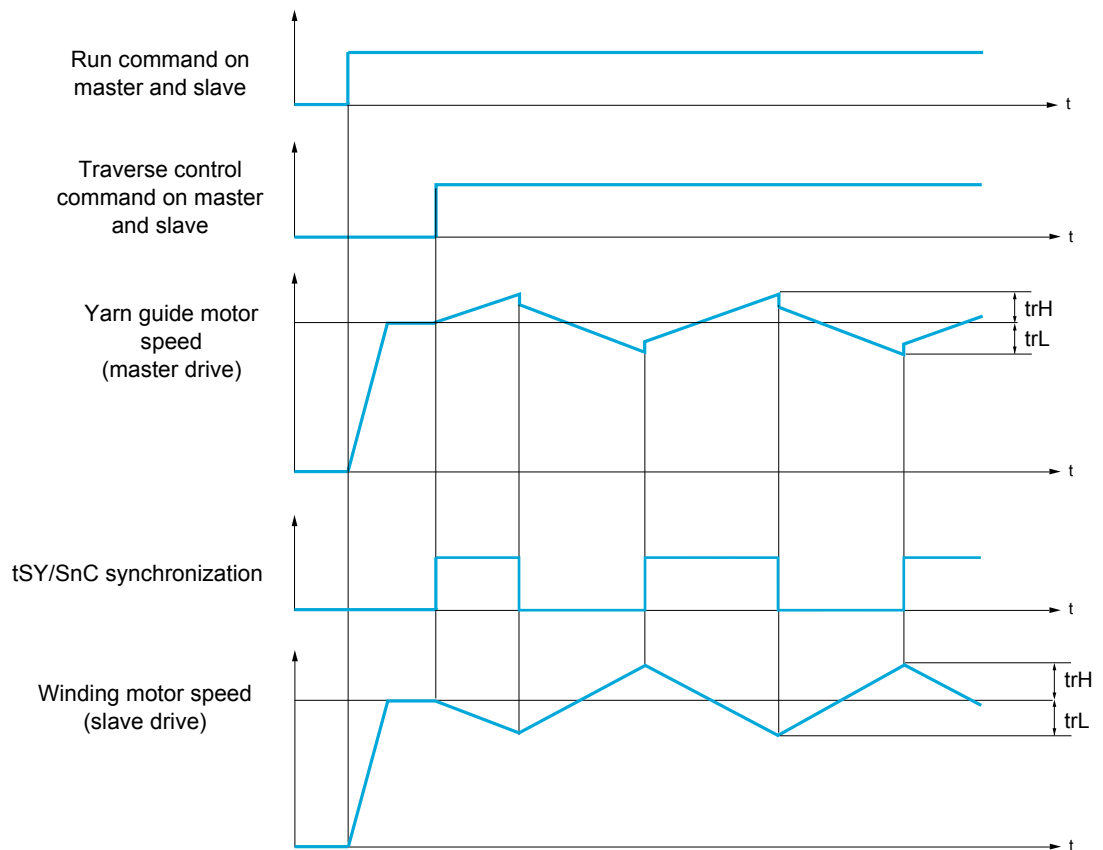

Connection of synchronization I/O

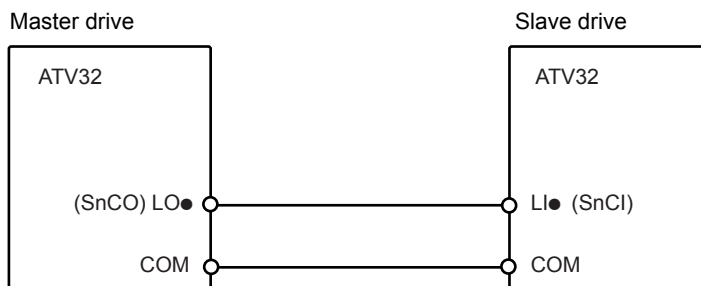

The starting conditions for the function are:

- Base speeds reached on both drives
- **[Yarn control] (E r L)** input activated
- Synchronization signal present

Note: The **[Quick step High] (9 5 H)** and **[Quick step Low] (9 5 L)** parameters should generally be kept at 0.

| Code | Name / Description | Adjustment range | Factory setting |
|--------------------------|---|---|------------------|
| F U n - | [APPLICATION FUNCT.] (continued) | | |
| t r D - | [TRAVERSE CONTROL] Note: This function cannot be used with certain other functions. Follow the instructions on page 148 . | | |
| t r C | [Yarn control] The Traverse control cycle starts when the assigned input or bit changes to 1 and stops when it changes to 0. [No] (nD) nD [No] (nD): Function inactive, thereby helping to prevent access to other parameters L I 1 [L1] (L I 1): Logical input LI1 ... [...]: See the assignment conditions on page 138 | | [No] (nD) |
| t r H ★ (1) | [Traverse freq. high] Traverse frequency high. | 0 to 10 Hz | 4 Hz |
| t r L ★ (1) | [Traverse Freq. Low] Traverse frequency low. | 0 to 10 Hz | 4 Hz |
| q s H ★ (1) | [Quick step High] Quick step high. | 0 to [Traverse freq. high] (t r H) | 0 Hz |
| q s L ★ (1) | [Quick step Low] Quick step low. | 0 to [Traverse Freq. Low] (t r L) | 0 Hz |
| t U P ★ (1) | [Traverse ctrl. accel.] Acceleration traverse control. | 0.1 to 999.9 s | 4 s |
| t d n ★ (1) | [Traverse ctrl. decel] Deceleration traverse control. | 0.1 to 999.9 s | 4 s |
| t b D ★ (1) | [Reel time] Reel execution time. | 0 to 9,999 min | 0 min |
| E b D ★ | [End reel] The assigned output or relay changes to state 1 when the traverse control operating time reaches the [Reel time] (t b D) . nD [No] (nD): Not assigned L O 1 [LO1] (L O 1): Logical output LO1 r 2 [R2] (r 2): Relay R2 d O 1 [dO1] (d O 1): Analog output AO1 functioning as a logic output. Selection can be made if [AO1 assignment] (R O 1) page 129 is set to [No] (nD) . | | [No] (nD) |

Parameters described in this page can be accessed by:

DRI- > CONF > FULL > FUN- > TRO-

| Code | Name / Description | Adjustment range | Factory setting |
|--|--|------------------|-----------------|
| <p>5 n C</p> <p>★</p> <p>n D</p> <p>L I I</p> <p>...</p> | <p>[Counter wobble]</p> <p>Synchronization input. To be configured on the winding drive (slave) only.</p> <p>[No] (n D): Function inactive, thereby helping to prevent access to other parameters [LI1] (L I I): Logical input LI1 [...]: See the assignment conditions on page 138</p> | | [No] (n D) |
| <p>ε 5 Y</p> <p>★</p> <p>n D</p> <p>L O I</p> <p>r 2</p> <p>d O I</p> | <p>[Sync. wobble]</p> <p>Synchronization output. To be configured on the yarn guide drive (master) only.</p> <p>[No] (n D): Function not assigned [LO1] (L O I) [R2] (r 2) [dO1] (d O I): Analog output AO1 functioning as a logic output. Selection can be made if [AO1 assignment] (R O I) page 129 is set to [No] (n D).</p> | | [No] (n D) |
| <p>d ε F</p> <p>★</p> <p>()</p> | <p>[Decrease ref. speed]</p> <p>Decrease in the base reference during the traverse control cycle.</p> | 0 to 599 Hz | 0 Hz |
| <p>r ε r</p> <p>★</p> <p>n D</p> <p>L I I</p> <p>...</p> | <p>[Init. traverse ctrl]</p> <p>When the state of the assigned input or bit changes to 1, the traverse control operating time is reset to 0, along with [Decrease ref. speed] (d ε F).</p> <p>[No] (n D): Function not assigned [LI1] (L I I): Logical input LI1 [...]: See the assignment conditions on page 138</p> | | [No] (n D) |

(1) The parameter can also be accessed in the [SETTINGS] (5 E ε -) menu.



These parameters only appear if the corresponding function has been selected in another menu. When the parameters can also be accessed and adjusted from within the configuration menu for the corresponding function, their description is detailed in these menus, on the pages indicated, to aid programming.

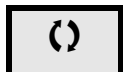

Parameter that can be modified during operation or when stopped.

HIGH SPEED SWITCHING

| Code | Name / Description | Adjustment range | Factory setting |
|--|---|------------------|---------------------|
| <i>F U n -</i> | [APPLICATION FUNCT.] (continued) | | |
| <i>C H S -</i> | [HSP SWITCHING] | | |
| <i>S H 2</i> | [2 High speed] High Speed Switching. | | [No] (<i>n 0</i>) |
| <i>n 0</i> <i>F t A</i> <i>F 2 A</i> <i>L I 1</i> <i>. . .</i> | [No] (<i>n 0</i>): Function not assigned [Freq. Th. attain.] (<i>F t A</i>): Frequency threshold attained [Freq. Th 2 attain.] (<i>F 2 A</i>): Frequency threshold 2 attained [LI1] (<i>L I 1</i>): Logical input LI1 [. . .] (<i>. . .</i>): See the assignment conditions on page 138 | | |
| <i>S H 4</i> | [4 High speed] High Speed Switching. Note: In order to obtain 4 High speed, [2 High speed] (<i>S H 2</i>) must also be configured. Identical to [2 High speed] (<i>S H 2</i>) page 229 . | | [No] (<i>n 0</i>) |
| <i>H S P</i> () | [High speed] Motor frequency at maximum reference, can be set between [Low speed] (<i>L S P</i>) and [Max frequency] (<i>t F r</i>). The factory setting changes to 60 Hz if [Standard mot. freq] (<i>b F r</i>) is set to [60Hz NEMA] (<i>5 0</i>). | 0 to 599 Hz | 50 Hz |
| <i>H S P 2</i> ★ () | [High speed 2] Visible if [2 High speed] (<i>S H 2</i>) is not set to [No] (<i>n 0</i>). Identical to [High speed] (<i>H S P</i>) page 229 . | 0 to 599 Hz | 50 Hz |
| <i>H S P 3</i> ★ () | [High speed 3] Visible if [4 High speed] (<i>S H 4</i>) is not set to [No] (<i>n 0</i>). Identical to [High speed] (<i>H S P</i>) page 229 . | 0 to 599 Hz | 50 Hz |
| <i>H S P 4</i> ★ () | [High speed 4] Visible if [4 High speed] (<i>S H 4</i>) is not set to [No] (<i>n 0</i>). Identical to [High speed] (<i>H S P</i>) page 229 . | 0 to 599 Hz | 50 Hz |

 These parameters only appear if the corresponding function has been selected in another menu. When the parameters can also be accessed and adjusted from within the configuration menu for the corresponding function, their description is detailed in these menus, on the pages indicated, to aid programming.

 Parameter that can be modified during operation or when stopped.

Fault Management

With integrated display terminal:

Summary of functions:

| Code | Name | Page |
|--------------|---------------------------|---------------------|
| <i>P t C</i> | [PTC MANAGEMENT] | 232 |
| <i>r S t</i> | [FAULT RESET] | 232 |
| <i>R t r</i> | [AUTOMATIC RESTART] | 234 |
| <i>A I S</i> | [ALARMS SETTING] | 234 |
| <i>F L r</i> | [CATCH ON THE FLY] | 235 |
| <i>t H t</i> | [MOTOR THERMAL PROT.] | 237 |
| <i>O P L</i> | [OUTPUT PHASE LOSS] | 238 |
| <i>I P L</i> | [INPUT PHASE LOSS] | 238 |
| <i>O H L</i> | [DRIVE OVERHEAT] | 239 |
| <i>S A t</i> | [THERMAL ALARM STOP] | 240 |
| <i>E t F</i> | [EXTERNAL FAULT] | 240 |
| <i>U S b</i> | [UNDERVOLTAGE MGT] | 241 |
| <i>t I t</i> | [IGBT TESTS] | 242 |
| <i>L F L</i> | [4-20mA LOSS] | 242 |
| <i>I n H</i> | [FAULT INHIBITION] | 243 |
| <i>C L L</i> | [COM. FAULT MANAGEMENT] | 243 |
| <i>t I d</i> | [TORQUE OR I LIM. DETECT] | 245 |
| <i>F q F</i> | [FREQUENCY METER] | 247 |
| <i>d L d</i> | [DYNAMIC LOAD DETECT.] | 248 |
| <i>t n F</i> | [AUTO TUNING FAULT] | 249 |
| <i>P P I</i> | [CARDS PAIRING] | 250 |
| <i>U L d</i> | [PROCESS UNDERLOAD] | 251 |
| <i>O L d</i> | [PROCESS OVERLOAD] | 253 |
| <i>L F F</i> | [FALLBACK SPEED] | 253 |
| <i>F S t</i> | [RAMP DIVIDER] | 254 |
| <i>d C I</i> | [DC INJECTION] | 254 |

From **ConF** menu

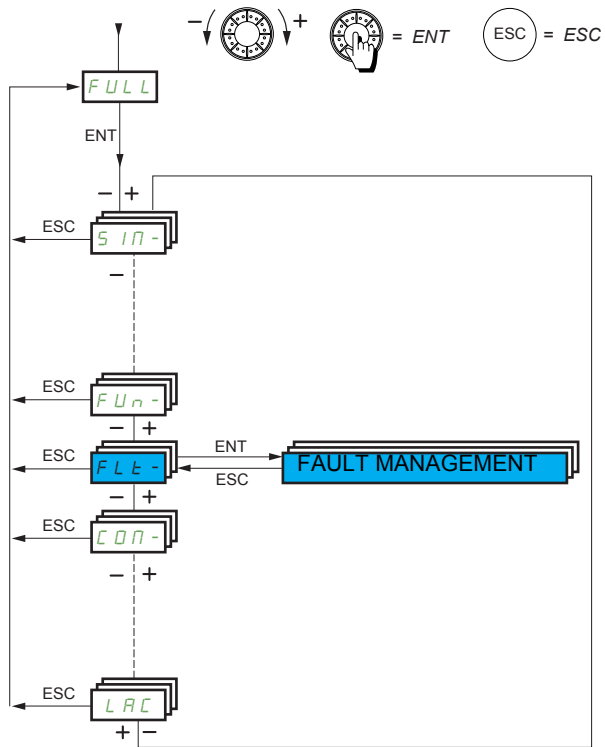

The parameters in the **[FAULT MANAGEMENT]** (**FLt -**) menu can only be modified when the drive is stopped and there is no run command, except for parameters with a **(C)** symbol in the code column, which can be modified with the drive running or stopped.

Parameters described in this page can be accessed by:

DRI -> CONF > FULL > FLT-

PTC probe

1 set of PTC probe can be managed by the drive in order to help to protect the motor: on logic input LI6 converted for this use by switch SW2 on the control block.

The PTC probe is monitored for the following detected faults:

- Motor overheating
- Sensor break
- Sensor short-circuit

Protection via PTC probe does not disable protection via I²t calculation performed by the drive (the two types of protection can be combined).

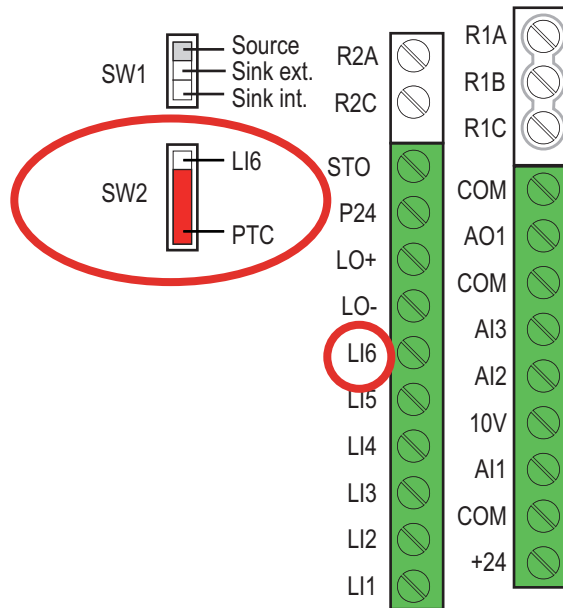







| Code | Name / Description | Adjustment range | Factory setting |
|-------------|---|------------------|-----------------|
| FULL | [FULL] (continued) | | |
| FLt- | [FAULT MANAGEMENT] | | |
| PECL | [PTC MANAGEMENT] | | |
| PECL | [LI6 = PTC probe] Check first that the switch SW2 on the control block is set to PTC. | | [No] (n0) |
| n0 | [No] (n0): Not used | | |
| AS | [Always] (AS): PTC probe are monitored permanently, even if the power supply is not connected (as long as the control remains connected to the power supply) | | |
| rd5 | [Power ON] (rd5): PTC probe are monitored while the drive power supply is connected | | |
| r5 | [Motor ON] (r5): PTC probe are monitored while the motor power supply is connected | | |
| FLt- | [FAULT MANAGEMENT] (continued) | | |
| r5t- | [FAULT RESET] | | |
| r5F | [Fault reset] Detected faults are cleared manually when the assigned input or bit changes to 1, if the cause of the detected fault has disappeared. The STOP/RESET key on the graphic display terminal performs the same function. Following detected faults can be cleared manually : <i>ASf, brF, bLF, CnF, COF, dLF, EPF1, EPF2, FbE5, FCF2, InF9, InFA, InFb, LCF, LFF3, ObF, OHF, OLC, OLF, OPF1, OPF2, OSF, OeFL, PHF, PefL, SCF4, SCF5, SLF1, SLF2, SLF3, SOF, SPF, SSF, tJF, tnf</i> and <i>ULF</i> . | | [No] (n0) |
| n0 | [No] (n0): Function inactive | | |
| L11 | [LI1] (L11): Logical input LI1 | | |
| ... | [...] (...): See the assignment conditions on page 138 | | |

| Code | Name / Description | Adjustment range | Factory setting |
|------------------------------|---|------------------|--------------------------|
| <p><i>r P R</i></p> <p>★</p> | <p>[Product reset assig.]</p> <div style="border: 1px solid black; padding: 5px; text-align: center;"> <p>⚠ DANGER</p> <p>UNINTENDED EQUIPMENT OPERATION</p> <p>This configuration enables to reset the drive. Check this action will not endanger personnel or equipment in any way. Failure to follow these instructions will result in death or serious injury.</p> </div> <p>This parameter can only be modified if [3.1 ACCESS LEVEL] (L R C) is set to [Expert] (E P r) mode. Drive reinitialization via logic input. Can be used to reset all detected faults without having to disconnect the drive from the power supply. The drive is reinitialized on a rising edge (change from 0 to 1) of the assigned input. The drive can only be reinitialized when locked. To assign reinitialization, press and hold down the ENT key for 2 s.</p> <p><i>n 0</i> [No] (n 0): Function inactive <i>L 1 1</i> [L1] (L 1 1): Logical input L1 ... <i>L 1 6</i> [L16] (L 1 6): Logical input L16 <i>L A 1 1</i> [LA1] (L A 1 1): Logical input AI1 <i>L A 1 2</i> [LA2] (L A 1 2): Logical input AI2 <i>O L 0 1</i> [OL01] (O L 0 1): Function blocks: Logical Output 01 ... <i>O L 1 0</i> [OL10] (O L 1 0): Function blocks: Logical Output 10</p> | | <p>[No] (n 0)</p> |
| <p><i>r P</i></p> <p>★</p> | <p>[Product reset]</p> <div style="border: 1px solid black; padding: 5px; text-align: center;"> <p>⚠ DANGER</p> <p>UNINTENDED EQUIPMENT OPERATION</p> <p>You are going to reset the drive. Check this action will not endanger personnel or equipment in any way. Failure to follow these instructions will result in death or serious injury.</p> </div> <p>This parameter can only be accessed if [3.1 ACCESS LEVEL] (L R C) is set to [Expert] (E P r) mode. Drive reinitialization. Can be used to reset all detected faults without having to disconnect the drive from the power supply.</p> <p><i>n 0</i> [No] (n 0): Function inactive <i>Y E 5</i> [Yes] (Y E 5): Reinitialization. Press and hold down the ENT key for 2 s. The parameter changes back to [No] (n 0) automatically as soon as the operation is complete. The drive can only be reinitialized when locked.</p> | | <p>[No] (n 0)</p> |

Parameters described in this page can be accessed by:

DRI- > CONF > FULL > FLT-> ATR-

| Code | Name / Description | Adjustment range | Factory setting |
|--|---|------------------|------------------------|
| FLt- | [FAULT MANAGEMENT] (continued) | | |
| AR- | [AUTOMATIC RESTART] | | |
| AR | [Automatic restart] | | [No] (nD) |
|  2 s | <div style="border: 1px solid black; padding: 5px;"> <p style="text-align: center;">⚠ DANGER</p> <p>UNINTENDED EQUIPMENT OPERATION</p> <ul style="list-style-type: none"> The automatic restart can only be used on machines or installations which do not pose any danger to either personnel or equipment. If the automatic restart is activated, R1 will only indicate a fault has been detected once the time-out period for the restart sequence has expired. The equipment must be used in compliance with national and regional safety regulations. <p>Failure to follow these instructions will result in death or serious injury.</p> </div> <p>The drive fault relay remains activated if this function is active. The speed reference and the operating direction must be maintained.</p> <p>Use 2-wire control ([2/3 wire control] (tCC) is set to [2 wire] (2C) and [2 wire type] (tCE) is set to [Level] (LEL), see [2/3 wire control] (tCC) page 73).</p> <p>If the restart has not taken place once the configurable time AR has elapsed, the procedure is aborted and the drive remains locked until it is turned off and then on again.</p> <p>The fault codes, which permit this function, are listed on page 293.</p> <p>nD [No] (nD): Function inactive YES [Yes] (YES): Automatic restart, after locking in fault state, if the detected fault has disappeared and the other operating conditions permit the restart. The restart is performed by a series of automatic attempts separated by increasingly longer waiting periods: 1 s, 5 s, 10 s, then 1 minute for the following attempts.</p> | | |
| AR | [Max. restart time] | | [5 minutes] (5) |
| ★ | <p>This parameter appears if [Automatic restart] (AR) is set to [Yes] (YES). It can be used to limit the number of consecutive restarts on a recurrent detected fault.</p> <p>5 [5 min] (5): 5 minutes 10 [10 minutes] (10): 10 minutes 30 [30 minutes] (30): 30 minutes 1h [1 hour] (1h): 1 hour 2h [2 hours] (2h): 2 hours 3h [3 hours] (3h): 3 hours CE [Unlimited] (CE): Unlimited</p> | | |
| FLt- | [FAULT MANAGEMENT] (continued) | | |
| ALS- | [ALARM SETTING] | | |
| CTd  (1) | [Current threshold] Motor current threshold. | 0 to 1.5 In (1) | INV |
| Ftd  | [Freq. threshold] Motor frequency threshold. | 0 to 599 Hz | 50 Hz |
| F2d  | [Freq. threshold 2] Motor frequency threshold. | 0 to 599 Hz | 50 Hz |
| TEH  | [High torque thd.] High torque frequency threshold. | -300 to 300% | 100% |
| TEL  | [Low torque thd.] Low torque frequency threshold. | -300 to 300% | 50% |

Parameters described in this page can be accessed by:

| Code | Name / Description | Adjustment range | Factory setting |
|----------------------------------|---|------------------|-------------------|
| F 9 L ★ | [Pulse warning thd.] Frequency level. Visible if [Frequency meter] (F 9 F) is not [No] (n 0) . | 0 to 20,000 Hz | 0 Hz |
| F L E - | [FAULT MANAGEMENT] (continued) | | |
| F L r - | [CATCH ON THE FLY] Note: This function cannot be used with certain other functions. Follow the instructions on page 147 . | | |
| F L r n 0 y e s | [Catch on the fly] Used to enable a smooth restart if the run command is maintained after the following events: - Loss of line supply or disconnection. - Clearance of current detected fault or automatic restart. - Freewheel stop. The speed given by the drive resumes from the estimated speed of the motor at the time of the restart, then follows the ramp to the reference speed. This function requires 2-wire level control. When the function is operational, it activates at each run command, resulting in a slight delay of the current (0.5 s max). [Catch on the fly] (F L r) is forced to [No] (n 0) if brake logic control [Brake assignment] (b L C) is assigned (page 179) or if [Auto DC injection] (A d C) is set to [Continuous] (C E) page 161 . n 0 [No] (n 0) : Function inactive y e s [Yes] (y e s) : Function active | | [No] (n 0) |

(1) In corresponds to the rated drive current indicated in the Installation manual and on the drive nameplate.



These parameters only appear if the corresponding function has been selected in another menu. When the parameters can also be accessed and adjusted from within the configuration menu for the corresponding function, their description is detailed in these menus, on the pages indicated, to aid programming.

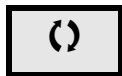

Parameter that can be modified during operation or when stopped.



To change the assignment of this parameter, press the ENT key for 2 s.

Motor thermal protection

Function

Thermal protection by calculating the I^2t .

Note: The motor thermal state is not saved when the drive is switched off.

- Self-cooled motors: The tripping curves depend on the motor frequency.
- Force-cooled motors: Only the 50 Hz tripping curve needs to be considered, regardless of the motor frequency.

The following curves represent the trip time in seconds:

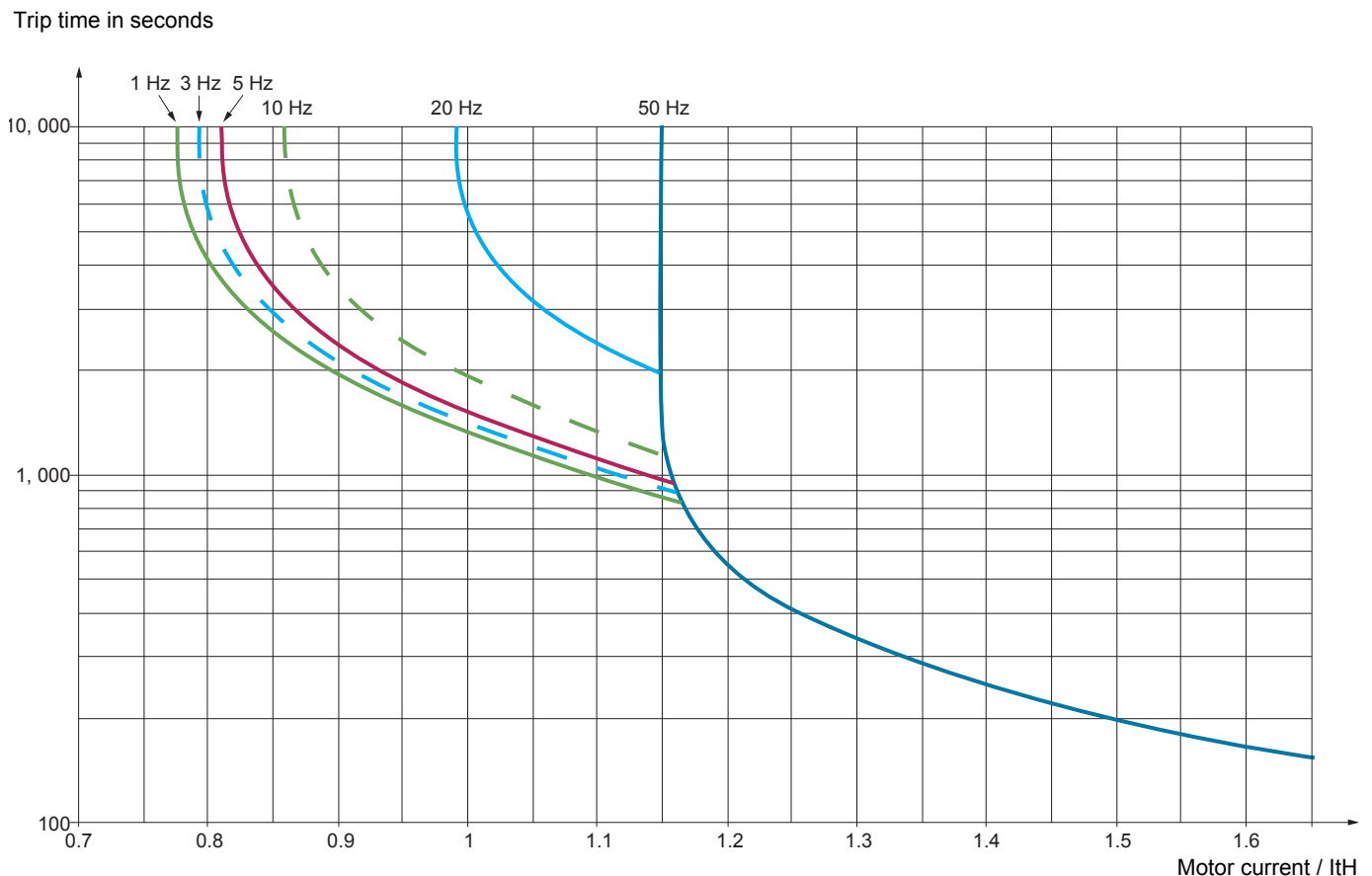

CAUTION

RISK OF DAMAGE TO THE MOTOR

External protection against overloads is required under the following circumstances:





- When the product is being switched on again, as there is no memory to record the motor thermal state
- When supplying more than one motor
- When supplying motors with ratings less than 0.2 times the nominal drive current
- When using motor switching

Failure to follow these instructions can result in equipment damage.

| Code | Name / Description | Adjustment range | Factory setting |
|--------------------|---|------------------|------------------------------|
| FLT - | [FAULT MANAGEMENT] (continued) | | |
| THE - | [MOTOR THERMAL PROT.] | | |
| THE | [Motor protect. type] Note: A trip will occur when the thermal state reaches 118% of the rated state and reactivation will occur when the state falls back below 100%. ND [No] (ND): No protection ACL [Self cooled] (ACL): For self-cooled motors FCL [Force-cool] (FCL): For force-cooled motors | | [Self cooled] (ACL) |
| TEd (1) | [Motor therm. level] Trip threshold for motor thermal alarm (logic output or relay). | 0 to 118% | 100% |
| TEd2 (1) | [Motor2 therm. level] Trip threshold for motor 2 thermal alarm (logic output or relay). | 0 to 118% | 100% |
| TEd3 (1) | [Motor3 therm. level] Trip threshold for motor 3 thermal alarm (logic output or relay). | 0 to 118% | 100% |
| OLL | [Overload fault mgt] <div style="border: 1px solid black; padding: 10px; text-align: center;"> <p>CAUTION</p> <p>RISK OF DAMAGE TO THE MOTOR</p> <p>If [Overload fault mgt] (OLL) is set to [Ignore] (ND), motor thermal protection is no longer provided by the drive. Provide an alternative means of thermal protection.</p> <p>Failure to follow these instructions can result in equipment damage.</p> </div> <p>Type of stop in the event of a motor thermal trip.</p> ND [Ignore] (ND): Detected fault ignored YES [Freewheel] (YES): Freewheel stop SEt [Per STT] (SEt): Stop according to configuration of [Type of stop] (SEt) page 158, without tripping. In this case, the fault relay does not open and the drive is ready to restart as soon as the detected fault disappears, according to the restart conditions of the active command channel (for example, according to [2/3 wire control] (ELC) and [2 wire type] (ELt) page 112 if control is via the terminals). Configuring an alarm for this detected fault is recommended (assigned to a logic output, for example) in order to indicate the cause of the stop. LFf [fallback spd] (LFf): Change to fallback speed, maintained as long as the detected fault persists and the run command has not been removed (2) rLs [Spd maint.] (rLs): The drive maintains the speed being applied when the detected fault occurred, as long as the detected fault is present and the run command has not been removed (2) rPP [Ramp stop] (rPP): Stop on ramp FSt [Fast stop] (FSt): Fast stop dCI [DC injection] (dCI): DC injection stop. This type of stop cannot be used with certain other functions. See table on page 150 | | [Freewheel] (YES) |
| TEt | [Mot THR memo] Motor thermal state memorization. | | [No] (ND) |
| | ND [No] (ND): Motor thermal state is not stored at power off YES [Yes] (YES): Motor thermal state is stored at power off | | |

Parameters described in this page can be accessed by:

DRI- > CONF > FULL > FLT-> OPL-

| Code | Name / Description | Adjustment range | Factory setting |
|--|--|------------------|---------------------------|
| <i>FLt -</i> | [FAULT MANAGEMENT] (continued) | | |
| <i>OPL -</i> | [OUTPUT PHASE LOSS] | | |
| <i>OPL</i>  2 s | <p>[Output Phase Loss]</p> <div style="border: 1px solid black; padding: 5px; text-align: center;"> <p>⚠ DANGER</p> <p>HAZARD OF ELECTRIC SHOCK, EXPLOSION, OR ARC FLASH</p> <p>If [Output phase loss] (OPL) is set to [No] (nD) or [Output cut] (OAC), loss of cable is not detected. Check this action will not endanger personnel or equipment in any way. Failure to follow these instructions will result in death or serious injury.</p> </div> <p>Note: [Output phase loss] (OPL) is set to [No] (nD) when [Motor control type] (CLL) page 92 is set to [Sync. mot.] (SYN). For other [Motor control type] (CLL) configurations, [Output phase loss] (OPL) is forced to [Yes] (YES) if brake logic control is configured.</p> <p><i>nD</i> [No] (nD): Function inactive <i>YES</i> [Yes] (YES): Tripping on [Output phase loss] (OPL) with freewheel stop <i>OAC</i> [Output cut] (OAC): No fault triggered, but management of the output voltage in order to avoid an overcurrent when the link with the motor is re-established and catch on the fly performed (even if this function has not been configured). The drive switches to [Output cut] (SOC) state after [OutPh time detect] (ODE) time. Catch on fly is possible as soon as the drive is in Stand by output cut [Output cut] (SOC) state.</p> | | [Yes] (YES) |
| <i>ODE</i>  | <p>[OutPh time detect]</p> <p>Time delay for taking the [Output Phase Loss] (OPL) detected fault into account.</p> | 0.5 to 10 s | 0.5 s |
| <i>FLt -</i> | [FAULT MANAGEMENT] (continued) | | |
| <i>IPL -</i> | [INPUT PHASE LOSS] | | |
| <i>IPL</i>   2 s | <p>[Input phase loss]</p> <p>Cannot be accessed if drive rating is ATV●●●M2. In this case, no factory settings value. Factory setting : [Freewheel] (YES) for drive rating ATV32●●●N4. If 1 phase disappears and if this leads to performance decrease, the drive switches to fault mode [Input phase loss] (PFH). If 2 or 3 phases disappear, the drive trips in [Input phase loss] (PFH).</p> <p><i>nD</i> [Ignore] (nD): Detected fault ignored <i>YES</i> [Freewheel] (YES): Detected fault with freewheel stop</p> | | According to drive rating |

| Code | Name / Description | Adjustment range | Factory setting |
|---|---|------------------|--------------------------|
| FLT - | [FAULT MANAGEMENT] (continued) | | |
| OHL - | [DRIVE OVERHEAT] | | |
| OHL | [Overtemp fault mgt] | | [Freewheel] (YES) |
| | <div style="border: 1px solid black; padding: 10px;"> <p style="font-size: 24px; margin: 0;">⚠ CAUTION</p> <p>RISK OF EQUIPMENT DAMAGE Inhibiting drive overheating fault detection results in the drive not being protected. This invalidates the warranty. Check that the possible consequences do not present any risk. Failure to follow these instructions can result in injury or equipment damage.</p> </div> | | |
| | Behavior in the event of the drive overheating. Note: A trip will occur when the thermal state reaches 118% of the rated state and reactivation will occur when the state falls back below 90%. | | |
| nD | [Ignore] (nD): Detected fault ignored | | |
| YES | [Freewheel] (YES): Freewheel stop | | |
| SEt | [Per STT] (SEt): Stop according to configuration of [Type of stop] (SEt) page 158, without tripping. In this case, the fault relay does not open and the drive is ready to restart as soon as the detected fault disappears, according to the restart conditions of the active command channel (for example, according to [2/3 wire control] (EEt) and [2 wire type] (EEt) page 112 if control is via the terminals). Configuring an alarm for this detected fault is recommended (assigned to a logic output, for example) in order to indicate the cause of the stop. | | |
| LFf | [fallback spd] (LFf): Change to fallback speed, maintained as long as the detected fault persists and the run command has not been removed (2) | | |
| rLs | [Spd maint.] (rLs): The drive maintains the speed being applied when the detected fault occurred, as long as the detected fault is present and the run command has not been removed (2) | | |
| rPP | [Ramp stop] (rPP): Stop on ramp | | |
| FSt | [Fast stop] (FSt): Fast stop | | |
| dCI | [DC injection] (dCI): DC injection stop. This type of stop cannot be used with certain other functions. See table on page 148 | | |
| EHt | [Drv therm. state al] | 0 to 118% | 100% |
|  | Trip threshold for drive thermal alarm (logic output or relay). | | |

- (1) The parameter can also be accessed in the **[SETTINGS] (SEt -)** menu.
- (2) Because, in this case, the detected fault does not trigger a stop, it is recommended to assign a relay or logic output to its indication.

 These parameters only appear if the corresponding function has been selected in another menu. When the parameters can also be accessed and adjusted from within the configuration menu for the corresponding function, their description is detailed in these menus, on the pages indicated, to aid programming.

 Parameter that can be modified during operation or when stopped.

 2 s To change the assignment of this parameter, press the ENT key for 2 s.

Parameters described in this page can be accessed by:

DRI- > CONF > FULL > FLT- > SAT-

Deferred stop on thermal alarm

This function helps to prevent the drive stopping between two steps of the process if the drive or motor overheats, by authorizing operation until the next stop. At the next stop, the drive is locked until the thermal state falls back to a value, which undershoots the set threshold by 20%. Example: A trip threshold set at 80% enables reactivation at 60%.

One thermal state threshold must be defined for the drive, and one thermal state threshold for the motor(s), which will trip the deferred stop.

| Code | Name / Description | Adjustment range | Factory setting |
|---------------------|--|------------------|----------------------------|
| FLT - | [FAULT MANAGEMENT] (continued) | | |
| SAT - | [THERMAL ALARM STOP] | | |
| SAT | [Thermal alarm stop] | | [No] (nD) |
| | Thermal alarm stop function allow to set a custom alarm thermal level for the drive or the motor. When one of these levels is reached, the drive trips in freewheel stop. | | |
| | nD [No] (nD): Function inactive (in this case, the following parameters cannot be accessed) YES [Yes] (YES): Freewheel stop on drive or motor thermal alarm | | |
| EHF () | [Drv therm. state al] | 0 to 118% | 100% |
| | Thermal state threshold of the drive tripping the deferred stop. | | |
| EE d () | [Motor therm. level] | 0 to 118% | 100% |
| | Thermal state threshold of the motor tripping the deferred stop. | | |
| EE d2 () | [Motor2 therm. level] | 0 to 118% | 100% |
| | Thermal state threshold of the motor 2 tripping the deferred stop. | | |
| EE d3 () | [Motor3 therm. level] | 0 to 118% | 100% |
| | Thermal state threshold of the motor 3 tripping the deferred stop. | | |
| FLT - | [FAULT MANAGEMENT] (continued) | | |
| EEF - | [EXTERNAL FAULT] | | |
| EEF | [External fault ass.] | | [No] (nD) |
| | If the assigned bit is at 0, there is no external fault. If the assigned bit is at 1, there is an external fault. Logic can be configured via [External fault config] (LEE) if a logic input has been assigned. | | |
| | nD [No] (nD): Function inactive LI [LI] (LI): Logical input LI1 [...] (. . .): See the assignment conditions on page 138 | | |
| LEE ★ | [External fault config] | | [Active high] (HIG) |
| | Parameter can be accessed if the external fault has been assigned to a logic input. It defines the positive or negative logic of the input assigned to the detected fault. | | |
| | LD [Active low] (LD): Trip on falling edge (change from 1 to 0) of the assigned input HIG [Active high] (HIG): Trip on rising edge (change from 0 to 1) of the assigned input | | |

Parameters described in this page can be accessed by: DRI- > CONF > FULL > FLT- > ETF-

| Code | Name / Description | Adjustment range | Factory setting |
|----------------|--|-----------------------------------|-----------------------------------|
| E P L | [External fault mgt] Type of stop in the event of an external fault. | | [Freewheel] (Y E 5) |
| <i>n 0</i> | [Ignore] (n 0) : External fault ignored | | |
| <i>Y E 5</i> | [Freewheel] (Y E 5) : Freewheel stop | | |
| <i>S E E</i> | [Per STT] (S E E) : Stop according to configuration of [Type of stop] (S E E) page 158, without tripping. In this case, the fault relay does not open and the drive is ready to restart as soon as the detected fault disappears, according to the restart conditions of the active command channel (for example, according to [2/3 wire control] (E C C) and [2 wire type] (E C E) page 112 if control is via the terminals). Configuring an alarm for this detected fault is recommended (assigned to a logic output, for example) in order to indicate the cause of the stop. | | |
| <i>L F F</i> | [fallback spd] (L F F) : Change to fallback speed, maintained as long as the detected fault persists and the run command has not been removed (1) | | |
| <i>r L S</i> | [Spd maint.] (r L S) : The drive maintains the speed being applied when the detected fault occurred, as long as the detected fault is present and the run command has not been removed (1) | | |
| <i>r P P</i> | [Ramp stop] (r P P) : Stop on ramp | | |
| <i>F S E</i> | [Fast stop] (F S E) : Fast stop | | |
| <i>d C I</i> | [DC injection] (d C I) : DC injection stop. This type of stop cannot be used with certain other functions. See table on page 150 | | |
| F L E - | [FAULT MANAGEMENT] (continued) | | |
| U S b - | [UNDERVOLTAGE MGT] | | |
| U S b | [UnderV. fault mgt] Behavior of the drive in the event of an undervoltage. | | [Std fault] (0) |
| <i>0</i> | [Std fault] (0) : The drive trips and the external fault signal is triggered (the fault relay assigned to [No drive flt] (F L E) will be opened) | | |
| <i>1</i> | [Flt wo relay] (1) : The drive trips but the external fault signal is not triggered (the fault relay assigned to [No drive flt] (F L E) remains closed) | | |
| <i>2</i> | [Alarm] (2) : Alarm and fault relay remain closed. The alarm can be assigned to a logic output or a relay | | |
| U r E S | [Mains voltage] Rated voltage of the line supply in V. | According to drive voltage rating | According to drive voltage rating |
| | For ATV32●●●M2: <i>2 0 0</i> [200V ac] (2 0 0) : 200 Volts AC <i>2 2 0</i> [220V ac] (2 2 0) : 220 Volts AC <i>2 3 0</i> [230V ac] (2 3 0) : 230 Volts AC <i>2 4 0</i> [240V ac] (2 4 0) : 240 Volts AC For ATV32●●●N4: <i>3 8 0</i> [380V ac] (3 8 0) : 380 Volts AC <i>4 0 0</i> [400V ac] (4 0 0) : 400 Volts AC <i>4 4 0</i> [440V ac] (4 4 0) : 440 Volts AC <i>4 6 0</i> [460V ac] (4 6 0) : 460 Volts AC <i>5 0 0</i> [500V ac] (5 0 0) : 500 Volts AC (factory setting) | | |
| U S L | [Undervoltage level] Undervoltage fault level setting in Volts. The factory setting is determined by the drive voltage rating. | 100 to 276 V | According to drive rating |
| U S E | [Undervolt. time out] Time delay for taking undervoltage detected fault into account. | 0.2 s to 999.9 s | 0.2 s |
| S E P | [UnderV. prevention] Behavior in the event of the undervoltage prevention level being reached. | | [No] (n 0) |
| <i>n 0</i> | [No] (n 0) : No action | | |
| <i>n n S</i> | [DC Maintain] (n n S) : This stop mode uses the inertia to maintain the DC bus voltage as long as possible | | |
| <i>r P P</i> | [Ramp stop] (r P P) : Stop following an adjustable ramp [Max stop time] (S E P) | | |
| <i>L n F</i> | [Lock-out] (L n F) : Lock (freewheel stop) without trip | | |
| E S P | [UnderV. restart tm] Time delay before authorizing the restart after a complete stop for [UnderV. prevention] (S E P) = [Ramp stop] (r P P) , if the voltage has returned to normal. | 1.0 s to 999.9 s | 1.0 s |
| ★ ↻ | | | |

Parameters described in this page can be accessed by:

DRI- > CONF > FULL > FLT- > USB-

| Code | Name / Description | Adjustment range | Factory setting |
|--|--|------------------|--------------------------------|
| UPL ★ | [Prevention level] Undervoltage prevention level setting in Volts, which can be accessed if [UnderV. prevention] (SE P) is not [No] (n D). The adjustment range and factory setting are determined by the drive voltage rating and the [Mains voltage] (U r E S) value. | 133 to 261 V | According to drive rating |
| SE Π ★ () | [Max stop time] Ramp time if [UnderV. prevention] (SE P) is set to [Ramp stop] (r Π P). | 0.01 to 60.00 s | 1.00 s |
| EB S ★ () | [DC bus maintain tm] DC bus maintain time if [UnderV. prevention] (SE P) is set to [DC Maintain] (Π Π S). | 1 to 9,999 s | 9,999 s |
| FL E - | [FAULT MANAGEMENT] (continued) | | |
| E I E - | [IGBT TESTS] | | |
| SE r E n D YES | [IGBT test] [No] (n D): No test [Yes] (YES): The IGBTs are tested on power up and every time a run command is sent. These tests cause a slight delay (a few ms). In the event of a detected fault, the drive will lock. The following faults can be detected: - Drive output short-circuit (terminals U-V-W): SCF display. - IGBT inoperable: xF, where x indicates the number of the IGBT concerned. - IGBT short-circuited: x2F, where x indicates the number of the IGBT concerned. | | [No] (n D) |
| FL E - | [FAULT MANAGEMENT] (continued) | | |
| L FL - | [4-20mA LOSS] | | |
| L FL E n D YES SE E L F F r L S r Π P F S E d C I | [AI3 4-20mA loss] [Ignore] (n D): Detected fault ignored. This is the only possible configuration if [AI3 min. value] (E r L E) page 121 is not greater than 3 mA [Freewheel] (YES): Freewheel stop [Per STT] (SE E): Stop according to configuration of [Type of stop] (SE E) page 158 , without fault tripping. In this case, the fault relay does not open and the drive is ready to restart as soon as the detected fault disappears, according to the restart conditions of the active command channel (for example, according to [2/3 wire control] (E C C) and [2 wire type] (E C E) page 112 if control is via the terminals). Configuring an alarm for this detected fault is recommended (assigned to a logic output, for example) in order to indicate the cause of the stop [Fallback spd] (L F F): Change to fallback speed, maintained as long as the detected fault persists and the run command has not been removed (1) [Spd maint.] (r L S): The drive maintains the speed being applied when the detected fault occurred, as long as the detected fault is present and the run command has not been removed (1) [Ramp stop] (r Π P): Stop on ramp [Fast stop] (F S E): Fast stop [DC injection] (d C I): DC injection stop. This type of stop cannot be used with certain other functions. See table on page 148 | | [Ignore] (n D) |

(1) Because, in this case, the detected fault does not trigger a stop, it is recommended to assign a relay or logic output to its indication.



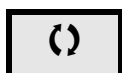

These parameters only appear if the corresponding function has been selected in another menu. When the parameters can also be accessed and adjusted from within the configuration menu for the corresponding function, their description is detailed in these menus, on the pages indicated, to aid programming.



Parameter that can be modified during operation or when stopped.

Parameters described in this page can be accessed by:

DRI- > CONF > FULL > FLT- > CLL-

| Code | Name / Description | Adjustment range | Factory setting |
|--------------|--|------------------|----------------------------|
| C D L | [CANopen fault mgt] | | [Freewheel] (Y E S) |
| |  WARNING | | |
| | <p>LOSS OF CONTROL If CANopen® fault management [Unld. Thr. 0. Speed.] (C D L) is set to [Ignore] (n D), communication control will be inhibited. For safety reasons, inhibiting the communication interruption detection should be restricted to the debug phase or to special applications. Failure to follow these instructions can result in death, serious injury, or equipment damage.</p> | | |
| | Behavior of the drive in the event of a communication interruption with integrated CANopen®. | | |
| n D | [Ignore] (n D) : Detected fault ignored | | |
| Y E S | [Freewheel] (Y E S) : Freewheel stop | | |
| S E E | [Per STT] (S E E) : Stop according to configuration of [Type of stop] (S E E) page 158, without fault tripping. In this case, the fault relay does not open and the drive is ready to restart as soon as the detected fault disappears, according to the restart conditions of the active command channel (for example, according to [2/3 wire control] (E C C) and [2 wire type] (E C E) page 112 if control is via the terminals). Configuring an alarm for this detected fault is recommended (assigned to a logic output, for example) in order to indicate the cause of the stop. | | |
| L F F | [fallback spd] (L F F) : Change to fallback speed, maintained as long as the detected fault persists and the run command has not been removed (1) | | |
| r L S | [Spd maint.] (r L S) : The drive maintains the speed being applied when the detected fault occurred, as long as the detected fault is present and the run command has not been removed (1) | | |
| r P P | [Ramp stop] (r P P) : Stop on ramp | | |
| F S E | [Fast stop] (F S E) : Fast stop | | |
| d C I | [DC injection] (d C I) : DC injection stop. This type of stop cannot be used with certain other functions. See table on page 150. | | |
| S L L | [Modbus fault mgt] | | [Freewheel] (Y E S) |
| |  WARNING | | |
| | <p>LOSS OF CONTROL If Modbus fault management [Modbus fault mgt] (S L L) is set to [Ignore] (n D), communication control will be inhibited. For safety reasons, inhibiting the communication interruption detection should be restricted to the debug phase or to special applications. Failure to follow these instructions can result in death, serious injury, or equipment damage.</p> | | |
| | Behavior of the drive in the event of a communication interruption with integrated Modbus. | | |
| n D | [Ignore] (n D) : Detected fault ignored | | |
| Y E S | [Freewheel] (Y E S) : Freewheel stop | | |
| S E E | [Per STT] (S E E) : Stop according to configuration of [Type of stop] (S E E) page 158, without fault tripping. In this case, the fault relay does not open and the drive is ready to restart as soon as the detected fault disappears, according to the restart conditions of the active command channel (for example, according to [2/3 wire control] (E C C) and [2 wire type] (E C E) page 112 if control is via the terminals). Configuring an alarm for this detected fault is recommended (assigned to a logic output, for example) in order to indicate the cause of the stop. | | |
| L F F | [fallback spd] (L F F) : Change to fallback speed, maintained as long as the detected fault persists and the run command has not been removed (1) | | |
| r L S | [Spd maint.] (r L S) : The drive maintains the speed being applied when the detected fault occurred, as long as the detected fault is present and the run command has not been removed (1) | | |
| r P P | [Ramp stop] (r P P) : Stop on ramp | | |
| F S E | [Fast stop] (F S E) : Fast stop | | |
| d C I | [DC injection] (d C I) : DC injection stop. This type of stop cannot be used with certain other functions. See table on page 150. | | |

Parameters described in this page can be accessed by: DRI- > CONF > FULL > FLT- > TID-

| Code | Name / Description | Adjustment range | Factory setting |
|-------------|---|------------------|----------------------|
| FLt- | [FAULT MANAGEMENT] (continued) | | |
| tId- | [TORQUE OR LIM. DETECT] | | |
| SSb | [Trq/l limit. stop] Behavior in the event of switching to torque or current limitation. | | [Ignore] (nD) |
| nD | [Ignore] (nD) : Detected fault ignored | | |
| YEs | [Freewheel] (YEs) : Freewheel stop | | |
| Stt | [Per STT] (Stt) : Stop according to configuration of [Type of stop] (Stt) page 158, without fault tripping. In this case, the fault relay does not open and the drive is ready to restart as soon as the detected fault disappears, according to the restart conditions of the active command channel (for example, according to [2/3 wire control] (tcc) and [2 wire type] (tct) page 112 if control is via the terminals). Configuring an alarm for this detected fault is recommended (assigned to a logic output, for example) in order to indicate the cause of the stop | | |
| LFf | [fallback spd] (LFf) : Change to fallback speed, maintained as long as the detected fault persists and the run command has not been removed (1) | | |
| rLs | [Spd maint.] (rLs) : The drive maintains the speed being applied when the detected fault occurred, as long as the detected fault is present and the run command has not been removed (1) | | |
| rPP | [Ramp stop] (rPP) : Stop on ramp | | |
| FSt | [Fast stop] (FSt) : Fast stop | | |
| dCI | [DC injection] (dCI) : DC injection stop. This type of stop cannot be used with certain other functions. See table on page 150 | | |
| StD | [Trq/l limit. time out] (If trip has been configured) Time delay for taking SSF limitation into account. | 0 to 9,999 ms | 1,000 ms |

(1) Because, in this case, the detected fault does not trigger a stop, it is recommended to assign a relay or logic output to its indication.



These parameters only appear if the corresponding function has been selected in another menu. When the parameters can also be accessed and adjusted from within the configuration menu for the corresponding function, their description is detailed in these menus, on the pages indicated, to aid programming.

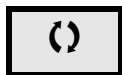

Parameter that can be modified during operation or when stopped.



To change the assignment of this parameter, press the ENT key for 2 s.

Use of the "Pulse input" input to measure the speed of rotation of the motor

This function uses the "Pulse input" input and can only be used if the "Pulse input" input is not being used for another function.

Example of use

An indexed disk driven by the motor and connected to a proximity sensor can be used to generate a frequency signal that is proportional to the speed of rotation of the motor.

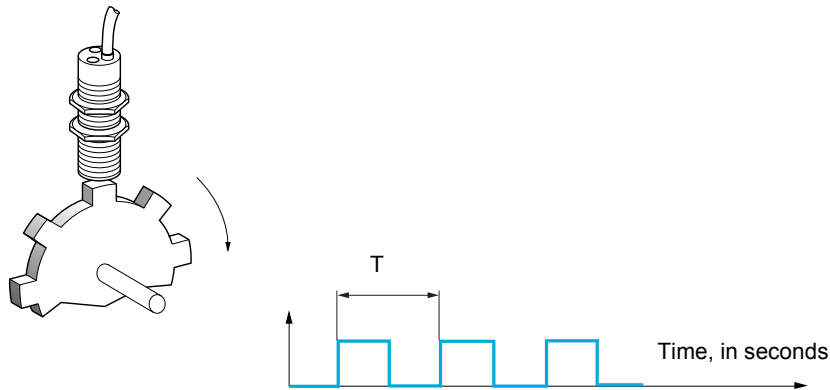

When applied to the "Pulse input" input, this signal supports:

- Measurement and display of the motor speed: signal frequency = $1/T$. This frequency is displayed by means of the **[Pulse in. work. freq.] (F 95)** parameter, page [44](#).
- Overspeed detection (if the measured speed exceeds a preset threshold, the drive will trip).
- Brake failure detection, if brake logic control has been configured: If the speed does not drop sufficiently quickly following a command to engage the brake, the drive will trip. This function can be used to detect worn brake linings.
- Detection of a speed threshold that can be adjusted using **[Pulse warning thd.] (F 9L)** page [89](#) and is assignable to a relay or logic output, see page [123](#).

| Code | Name / Description | Adjustment range | Factory setting |
|----------------------------|--|------------------|-------------------|
| F L t - | [FAULT MANAGEMENT] (continued) | | |
| F 9 F - | [FREQUENCY METER] | | |
| F 9 F | [Frequency meter] Activation of the speed measurement function. | | [No] (n 0) |
| n 0 4 E 5 | [No] (n 0): Function inactive. In this case, none of the function parameters can be accessed [Yes] (4 E 5): Function active, assignment only possible if no other functions have been assigned to the "Pulse input" input | | |
| F 9 C () | [Pulse scal. divisor] Scaling factor for the "Pulse input" input (divisor). The frequency measured is displayed by means of the [Pulse in. work. freq.] (F 9 5) parameter, page 44 . | 1.0 to 100.0 | 1.0 |
| F 9 R | [Overspd. pulse thd.] Activation and adjustment of overspeed monitoring: [Overspeed] (5 0 F) . | | [No] (n 0) |
| n 0 - | [No] (n 0): No overspeed monitoring 1 Hz to 20.00 kHz: Adjustment of the frequency tripping threshold on the "Pulse input" input divided by [Pulse scal. divisor] (F 9 C) . | | |
| t d 5 | [Pulse overspd delay] Time delay for taking overspeed detected fault into account. | 0.0 s to 10.0 s | 0.0 s |
| F d t | [Level fr. pulse ctrl] Activation and adjustment of monitoring for the Pulse input (speed feedback): [Speed fdbck loss] (5 P F) . | | [No] (n 0) |
| n 0 - | [No] (n 0): No monitoring of speed feedback 0.1 Hz to 599 Hz: Adjustment of the motor frequency threshold for tripping a speed feedback detected fault (difference between the estimated frequency and the measured speed). | | |
| F 9 t | [Pulse thd. wo Run] Activation and adjustment of brake failure monitoring: [Brake feedback] (b r F) . If brake logic control [Brake] (b L C) page 179 is not configured, this parameter is forced to [No] (n 0) . | | [No] (n 0) |
| n 0 - | [No] (n 0): No brake monitoring 1 Hz to 1,000 Hz: Adjustment of the motor frequency threshold for tripping a brake failure trip (detection of speeds other than 0). | | |
| t 9 b | [Pulse wo Run delay] Time delay for taking brake failure trip into account. | 0.0 s to 10.0 s | 0.0 s |

Parameters described in this page can be accessed by:

DRI- > CONF > FULL > FLT- > DLD-

Load variation detection

This detection is only possible with the High-speed hoisting function. It can be used to detect if an obstacle has been reached, triggering a sudden (upward) increase or (downward) decrease in the load.

Load variation detection triggers a **[Dynamic load fault] (d L F)**. The **[Dyn. load Mgt.] (d L b)** parameter can be used to configure the response of the drive in the event of this detected fault.

Load variation detection can also be assigned to a relay or a logic output.

There are two possible detection modes, depending on the configuration of high-speed hoisting:

- Speed reference mode
[High speed hoisting] (H S D) page [190](#) is set to **[Speed ref] (S S D)**.
 Torque variation detection.
 During high-speed operation, the load is compared to that measured during the speed step. The permissible load variation and its duration can be configured. If exceeded, the drive switches to fault mode.
- Current limitation mode
[High speed hoisting] (H S D) page [190](#) is set to **[Current Limit] (C S D)**.
 On ascend, during high-speed operation, an increase in load will result in a drop in speed. Even if high-speed operation has been activated, if the motor frequency drops below the **[I Limit Frequency] (S C L)** threshold page [190](#), the drive will switch to fault mode. The detection is realised only for a positive variation of the load and only in the high speed area (area upper to **[I Limit Frequency] (S C L)**).
 On descend, operation takes the form of Speed reference mode.

| Code | Name / Description | Adjustment range | Factory setting |
|-----------------|---|------------------|----------------------------|
| F L t - | [FAULT MANAGEMENT] (continued) | | |
| d L d - | [DYNAMIC LOAD DETECT.] Load variation detection. This can be accessed if [High speed hoisting] (H S D) page 190 is not [No] (n D) . | | |
| t L d | [Dynamic load time] Activation of load variation detection and adjustment of time delay for taking load variation detected fault [Dynamic load fault] (d L F) into account. | | [No] (n D) |
| n D - | [No] (n D) : No load variation detection 0.00 s to 10.00 s : Adjustment of the time delay for taking detected fault into account. | | |
| d L d | [Dynamic load threshold] Adjustment of the trip threshold for load variation detection, as a % of the load measured during the speed step. | 1 to 100% | 100% |
| d L b | [Dyn. load Mgt.] Behavior of the drive in the event of a load variation detected fault. | | [Freewheel] (Y E S) |
| n D | [Ignore] (n D) : Detected fault ignored | | |
| Y E S | [Freewheel] (Y E S) : Freewheel stop | | |
| S t t | [Per STT] (S t t) : Stop according to configuration of [Type of stop] (S t t) page 158 , without tripping. In this case, the fault relay does not open and the drive is ready to restart as soon as the detected fault disappears, according to the restart conditions of the active command channel, (for example, according to [2/3 wire control] (t C C) and [2 wire type] (t C t) page 112 if control is via the terminals). Configuring an alarm for this detected fault is recommended (assigned to a logic output, for example) in order to indicate the cause of the stop | | |
| L F F | [Fallback spd.] (L F F) : Change to fallback speed, maintained as long as the detected fault persists and the run command has not been removed (1) | | |
| r L S | [Spd maint.] (r L S) : The drive maintains the speed at the time the detected fault occurred, as long as the detected fault persists and the run command has not been removed (1) | | |
| r P P | [Ramp stop] (r P P) : Stop on ramp | | |
| F S t | [Fast stop] (F S t) : Fast stop | | |

Parameters described in this page can be accessed by:

DRI- > CONF > FULL > FLT- > TNF-

| Code | Name / Description | Adjustment range | Factory setting |
|----------------|---|------------------|--------------------------|
| <i>FLt-</i> | [FAULT MANAGEMENT] (continued) | | |
| <i>t n F -</i> | [AUTO TUNING FAULT] | | |
| <i>t n L</i> | [Autotune fault mgt] | | [Freewheel] (YES) |
| | <i>n 0</i> [Ignore] (n 0) : Detected fault ignored | | |
| | <i>YES</i> [Freewheel] (YES) : Freewheel stop | | |

(1) Because, in this case, the detected fault does not trigger a stop, it is recommended to assign a relay or logic output to its indication.



These parameters only appear if the corresponding function has been selected in another menu. When the parameters can also be accessed and adjusted from within the configuration menu for the corresponding function, their description is detailed in these menus, on the pages indicated, to aid programming.



Parameter that can be modified during operation or when stopped.

Parameters described in this page can be accessed by:

DRI- > CONF > FULL > FLT- > PPI-

Card pairing

Function can only be accessed in **[Expert] (E P r)** mode.

This function is used to detect whenever a card has been replaced or the software has been modified in any way.

When a pairing password is entered, the parameters of the card currently inserted are stored. On every subsequent power-up, these parameters are verified and, in the event of a discrepancy, the drive locks in HCF fault mode. Before the drive can be restarted, you must revert to the original situation or re-enter the pairing password.

The following parameters are verified:

- The type of card for: all cards.
- The software version for: the control block, the communication cards.
- The serial number for: the control block.

| Code | Name / Description | Adjustment range | Factory setting |
|-----------------|---|-----------------------------|--------------------|
| <i>FLT-</i> | [FAULT MANAGEMENT] (continued) | | |
| <i>PPI-</i> | [CARDS PAIRING] | | |
| <i>PPI</i> ★ | [Pairing password] | [OFF] (OFF) to 9,999 | [OFF] (OFF) |
| <i>OFF</i> - | <p>The [OFF] (OFF) value signifies that the card pairing function is inactive</p> <p>The [ON] (On) value signifies that card pairing is active and that an access code must be entered in order to start the drive in the event of a card pairing detected fault</p> <p>As soon as the code has been entered, the drive is unlocked and the code changes to [ON] (On).</p> <p>The PPI code is an unlock code known only to Schneider Electric Product Support.</p> | | |



These parameters only appear if the corresponding function has been selected in another menu. When the parameters can also be accessed and adjusted from within the configuration menu for the corresponding function, their description is detailed in these menus, on the pages indicated, to aid programming.

Process underload detected fault

A process underload is detected when the next event occurs and remains pending for a minimum time **[Unld Time Detect.] (ULt)**, which is configurable:

- The motor is in steady state and the torque is below the set underload limit (**[Unld. Thr. 0. Speed.] (LUL)**, **[Unld. Thr. Nom. Speed.] (LUn)**, **[Unld. Freq. Thr. Det.] (rNUd)** parameters).
- The motor is in steady state when the offset between the frequency reference and motor frequency falls below the configurable threshold **[Hysteresis Freq. Att.] (Srb)**.

Torque as a % of the rated torque

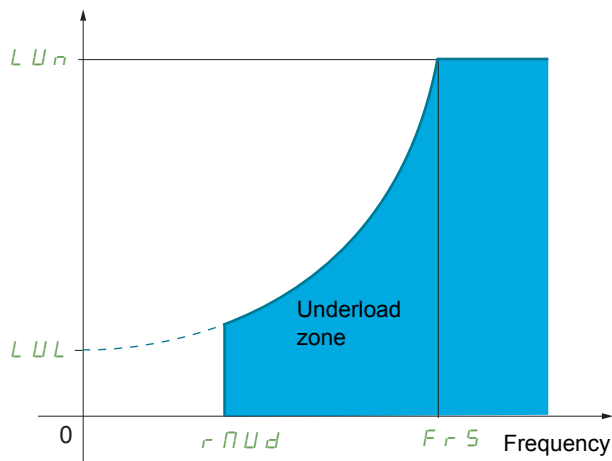

Between zero frequency and the rated frequency, the curve reflects the following equation:

$$\text{torque} = LUL + \frac{(LUn - LUL) \times (\text{frequency})^2}{(\text{rated frequency})^2}$$

The underload function is not active for frequencies below **[Unld. Freq. Thr. Det.] (rNUd)**.

A relay or a logic output can be assigned to the signaling of this detected fault in the **[INPUTS / OUTPUTS CFG] (I-O-)** menu.

| Code | Name / Description | Adjustment range | Factory setting |
|-------------------------|--|--|-----------------|
| FLt- | [FAULT MANAGEMENT] (continued) | | |
| ULd- | [PROCESS UNDERLOAD] | | |
| ULt | [Unld T. Del. Detect.] Underload detection time delay. A value of 0 deactivates the function and makes the other parameters inaccessible. | 0 to 100 s | 0 s |
| LUn ★ () | [Unld. Thr. Nom. Speed.] Underload threshold at rated motor frequency ([Rated motor freq.] (Fr5) page 74), as a % of the rated motor torque. | 20 to 100% | 60% |
| LUL ★ () | [Unld. Thr. 0. Speed.] Underload threshold at zero frequency, as a % of the rated motor torque. | 0 to [Unld.Thr.Nom.Speed] (LUn) | 0% |
| rNUd ★ () | [Unld. Freq. Thr. Det.] Minimum frequency underload detection threshold. | 0 to 599 Hz | 0 Hz |
| Srb ★ () | [Hysteresis Freq. Att.] Maximum deviation between the frequency reference and the motor frequency, which defines steady state operation. | 0.3 to 599 Hz | 0.3 Hz |

Parameters described in this page can be accessed by: DRI- > CONF > FULL > FLT- > ULD-

| Code | Name / Description | Adjustment range | Factory setting |
|--------------------------|--|------------------|---------------------|
| U d L ★ | [Underload Managmt.] Behavior on switching to underload detection. n D [Ignore] (n D): Detected fault ignored Y E S [Freewheel] (Y E S): Freewheel stop r P P [Ramp stop] (r P P): Stop on ramp F S t [Fast stop] (F S t): Fast stop | | [Freewheel] (Y E S) |
| F t U ★ (↻) | [Underload T.B. Rest.] This parameter cannot be accessed if [Underload Mangmt.] (U d L) is set to [Ignore] (n D). Minimum time permitted between an underload being detected and any automatic restart. In order to allow an automatic restart, the value of [Max. restart time] (t P r) page 234 must exceed this parameter by at least one minute. | 0 to 6 min | 0 min |

★ These parameters only appear if the corresponding function has been selected in another menu. When the parameters can also be accessed and adjusted from within the configuration menu for the corresponding function, their description is detailed in these menus, on the pages indicated, to aid programming.

(↻) Parameter that can be modified during operation or when stopped.

Process overload detected fault

A process overload is detected when the next event occurs and remains pending for a minimum time **[Ovld Time Detect.] (tDL)**, which is configurable:

- The drive is in current limitation mode.
- The motor is in steady state and the current is above the set overload threshold **[Ovld Detection Thr.] (LOC)**.

The motor is in steady state when the offset between the frequency reference and motor frequency falls below the configurable threshold **[Hysteresis Freq. Att.] (Srb)**.

A relay or a logic output can be assigned to the signaling of this detected fault in the **[INPUTS / OUTPUTS CFG] (I-D-)** menu.

| Code | Name / Description | Adjustment range | Factory setting |
|------------------------|--|------------------|--------------------------|
| FLt- | [FAULT MANAGEMENT] (continued) | | |
| OLd- | [PROCESS OVERLOAD] | | |
| tDL | [Ovld Time Detect.] Overload detection time delay. A value of 0 deactivates the function and makes the other parameters inaccessible. | 0 to 100 s | 0 s |
| LOC ★ (1) | [Ovld Detection Thr.] Overload detection threshold, as a % of the rated motor current [Rated mot. current] (nCr) page 74. This value must be less than the limit current in order for the function to work. | 70 to 150% | 110% |
| Srb ★ (1) | [Hysteresis Freq.Att.] Maximum deviation between the frequency reference and the motor frequency, which defines steady state operation. | 0 to 599 Hz | 0.3 Hz |
| DDL ★ | [Ovld.Proces.Mngmt] Behavior on switching to overload detection. nD [Ignore] (nD) : Detected fault ignored YES [Freewheel] (YES) : Freewheel stop rPP [Ramp stop] (rPP) : Stop on ramp FSt [Fast stop] (FSt) : Fast stop | | [Freewheel] (YES) |
| FtD ★ (1) | [Overload T.B.Rest.] This parameter cannot be accessed if [Ovld.Proces.Mngmt] (DDL) is set to [Ignore] (nD) . Minimum time permitted between an overload being detected and any automatic restart. In order to allow an automatic restart, the value of [Max. restart time] (tRr) page 234 must exceed this parameter by at least one minute. | 0 to 6 min | 0 min |
| FLt- | [FAULT MANAGEMENT] (continued) | | |
| LFF- | [FALLBACK SPEED] | | |
| LFF | [Fallback speed] Selection of the fallback speed. | 0 to 599 Hz | 0 Hz |



Parameters described in this page can be accessed by:

DRI- > CONF > FULL > FLT- > FST-

| Code | Name / Description | Adjustment range | Factory setting |
|----------------|--|--|-----------------|
| <i>F L E -</i> | [FAULT MANAGEMENT] (continued) | | |
| <i>F S E -</i> | [RAMP DIVIDER] | | |
| <i>d E F</i> | [Ramp divider] | 0 to 10 | 4 |
| ★ (1) | The ramp that is enabled ([Deceleration] (<i>d E C</i>) or [Deceleration 2] (<i>d E 2</i>)) is then divided by this coefficient when stop requests are sent. Value 0 corresponds to a minimum ramp time. | | |
| <i>F L E -</i> | [FAULT MANAGEMENT] (continued) | | |
| <i>d C I -</i> | [DC INJECTION] | | |
| <i>I d C</i> | [DC inject. level 1] | 0.1 to 1.41 In (2) | 0.64 In (2) |
| ★ (1) (3) | <div style="border: 1px solid black; padding: 5px; text-align: center;"> CAUTION </div> <div style="border: 1px solid black; padding: 5px;"> RISK OF DAMAGE TO THE MOTOR Check that the motor will withstand this current without overheating. Failure to follow these instructions can result in equipment damage. </div> <p>Level of DC injection braking current activated via logic input or selected as stop mode.</p> | | |
| <i>E d I</i> | [DC injection time 1] | 0.1 to 30 s | 0.5 s |
| ★ (1) (3) | <div style="border: 1px solid black; padding: 5px; text-align: center;"> CAUTION </div> <div style="border: 1px solid black; padding: 5px;"> RISK OF DAMAGE TO THE MOTOR <ul style="list-style-type: none"> • Long periods of DC injection braking can cause overheating and damage the motor. • Protect the motor by avoiding long periods of DC injection braking. Failure to follow these instructions can result in equipment damage. </div> <p>Maximum current injection time [DC inject. level 1] (<i>I d C</i>). After this time, the injection current becomes [DC inject. level 2] (<i>I d C 2</i>).</p> | | |
| <i>I d C 2</i> | [DC inject. level 2] | 0.1 In (2) to [DC inject. level 1] (<i>I d C</i>) | 0.5 In (2) |
| ★ (1) (3) | <div style="border: 1px solid black; padding: 5px; text-align: center;"> CAUTION </div> <div style="border: 1px solid black; padding: 5px;"> RISK OF DAMAGE TO THE MOTOR Check that the motor will withstand this current without overheating. Failure to follow these instructions can result in equipment damage. </div> <p>Injection current activated by logic input or selected as stop mode, once period of time [DC injection time 1] (<i>E d I</i>) has elapsed.</p> | | |

Parameters described in this page can be accessed by:

DRI- > CONF > FULL > FLT- > DCI-

| Code | Name / Description | Adjustment range | Factory setting |
|---|--|------------------|-----------------|
| EdC | [DC injection time 2] | 0.1 to 30 s | 0.5 s |
|   (1) (3) | CAUTION RISK OF DAMAGE TO THE MOTOR • Long periods of DC injection braking can cause overheating and damage the motor. • Protect the motor by avoiding long periods of DC injection braking. Failure to follow these instructions can result in equipment damage. | | |
| | Maximum injection time [DC inject. level 2] (IdC2) for injection, selected as stop mode only. This parameter can be accessed if [Type of stop] (StE) is set to [DC injection] (dC I). | | |

- (1) The parameter can also be accessed in the **[SETTINGS]** (**SEt -**) and **[APPLICATION FUNCT.]** (**FUn -**) menus.
- (2) It corresponds to the rated drive current indicated in the Installation manual and on the drive nameplate.
- (3) These settings are independent of the **[AUTO DC INJECTION]** (**AdC -**) function.

 These parameters only appear if the corresponding function has been selected in another menu. When the parameters can also be accessed and adjusted from within the configuration menu for the corresponding function, their description is detailed in these menus, on the pages indicated, to aid programming.

 Parameter that can be modified during operation or when stopped.

Parameters described in this page can be accessed by:

DRI- > CONF > FULL > COM- > ICS-

Communication

With integrated display terminal:

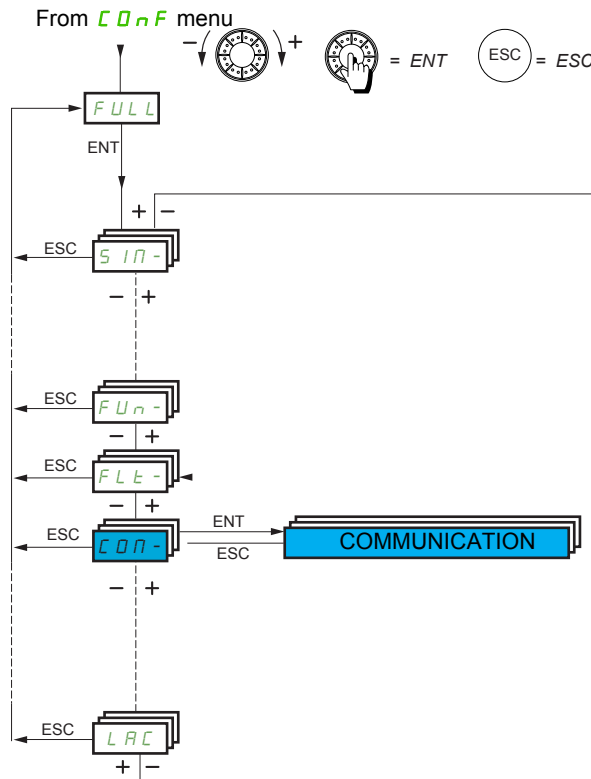

| Code | Name / Description | Adjustment range | Factory setting |
|-------------|--|------------------|-----------------|
| FULL | [FULL] (continued) | | |
| CON- | [COMMUNICATION] | | |
| ICS- | [COM. SCANNER INPUT] [Scan. IN1 address] (nPA1) to [Scan. IN4 address] (nPA4) could be used for Fast Task of the communication scanner (see Modbus & CANopen® communication manual). | | |
| nPA1 | [Scan. IN1 address] Address of the 1st input word. | | 3,201 |
| nPA2 | [Scan. IN2 address] Address of the 2nd input word. | | 8,604 |
| nPA3 | [Scan. IN3 address] Address of the 3rd input word. | | 0 |
| nPA4 | [Scan. IN4 address] Address of the 4th input word. | | 0 |
| nPA5 | [Scan. IN5 address] Address of the 5th input word. | | 0 |
| nPA6 | [Scan. IN6 address] Address of the 6th input word. | | 0 |
| nPA7 | [Scan. IN7 address] Address of the 7th input word. | | 0 |

Parameters described in this page can be accessed by: DRI- > CONF > FULL > COM- > ICS-

| Code | Name / Description | Adjustment range | Factory setting |
|--|---|---------------------------|---------------------------|
| <i>n n A B</i> | [Scan. IN8 address] Address of the 8th input word. | | 0 |
| <i>C O n -</i> | [COMMUNICATION] (continued) | | |
| <i>O C S -</i> | [COM. SCANNER OUTPUT] <i>[Scan. Puy address] (n C A 1)</i> to <i>[Scan. Out4 address] (n C A 4)</i> could be used for Fast Task of the communication scanner (see Modbus & CANopen® communication manual). | | |
| <i>n C A 1</i> | [Scan.Out1 address] Address of the 1st output word. | | 8,501 |
| <i>n C A 2</i> | [Scan.Out2 address] Address of the 2nd output word. | | 8,602 |
| <i>n C A 3</i> | [Scan.Out3 address] Address of the 3rd output word. | | 0 |
| <i>n C A 4</i> | [Scan.Out4 address] Address of the 4th output word. | | 0 |
| <i>n C A 5</i> | [Scan.Out5 address] Address of the 5th output word. | | 0 |
| <i>n C A 6</i> | [Scan.Out6 address] Address of the 6th output word. | | 0 |
| <i>n C A 7</i> | [Scan.Out7 address] Address of the 7th output word. | | 0 |
| <i>n C A 8</i> | [Scan.Out8 address] Address of the 8th output word. | | 0 |
| <i>C O n -</i> | [COMMUNICATION] (continued) | | |
| <i>n d 1 -</i> | [MODBUS NETWORK] | | |
| <i>A d d</i> <i>OFF</i> <i>-</i> | [Modbus Address] <i>[OFF] (OFF)</i> 1 to 247 | <i>[OFF] (OFF)</i> to 247 | <i>[OFF] (OFF)</i> |
| <i>A n O C</i> ★ <i>OFF</i> <i>-</i> | [Modbus add Com. C.] <i>[OFF] (OFF)</i> 1 to 247 | <i>[OFF] (OFF)</i> to 247 | <i>[OFF] (OFF)</i> |
| <i>t b r</i> | [Modbus baud rate] 4 8 - 9 6 - 19 2 - 38 4 kbps on the integrated display terminal. 4800, 9600, 19200 or 38400 bauds on the graphic display terminal. | | <i>[19.2 Kbps] (19 2)</i> |
| <i>t F O</i> | [Modbus format] 8O1 - 8E1 - 8n1, 8n2 | | <i>[8-E-1] (BE 1)</i> |
| <i>t t O</i> | [Modbus time out] 0.1 to 30 s | 0.1 to 30 s | 10.0 s |
| <i>C O n I</i> <i>r O t O</i> <i>r O t 1</i> <i>r 1 t O</i> <i>r 1 t 1</i> | [Mdb com stat] <i>[r0t0] (r O t O)</i> : Modbus no reception, no transmission = communication idle <i>[r0t1] (r O t 1)</i> : Modbus no reception, transmission <i>[r1t0] (r 1 t O)</i> : Modbus reception, no transmission <i>[r1t1] (r 1 t 1)</i> : Modbus reception and transmission | | |

★ These parameters only appear if the corresponding function has been selected in another menu. When the parameters can also be accessed and adjusted from within the configuration menu for the corresponding function, their description is detailed in these menus, on the pages indicated, to aid programming.

Parameters described in this page can be accessed by:

DRI- > CONF > FULL > COM- > BTH-

BLUETOOTH

| Code | Name / Description | Adjustment range | Factory setting |
|--|---|-----------------------------|---------------------------|
| C 0 0 - | [COMMUNICATION] (continued) | | |
| b t H - | [BLUETOOTH] | | |
| P A n | [Device Name] Device name set with graphic display terminal. Note: The length is up to 16 alphanumeric digits on the product. According to bluetooth driver, device name must not exceed 14 digits. Digits n°14 & 15 will not be displayed through bluetooth network. | | |
| n A C | [Mac @] Read only information accessible with graphic display terminal (XX-XX-XX-XX-XX-XX). This information is also available on the label in front of the product. | | |
| b t U A | [Bluetooth Activation] Activation of the integrated Bluetooth. | | [OFF] (0 F F) |
| 0 F F 0 n | [OFF] (0 F F): Integrated Bluetooth deactivated [ON] (0 n): Integrated Bluetooth activated | | |
| b t U C ★ | [Bluetooth Visibility] Bluetooth Visibility Condition. | | [No] (n 0) |
| n 0 F L t Y E S L I 1 . . . | [No] (n 0): Not assigned [No drive flt] (F l t): Drive in fault state [Yes] (Y E S): Yes [LI1] (L I 1): Logical input LI1 [...] (. . .): See the assignment conditions on page 138 | | |
| b t P I | [PIN code] Bluetooth PIN code from 0 to 9,999. Example: In order to set a pin code like "0001", just set "1". | 0 to 9,999 | 0 |
| C 0 0 - | [COMMUNICATION] (continued) | | |
| C n 0 - | [CANopen] | | |
| A d C 0 0 F F - | [CANopen address] [OFF] (0 F F): OFF 1 to 127 | [OFF] (0 F F) to 127 | [OFF] (0 F F) |
| b d C 0 5 0 1 2 5 2 5 0 5 0 0 1 n | [CANopen bit rate] [50 kbps] (5 0): 50,000 Bauds [125 kbps] (1 2 5): 125,000 Bauds [250 kbps] (2 5 0): 250,000 Bauds [500 kbps] (5 0 0): 500,000 Bauds [1 Mbps] (1 n): 1 MBauds | | [250 kbps] (2 5 0) |
| E r C 0 | [Error code] Read-only parameter, cannot be modified. | 0 to 5 | - |

| Code | Name / Description | Adjustment range | Factory setting |
|---------------|---|------------------|------------------|
| COMM - | [COMMUNICATION] (continued) | | |
| cbd - | [COMMUNICATION CARD] See the specific documentation for the card used. | | |
| LCF - | [FORCED LOCAL] | | |
| FLO | [Forced local assign.] | | [No] (nD) |
| | <div style="border: 1px solid black; padding: 10px; margin: 10px auto; width: 80%;"> <p style="text-align: center;">⚠ WARNING</p> <p>LOSS OF CONTROL If the equipment switches to forced local mode, virtual input used in the current configuration will remain fixed at the last value transmitted. Do not use the virtual input and forced local mode in the same configuration. Failure to follow these instructions can result in death, serious injury, or equipment damage.</p> </div> | | |
| | <p>Forced local assignment. Forced local mode is active when the input is at state 1. [Forced local assign.] (FLO) is forced to [No] (nD) if [Profile] (CHF) is set to [I/O profile] (ID) page 139.</p> <p>nD [No] (nD): Function inactive L I 1 [LI1] (L I 1): Logical input LI1 ... L I 6 [LI6] (L I 6): Logical input LI6 L A 1 1 [LAI1] (L A 1 1): Logical input AI1 L A 1 2 [LAI2] (L A 1 2): Logical input AI2 O L 0 1 [OL01] (O L 0 1): Function blocks: Logical Output 01 ... O L 1 0 [OL10] (O L 1 0): Function blocks: Logical Output 10</p> | | |
| FLOC | [Forced local Ref.] | | [No] (nD) |
| | <p>Forced local reference source assignment.</p> <p>nD [No] (nD): Not assigned (control via the terminals with zero reference) A 1 1 [AI1] (A 1 1): Analog input A 1 2 [AI2] (A 1 2): Analog input A 1 3 [AI3] (A 1 3): Analog input L C C [HMI] (L C C): Assignment of the reference and command to the graphic display terminal or remote display terminal. Reference: [HMI Frequency ref.] (LFr) page 44. Command: RUN/STOP/FWD/REV keys. P I [RP] (P I): Pulse input O A 0 1 [OA01] (O A 0 1): Function blocks: Analog Output 01 ... O A 1 0 [OA10] (O A 1 0): Function blocks: Analog Output 10</p> | | |
| FLOt | [Time-out forc. local] | 0.1 to 30 s | 10.0 s |
| ★ | <p>0.1 to 30 s. This parameter can be accessed if [Forced local assign.] (FLO) is not set to [No] (nD). Time delay before communication monitoring is resumed on leaving forced local mode.</p> | | |



These parameters only appear if the corresponding function has been selected in another menu. When the parameters can also be accessed and adjusted from within the configuration menu for the corresponding function, their description is detailed in these menus, on the pages indicated, to aid programming.

Access Level

See [\[Access Level\]](#) (LFC) page [262](#).

Interface (ItF)

6

What's in this Chapter?

This chapter contains the following topics:

| Topic | Page |
|--------------------------------|---------------------|
| Access Level (LAC) | 262 |
| Language (LnG) | 264 |
| Monitoring Configuration (MCF) | 265 |
| Display configuration (dCF) | 269 |

Parameters described in this page can be accessed by:

ITF-

Access Level (LAC)

With integrated display terminal:

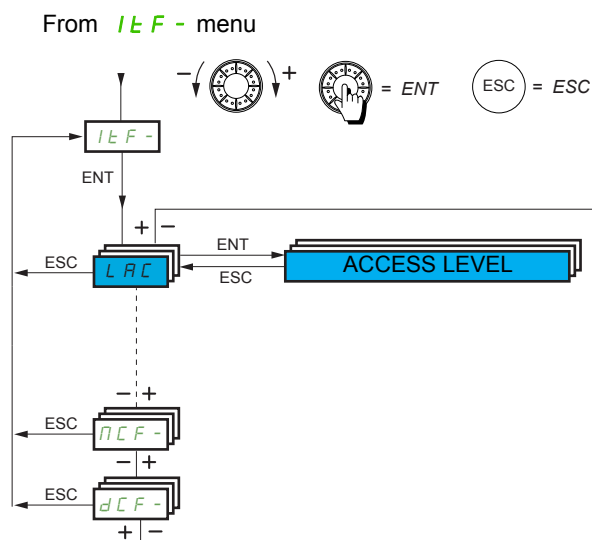

| Code | Name / Description | Factory setting |
|--------------|---|-------------------------|
| <i>ITF -</i> | [3 INTERFACE] | |
| <i>LAC</i> | [3.1 ACCESS LEVEL] | [Standard] (SEd) |
| () | <p><i>bAs</i> [Basic] (bAs): Limited access to [SIMPLY START] (SIn -), [1.2 MONITORING] (nDn -), [SETTINGS] (SEt -), [FACTORY SETTINGS] (FCs -), [5 PASSWORD] (CDd) and [3.1 ACCESS LEVEL] (LAc -) menus. Only one function can be assigned to each input.</p> <p><i>SEd</i> [Standard] (SEd): Access to all menus on the integrated display terminal. Only one function can be assigned to each input.</p> <p><i>AdU</i> [Advanced] (AdU): Access to all menus on the integrated display terminal. Several functions can be assigned to each input.</p> <p><i>EPr</i> [Expert] (EPr): Access to all menus on the integrated display terminal and access to additional parameters. Several functions can be assigned to each input.</p> | |



Parameter that can be modified during operation or when stopped.

Comparison of the menus that can be accessed on the graphic display terminal/integrated display terminal

| | | Access level | | | |
|--|---|---------------------|---------------------|---|--|
| [1 DRIVE MENU] (dr I-) | | Basic BA5 | Standard SEd | | |
| | [1.1 SPEED REFERENCE] (r EF-) | | | | |
| | [1.2 MONITORING] (n Dn -) | | | | |
| | n n n - (Monitoring motor) | | | | |
| | I O n - (I/O MAP) | | | | |
| | S A F - (Monitoring Safety) | | | | |
| | n F b - (Monitoring Function Blocks) | | | | |
| | C n n - (Communication Map) | | | | |
| | n P I - (Monitoring PI) | | | | |
| | P E t - (Monitoring Power time) | | | | |
| | A L r - (Alarms) (1) | | | | |
| | S S t - (Other state) (1) | | | | |
| | C O d - (Password) | | | | |
| | [1.3 CONFIGURATION] (C DnF) | | | | |
| | n y n n - (My Menu) | | | | |
| | F C S - (Factory Settings) | | | | |
| | F U L L (Full) | | | | |
| | S I n - (Simply Start) | | | | |
| | S E t - (Settings) | | | | |
| | F b n - (Function Blocks) | | | | |
| [2 IDENTIFICATION] (D Id -) (1) | | Advanced ADU | Expert EP r | | |
| [3 INTERFACE] (I t F -) (1) | | | | | |
| | [3.1 ACCESS LEVEL] (L A C) | | | | |
| | [3.2 LANGUAGE] (L n G) | | | | |
| [4 OPEN / SAVE AS] (t r R -) (1) | | | | | |
| [5 PASSWORD] (C O d -) (1) | | | | | |
| A single function can be assigned to each input. | | | | | |
| [1 DRIVE MENU] (dr I-) | [1.2 MONITORING] (n Dn -) | | | d G t - (Diagnostics) | |
| | [1.3 CONFIGURATION] (C DnF) | | | F U L L (Full) | |
| | | | | d r C - (Motor Control) | |
| | | | | I _ O - (Inputs / Outputs Configuration) | |
| | | | | C t L - (Command) | |
| | | | | F U n - (Application function) | |
| | | | | F L t - (Fault Management) | |
| | | | | C O n - (Communication) | |
| [3 INTERFACE] (I t F -) (1) | [3.3 MONITORING CONFIG.] (n C F -) | | | | |
| A single function can be assigned to each input. | | | | | |
| | [3.4 DISPLAY CONFIG.] (d C F -) (1) | | | | |
| Several functions can be assigned to each input. | | | | | |
| Expert parameters | | | | | |
| Several functions can be assigned to each input. | | | | | |

(1) Can be accessed only with graphic display terminal.

Parameters described in this page can be accessed by:

ITF-

Language (LnG)

| | | | |
|--------------|------|---------|-------|
| RDY | Term | +0.0 Hz | 0.0 A |
| 3.2 LANGUAGE | | | |
| English | | | |
| Français ✓ | | | |
| Deutsch | | | |
| Español | | | |
| Italiano | | | |
| << | | >> | |
| | | Quick | |
| Chinese | | | |
| Русский | | | |
| Türkçe | | | |

When only one selection is possible, the selection made is indicated by ✓

Example: Only one language can be chosen.

| Code | Name / Description | Factory setting |
|--------------|-----------------------------|-----------------------------|
| LnG | [3.2 LANGUAGE] | [Language 0] (LnG 0) |
| () | Current language index. | |
| LnG 0 | [Language 0] (LnG 0) | |
| ... | ... | |
| LnG 9 | [Language 9] (LnG 9) | |

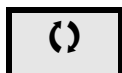

Parameter that can be modified during operation or when stopped.

Monitoring Configuration (MCF)

This menu can only be accessed with the graphic display terminal.

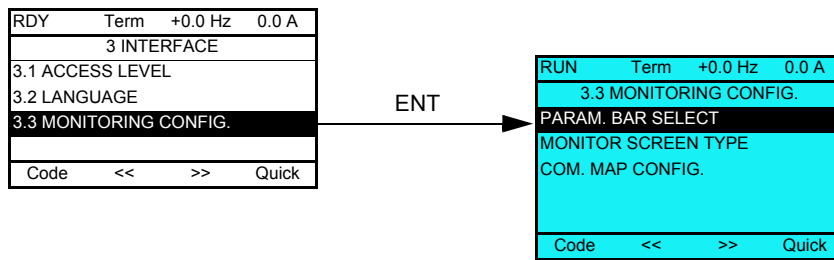

This can be used to configure the information displayed on the graphic display screen during operation.



[PARAM. BAR SELECT]: Selection of 1 to 2 parameters displayed on the top line (the first 2 cannot be modified).

[MONITOR SCREEN TYPE]: Selection of parameters displayed in the centre of the screen and the display mode (digital values or bar graph format).

[COM. MAP CONFIG.]: Selection of the words displayed and their format.

Parameters described in this page can be accessed by:

ITF- > MCF-

| Code | Name / Description |
|--------------|--------------------------------|
| ΠCF - | [3.3 MONITORING CONFIG] |

| Code | Name / Description | | | | | | | | | | | | | | | | | | | | | | | | | | | | | | | | | | | | | | | | | | | | | | | | | | | | | | | | | | | | | | | | | | |
|-----------------------|---|-------|------|-------|------|-------|-------|-------|------|-------------------|--|----------------|--|------------------|---|--------------------|-------|-----------------|--|---------------|--------|-----------------|------|---------------|------|----------------|--------|-----------------|------|-----------------------|--------|----------------------|--------|---------------|--|------------|--|-----------------|--|----------------------|--|------------------|------------|-----------------|--------|----------------|--------|-------------|--------|--------------|-------|------------------|--|-----------------------|--|-------------------|--|------------|--|-------|-------------------------------------|-------|--------------------------|-------|--------------------------|-------|-------------------------------------|
| Pb5 - | [PARAM. BAR SELECT] | | | | | | | | | | | | | | | | | | | | | | | | | | | | | | | | | | | | | | | | | | | | | | | | | | | | | | | | | | | | | | | | | | |
| | <table> <tbody> <tr> <td>[AI1]</td> <td>in V</td> </tr> <tr> <td>[AI2]</td> <td>in V</td> </tr> <tr> <td>[AI3]</td> <td>in mA</td> </tr> <tr> <td>[AO1]</td> <td>in V</td> </tr> <tr> <td>[ETA state world]</td> <td></td> </tr> <tr> <td>[Alarm groups]</td> <td></td> </tr> <tr> <td>[Frequency ref.]</td> <td>in Hz: parameter displayed in factory configuration</td> </tr> <tr> <td>[Output frequency]</td> <td>in Hz</td> </tr> <tr> <td>[Motor current]</td> <td>in A: parameter displayed in factory configuration</td> </tr> <tr> <td>[Motor speed]</td> <td>in rpm</td> </tr> <tr> <td>[Motor voltage]</td> <td>in V</td> </tr> <tr> <td>[Motor power]</td> <td>in W</td> </tr> <tr> <td>[Motor torque]</td> <td>as a %</td> </tr> <tr> <td>[Mains voltage]</td> <td>in V</td> </tr> <tr> <td>[Motor thermal state]</td> <td>as a %</td> </tr> <tr> <td>[Drv. thermal state]</td> <td>as a %</td> </tr> <tr> <td>[Consumption]</td> <td>in Wh or kWh depending on drive rating</td> </tr> <tr> <td>[Run time]</td> <td>in hours (length of time the motor has been switched on)</td> </tr> <tr> <td>[Power on time]</td> <td>in hours (length of time the drive has been switched on)</td> </tr> <tr> <td>[IGBT alarm counter]</td> <td>in seconds (total time of IGBT overheating alarms)</td> </tr> <tr> <td>[Min. freq time]</td> <td>in seconds</td> </tr> <tr> <td>[PID reference]</td> <td>as a %</td> </tr> <tr> <td>[PID feedback]</td> <td>as a %</td> </tr> <tr> <td>[PID error]</td> <td>as a %</td> </tr> <tr> <td>[PID Output]</td> <td>in Hz</td> </tr> <tr> <td>[Config. active]</td> <td>CNF0, 1 or 2 (see page 217)</td> </tr> <tr> <td>[Utilised param. set]</td> <td>SET1, 2 or 3 (see page 215)</td> </tr> </tbody> </table> <p>Select the parameter using ENT (a <input checked="" type="checkbox"/> then appears next to the parameter). Parameter(s) can also be deselected using ENT. 1 or 2 parameters can be selected.</p> <p>Example:</p> <table border="1"> <thead> <tr> <th colspan="2">PARAM. BAR SELECT</th> </tr> <tr> <th colspan="2">MONITORING</th> </tr> </thead> <tbody> <tr> <td>-----</td> <td><input checked="" type="checkbox"/></td> </tr> <tr> <td>-----</td> <td><input type="checkbox"/></td> </tr> <tr> <td>-----</td> <td><input type="checkbox"/></td> </tr> <tr> <td>-----</td> <td><input checked="" type="checkbox"/></td> </tr> </tbody> </table> | [AI1] | in V | [AI2] | in V | [AI3] | in mA | [AO1] | in V | [ETA state world] | | [Alarm groups] | | [Frequency ref.] | in Hz: parameter displayed in factory configuration | [Output frequency] | in Hz | [Motor current] | in A: parameter displayed in factory configuration | [Motor speed] | in rpm | [Motor voltage] | in V | [Motor power] | in W | [Motor torque] | as a % | [Mains voltage] | in V | [Motor thermal state] | as a % | [Drv. thermal state] | as a % | [Consumption] | in Wh or kWh depending on drive rating | [Run time] | in hours (length of time the motor has been switched on) | [Power on time] | in hours (length of time the drive has been switched on) | [IGBT alarm counter] | in seconds (total time of IGBT overheating alarms) | [Min. freq time] | in seconds | [PID reference] | as a % | [PID feedback] | as a % | [PID error] | as a % | [PID Output] | in Hz | [Config. active] | CNF0, 1 or 2 (see page 217) | [Utilised param. set] | SET1, 2 or 3 (see page 215) | PARAM. BAR SELECT | | MONITORING | | ----- | <input checked="" type="checkbox"/> | ----- | <input type="checkbox"/> | ----- | <input type="checkbox"/> | ----- | <input checked="" type="checkbox"/> |
| [AI1] | in V | | | | | | | | | | | | | | | | | | | | | | | | | | | | | | | | | | | | | | | | | | | | | | | | | | | | | | | | | | | | | | | | | | |
| [AI2] | in V | | | | | | | | | | | | | | | | | | | | | | | | | | | | | | | | | | | | | | | | | | | | | | | | | | | | | | | | | | | | | | | | | | |
| [AI3] | in mA | | | | | | | | | | | | | | | | | | | | | | | | | | | | | | | | | | | | | | | | | | | | | | | | | | | | | | | | | | | | | | | | | | |
| [AO1] | in V | | | | | | | | | | | | | | | | | | | | | | | | | | | | | | | | | | | | | | | | | | | | | | | | | | | | | | | | | | | | | | | | | | |
| [ETA state world] | | | | | | | | | | | | | | | | | | | | | | | | | | | | | | | | | | | | | | | | | | | | | | | | | | | | | | | | | | | | | | | | | | | |
| [Alarm groups] | | | | | | | | | | | | | | | | | | | | | | | | | | | | | | | | | | | | | | | | | | | | | | | | | | | | | | | | | | | | | | | | | | | |
| [Frequency ref.] | in Hz: parameter displayed in factory configuration | | | | | | | | | | | | | | | | | | | | | | | | | | | | | | | | | | | | | | | | | | | | | | | | | | | | | | | | | | | | | | | | | | |
| [Output frequency] | in Hz | | | | | | | | | | | | | | | | | | | | | | | | | | | | | | | | | | | | | | | | | | | | | | | | | | | | | | | | | | | | | | | | | | |
| [Motor current] | in A: parameter displayed in factory configuration | | | | | | | | | | | | | | | | | | | | | | | | | | | | | | | | | | | | | | | | | | | | | | | | | | | | | | | | | | | | | | | | | | |
| [Motor speed] | in rpm | | | | | | | | | | | | | | | | | | | | | | | | | | | | | | | | | | | | | | | | | | | | | | | | | | | | | | | | | | | | | | | | | | |
| [Motor voltage] | in V | | | | | | | | | | | | | | | | | | | | | | | | | | | | | | | | | | | | | | | | | | | | | | | | | | | | | | | | | | | | | | | | | | |
| [Motor power] | in W | | | | | | | | | | | | | | | | | | | | | | | | | | | | | | | | | | | | | | | | | | | | | | | | | | | | | | | | | | | | | | | | | | |
| [Motor torque] | as a % | | | | | | | | | | | | | | | | | | | | | | | | | | | | | | | | | | | | | | | | | | | | | | | | | | | | | | | | | | | | | | | | | | |
| [Mains voltage] | in V | | | | | | | | | | | | | | | | | | | | | | | | | | | | | | | | | | | | | | | | | | | | | | | | | | | | | | | | | | | | | | | | | | |
| [Motor thermal state] | as a % | | | | | | | | | | | | | | | | | | | | | | | | | | | | | | | | | | | | | | | | | | | | | | | | | | | | | | | | | | | | | | | | | | |
| [Drv. thermal state] | as a % | | | | | | | | | | | | | | | | | | | | | | | | | | | | | | | | | | | | | | | | | | | | | | | | | | | | | | | | | | | | | | | | | | |
| [Consumption] | in Wh or kWh depending on drive rating | | | | | | | | | | | | | | | | | | | | | | | | | | | | | | | | | | | | | | | | | | | | | | | | | | | | | | | | | | | | | | | | | | |
| [Run time] | in hours (length of time the motor has been switched on) | | | | | | | | | | | | | | | | | | | | | | | | | | | | | | | | | | | | | | | | | | | | | | | | | | | | | | | | | | | | | | | | | | |
| [Power on time] | in hours (length of time the drive has been switched on) | | | | | | | | | | | | | | | | | | | | | | | | | | | | | | | | | | | | | | | | | | | | | | | | | | | | | | | | | | | | | | | | | | |
| [IGBT alarm counter] | in seconds (total time of IGBT overheating alarms) | | | | | | | | | | | | | | | | | | | | | | | | | | | | | | | | | | | | | | | | | | | | | | | | | | | | | | | | | | | | | | | | | | |
| [Min. freq time] | in seconds | | | | | | | | | | | | | | | | | | | | | | | | | | | | | | | | | | | | | | | | | | | | | | | | | | | | | | | | | | | | | | | | | | |
| [PID reference] | as a % | | | | | | | | | | | | | | | | | | | | | | | | | | | | | | | | | | | | | | | | | | | | | | | | | | | | | | | | | | | | | | | | | | |
| [PID feedback] | as a % | | | | | | | | | | | | | | | | | | | | | | | | | | | | | | | | | | | | | | | | | | | | | | | | | | | | | | | | | | | | | | | | | | |
| [PID error] | as a % | | | | | | | | | | | | | | | | | | | | | | | | | | | | | | | | | | | | | | | | | | | | | | | | | | | | | | | | | | | | | | | | | | |
| [PID Output] | in Hz | | | | | | | | | | | | | | | | | | | | | | | | | | | | | | | | | | | | | | | | | | | | | | | | | | | | | | | | | | | | | | | | | | |
| [Config. active] | CNF0, 1 or 2 (see page 217) | | | | | | | | | | | | | | | | | | | | | | | | | | | | | | | | | | | | | | | | | | | | | | | | | | | | | | | | | | | | | | | | | | |
| [Utilised param. set] | SET1, 2 or 3 (see page 215) | | | | | | | | | | | | | | | | | | | | | | | | | | | | | | | | | | | | | | | | | | | | | | | | | | | | | | | | | | | | | | | | | | |
| PARAM. BAR SELECT | | | | | | | | | | | | | | | | | | | | | | | | | | | | | | | | | | | | | | | | | | | | | | | | | | | | | | | | | | | | | | | | | | | |
| MONITORING | | | | | | | | | | | | | | | | | | | | | | | | | | | | | | | | | | | | | | | | | | | | | | | | | | | | | | | | | | | | | | | | | | | |
| ----- | <input checked="" type="checkbox"/> | | | | | | | | | | | | | | | | | | | | | | | | | | | | | | | | | | | | | | | | | | | | | | | | | | | | | | | | | | | | | | | | | | |
| ----- | <input type="checkbox"/> | | | | | | | | | | | | | | | | | | | | | | | | | | | | | | | | | | | | | | | | | | | | | | | | | | | | | | | | | | | | | | | | | | |
| ----- | <input type="checkbox"/> | | | | | | | | | | | | | | | | | | | | | | | | | | | | | | | | | | | | | | | | | | | | | | | | | | | | | | | | | | | | | | | | | | |
| ----- | <input checked="" type="checkbox"/> | | | | | | | | | | | | | | | | | | | | | | | | | | | | | | | | | | | | | | | | | | | | | | | | | | | | | | | | | | | | | | | | | | |

Monitor screen type

| Code | Name / Description | Factory setting |
|----------------|---|--------------------------|
| Π 5 C - | [MONITOR SCREEN TYPE] | |
| Π d E | [Display value type] | [Digital] (d E C) |
| () | [Digital] (d E C) [Bar graph] (b A r) [List] (L I S E) | |

Π P C [PARAMETER SELECTION]

| | |
|-------------------------|--|
| [AI1] | in V |
| [AI2] | in V |
| [AI3] | in mA |
| [AO1] | in V |
| [ETA state world] | |
| [Alarm groups] | |
| [Frequency ref.] | in Hz: parameter displayed in factory configuration |
| [Output frequency] | in Hz |
| [Pulse in. work. freq.] | in A: parameter displayed in factory configuration |
| [Motor current] | in Hz |
| [Motor speed] | in rpm |
| [Motor voltage] | in V |
| [Motor power] | in W |
| [Motor torque] | as a % |
| [Mains voltage] | in V |
| [Motor thermal state] | as a % |
| [Drv. thermal state] | as a % |
| [Consumption] | in Wh or kWh depending on drive rating |
| [Run time] | in hours (length of time the motor has been switched on) |
| [Power on time] | in hours (length of time the drive has been switched on) |
| [IGBT alarm counter] | in seconds (total time of IGBT overheating alarms) |
| [Min. freq time] | in seconds |
| [PID reference] | as a % |
| [PID feedback] | as a % |
| [PID error] | as a % |
| [PID Output] | in Hz |



Select the parameter(s) using ENT (a ✓ then appears next to the parameter). Parameter(s) can also be deselected using ENT.

| PARAMETER SELECTION | |
|---------------------|---|
| MONITORING | |
| ----- | ✓ |
| ----- | |
| ----- | ✓ |
| ----- | |

Examples include:

Display of 2 digital values

| RUN | Term | +35.0 Hz | 80.0 A |
|---------------|------|----------|--------|
| Motor speed | | | |
| 1250 rpm | | | |
| Motor current | | | |
| 80 A | | | |
| Quick | | | |

Display of 2 bar graphs

| RUN | Term | +35.0 Hz | 80.0 A |
|-------------|---------------|----------|--------|
| Min | Motor speed | max | |
| 0 | 1250 rpm | 1500 | |
| [Bar graph] | | | |
| Min | Motor current | max | |
| 0 | 80 A | 150 | |
| [Bar graph] | | | |
| Quick | | | |

Display of a list of 5 values

| RUN | Term | +35.0 Hz | 80.0 A |
|----------------------|----------|----------|--------|
| 1.2 MONITORING | | | |
| Frequency ref. | : | 50.1Hz | |
| Motor current: | 80 A | | |
| Motor speed: | 1250 rpm | | |
| Motor thermal state: | 80% | | |
| Drv thermal state | : | 80% | |
| Quick | | | |









 These parameters only appear if the corresponding function has been selected in another menu. When the parameters can also be accessed and adjusted from within the configuration menu for the corresponding function, their description is detailed in these menus, on the pages indicated, to aid programming.

 Parameter that can be modified during operation or when stopped.

Parameters described in this page can be accessed by:

ITF- > MCF- > ADL-

Communication map configuration

| Code | Name / Description | Factory setting | | | | | | | | | | | | | | | | | | | | | | | | |
|--|--|-----------------|--------|----------|--------|-------------------|--|--|--|-------|--|--|--|-------|--|--|--|--------|------|-----|--|-------------|--|--|--|-------------|
| ADL - | [COM. MAP CONFIG.] | | | | | | | | | | | | | | | | | | | | | | | | | |
| IRd1  | [Word 1 add. select.] Select the address of the word to be displayed by pressing the << and >> (F2 and F3) keys and rotating the jog dial. | 0 | | | | | | | | | | | | | | | | | | | | | | | | |
| FRd1  | [Format word 1] Format of word 1. HE [Hex] (HE) 5 IG [Signed] (5 IG) n 5 G [Unsigned] (n 5 G) | [Hex] (HE) | | | | | | | | | | | | | | | | | | | | | | | | |
| IRd2  | [Word 2 add. select.] Select the address of the word to be displayed by pressing the << and >> (F2 and F3) keys and rotating the jog dial. | 0 | | | | | | | | | | | | | | | | | | | | | | | | |
| FRd2  | [Format word 2] Format of word 2. HE [Hex] (HE) 5 IG [Signed] (5 IG) n 5 G [Unsigned] (n 5 G) | [Hex] (HE) | | | | | | | | | | | | | | | | | | | | | | | | |
| IRd3  | [Word 3 add. select.] Select the address of the word to be displayed by pressing the << and >> (F2 and F3) keys and rotating the jog dial. | 0 | | | | | | | | | | | | | | | | | | | | | | | | |
| FRd3  | [Format word 3] Format of word 3. HE [Hex] (HE) 5 IG [Signed] (5 IG) n 5 G [Unsigned] (n 5 G) | [Hex] (HE) | | | | | | | | | | | | | | | | | | | | | | | | |
| IRd4  | [Word 4 add. select.] Select the address of the word to be displayed by pressing the << and >> (F2 and F3) keys and rotating the jog dial. | 0 | | | | | | | | | | | | | | | | | | | | | | | | |
| FRd4  | [Format word 4] Format of word 4. HE [Hex] (HE) 5 IG [Signed] (5 IG) n 5 G [Unsigned] (n 5 G) Then, it will be possible to view the selected words in the [COMMUNICATION MAP] submenu of the [1.2 MONITORING] menu. Example: <table border="1" data-bbox="247 1668 558 1870"> <tr> <td>RUN</td> <td>Term</td> <td>+35.0 Hz</td> <td>80.0 A</td> </tr> <tr> <td colspan="4" style="text-align: center;">COMMUNICATION MAP</td> </tr> <tr> <td colspan="4" style="text-align: center;">-----</td> </tr> <tr> <td colspan="4" style="text-align: center;">-----</td> </tr> <tr> <td>W3141:</td> <td>F230</td> <td>Hex</td> <td></td> </tr> <tr> <td colspan="4" style="text-align: center;"><< >> Quick</td> </tr> </table> | RUN | Term | +35.0 Hz | 80.0 A | COMMUNICATION MAP | | | | ----- | | | | ----- | | | | W3141: | F230 | Hex | | << >> Quick | | | | [Hex] (HE) |
| RUN | Term | +35.0 Hz | 80.0 A | | | | | | | | | | | | | | | | | | | | | | | |
| COMMUNICATION MAP | | | | | | | | | | | | | | | | | | | | | | | | | | |
| ----- | | | | | | | | | | | | | | | | | | | | | | | | | | |
| ----- | | | | | | | | | | | | | | | | | | | | | | | | | | |
| W3141: | F230 | Hex | | | | | | | | | | | | | | | | | | | | | | | | |
| << >> Quick | | | | | | | | | | | | | | | | | | | | | | | | | | |



Parameter that can be modified during operation or when stopped.

Display configuration (dCF)

This menu can only be accessed with the graphic display terminal. It can be used to customize parameters of a menu and to access parameters.

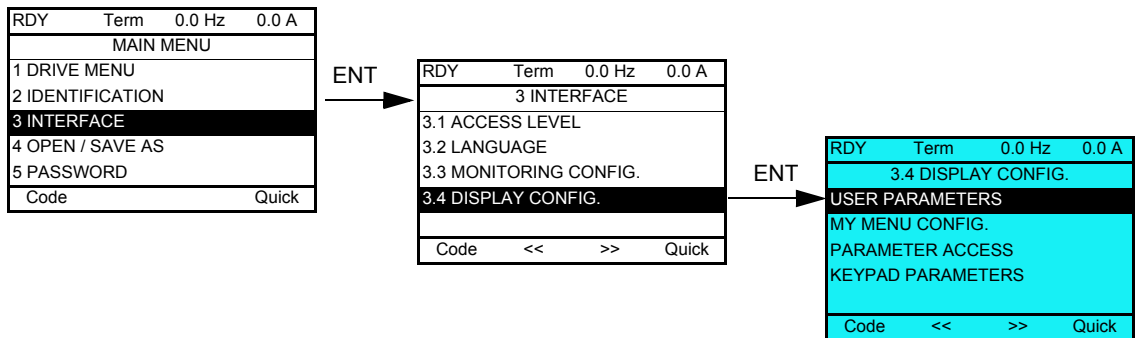



- USER PARAMETERS: Customization of 1 to 15 parameters.
- MY MENU: Creation of a customized menu.
- PARAMETER ACCESS: Customization of the visibility and protection mechanisms of menus and parameters.
- KEYPAD PARAMETERS: Adjustment of the contrast and stand-by mode of the graphic display terminal (parameters stored in the terminal rather than in the drive). Choice of the menu displayed on power up.

| Code | Name / Description |
|-------|----------------------|
| dCF - | [3.4 DISPLAY CONFIG] |

User parameters

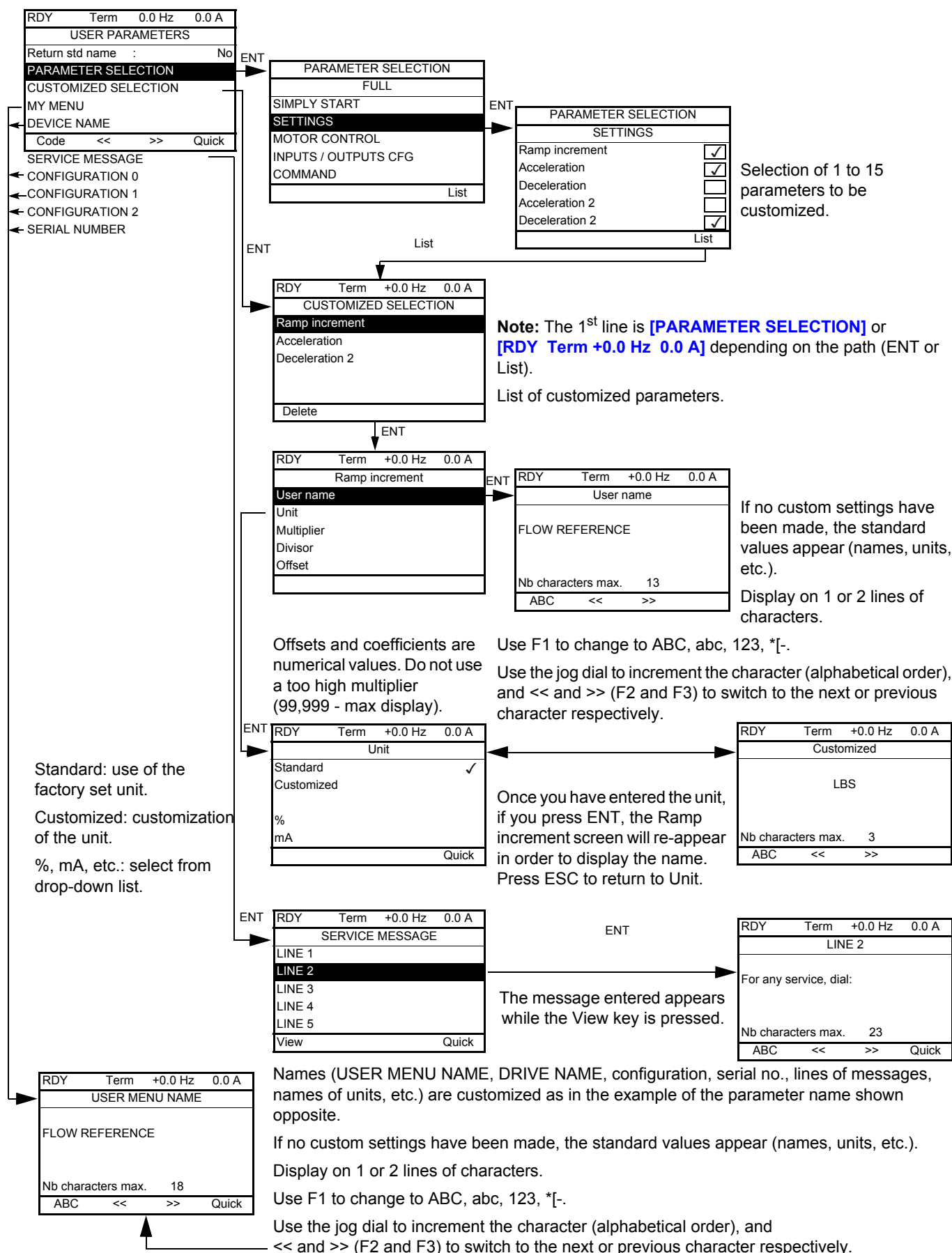
If **[Return std name]** is set to **[Yes]**, the display reverts to standard but the custom settings remain stored.



| Code | Name / Description | Factory setting |
|---|---|------------------|
| CUP - | [USER PARAMETERS] | |
| GSP  | [Return std name] Display standard parameters instead of customised ones. | [No] (n0) |
| n0 YES | [No] (n0) [Yes] (YES) | |
| MYNN | [MY MENU] | |
| PAn | [DEVICE NAME] | |
| SEr - | [SERVICE MESSAGE] | |
| SNL01 | [LINE 1] | |
| SNL02 | [LINE 2] | |
| SNL03 | [LINE 3] | |
| SNL04 | [LINE 4] | |
| SNL05 | [LINE 5] | |
| CFN01 | [CONFIGURATION 0] | |
| CFN02 | [CONFIGURATION 1] | |
| CFN03 | [CONFIGURATION 2] | |
| PSn | [SERIAL NUMBER] | |



Parameter that can be modified during operation or when stopped.

My Menu config.

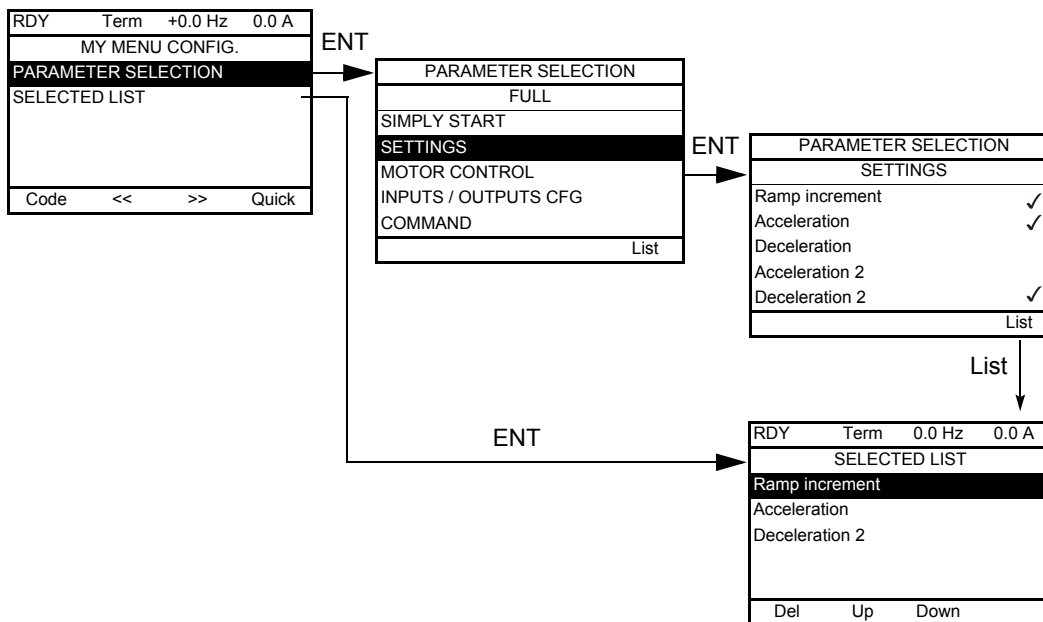

Selection of parameters included in the user menu.

Note: The 1st line is [PARAMETER SELECTION] or [RDY Term +0.0 Hz 0.0 A] depending on the path (ENT or List).

Parameter list making up the user menu.

Use the F2 and F3 keys to arrange the parameters in the list (example below using F3).

| | | | |
|------------------|------|---------|-------|
| RDY | Term | +0.0 Hz | 0.0 A |
| SELECTED LIST | | | |
| Acceleration | | | |
| Ramp increment | | | |
| Speed prop. gain | | | |
| Del | Up | Down | |

| Code | Name / Description |
|-------|--------------------|
| MYC - | [MY MENU CONFIG.] |

Parameters described in this page can be accessed by:

ITF- > DCF- > PAC- > PRO- > PCD-

| Code | Name / Description | Factory setting |
|--|--|--------------------------------|
| <i>PAC -</i> | [PARAMETER ACCESS] | |
| <i>PRO -</i> | [PROTECTION] | |
| <i>PCD -</i> | [PROTECTED CHANNELS] | |
| <i>CDn</i> <i>PS</i> <i>Modb</i> <i>CAN</i> <i>net</i> | [HMI] (<i>CDn</i>): Graphic display terminal or remote display terminal [PC Tool] (<i>PS</i>): PC Software [Modbus] (<i>Modb</i>): Integrated Modbus [CANopen] (<i>CAN</i>): Integrated CANopen® [Com. card] (<i>net</i>): Communication card (if inserted) | |
| <i>UIS -</i> | [VISIBILITY] | |
| <i>PUIS</i>  | [PARAMETERS] Parameter visibility: only active ones, or all parameters. | [Active] (<i>ACT</i>) |
| <i>ACT</i> <i>ALL</i> | [Active] (<i>ACT</i>) [All] (<i>ALL</i>) | |



Parameter that can be modified during operation or when stopped.

Keypad parameters

| | | | |
|-------------------|------|--------|-------|
| RDY | Term | 0.0 Hz | 0.0 A |
| KEYPAD PARAMETERS | | | |
| Keypad contrast | : | | 50% |
| Keypad stand-by | : | | 5 min |
| Code | << | >> | Quick |

| Code | Name / Description | Adjustment range | Factory setting |
|---|---|----------------------------|-----------------|
| [CNL-] | [KEYPAD PARAMETERS] | | |
| [CrSt] () | [Keypad contrast] Contrast of the keypad. | 0 to 100% | 50% |
| [Sby] () [No] (nD): No | [Keypad stand-by] Graphic keypad standby delay. | [No] (nD) to 10 min | 5 min |



Parameter that can be modified during operation or when stopped.

Open / Save as (trA)

7

This menu can only be accessed with the graphic display terminal.

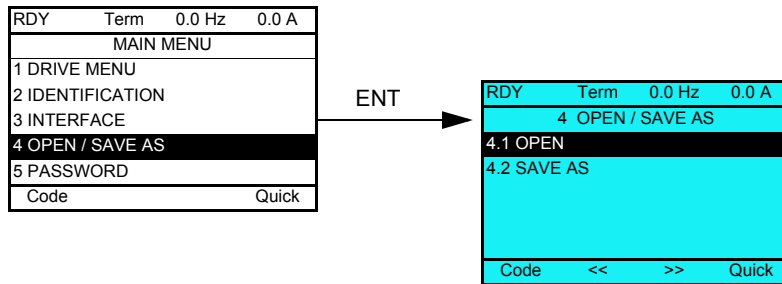

[4.1 OPEN]: To download one of the 4 files from the graphic display terminal to the drive.

[4.2 SAVE AS]: To download the current drive configuration to the graphic display terminal.

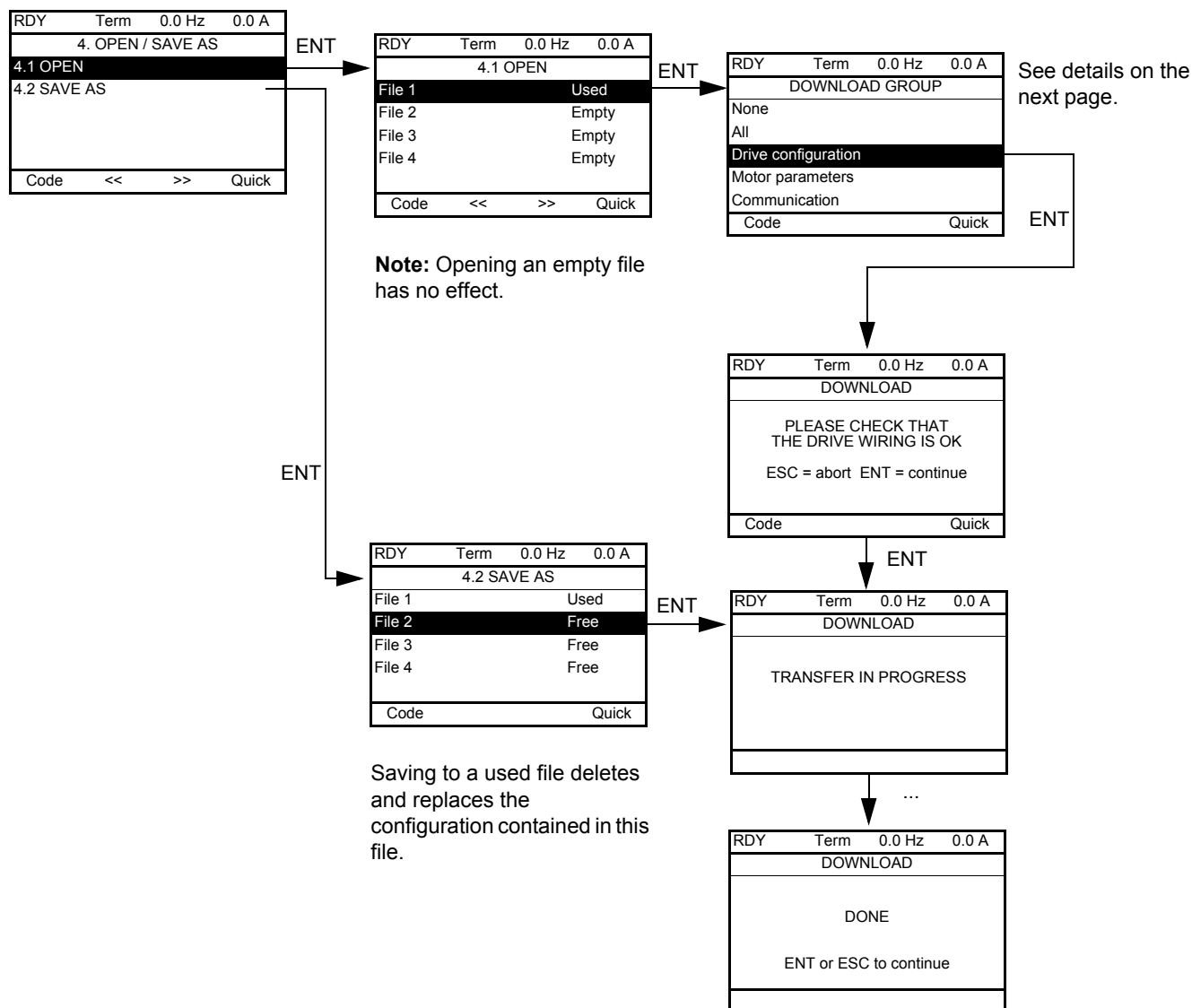

Various messages may appear when the download is requested:

- **[TRANSFER IN PROGRESS]**
- **[DONE]**
- Error messages if download not possible
- **[Motor parameters are NOT COMPATIBLE. Do you want to continue?]:** In this case, the download is possible, but the parameters will be restricted.

DOWNLOAD GROUP

| | | |
|------------------------|---|---|
| [None]: | | No parameters |
| [All]: | | All parameters in all menus |
| [Drive configuration]: | | The entire [1 DRIVE MENU] without [COMMUNICATION] |
| [Motor parameters]: | [Rated motor volt.] (U n 5) | In the [MOTOR CONTROL] (d r C -) menu |
| | [Rated motor freq.] (F r 5) | |
| | [PSI align curr. max] (Π C r) | |
| | [Rated motor speed] (n 5 P) | |
| | [Motor 1 Cosinus phi] (C D 5) | |
| | [Rated motor power] (n P r) | |
| | [Motor param choice] (Π P C) | |
| | [Tune selection] (5 E U n) | |
| | [Mot. therm. current] (I E H) | |
| | [IR compensation] (U F r) | |
| | [Slip compensation] (5 L P) | |
| | [Cust stator resist.] (r 5 R) | |
| | [Lfw] (L F R) | |
| | [Cust. rotor t const.] (E r R) | |
| | [Nominal I sync.] (n C r 5) | |
| | [Nom motor spdsync] (n 5 P 5) | |
| | [Pole pairs] (P P n 5) | |
| | [Syn. EMF constant] (P H 5) | |
| | [Autotune L d-axis] (L d 5) | |
| | [Autotune L q-axis] (L q 5) | |
| | [Nominal freq sync.] (F r 5 5) | |
| | [Cust. stator R syn] (r 5 R 5) | |
| | [Motor torque] (E q 5) | |
| | [U1] (U 1) | |
| | [F1] (F 1) | |
| | [U2] (U 2) | |
| | [F2] (F 2) | |
| | [U3] (U 3) | |
| | [F3] (F 3) | |
| | [U4] (U 4) | |
| | [F4] (F 4) | |
| | [U5] (U 5) | |
| | [F5] (F 5) | |
| | The motor parameters that can be accessed in [Expert] (E P r) mode, page 243. | |
| | [Mot. therm. current] (I E H) | In the [SETTINGS] (5 E E -) menu |
| [Communication] : | | All the parameters in the [COMMUNICATION] menu |

Password (COd)



With graphic display terminal

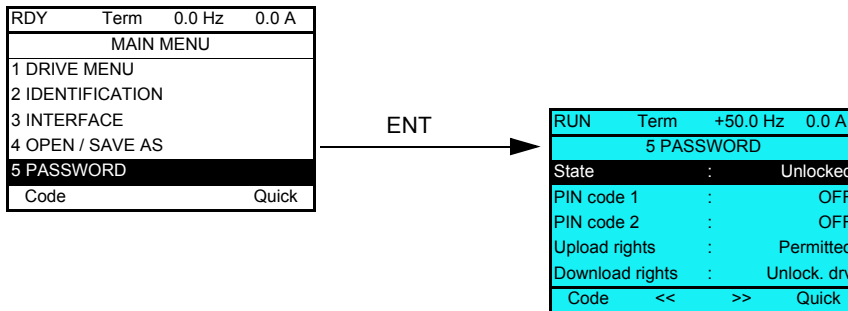

With integrated display terminal

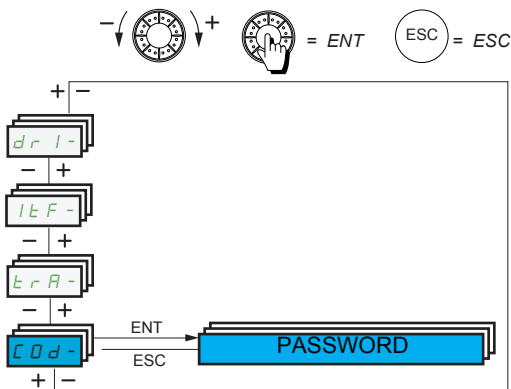

Enables the configuration to be protected with an access code or a password to be entered in order to access a protected configuration.

Example with graphic display terminal:

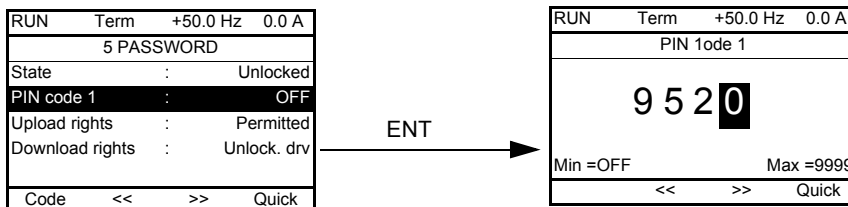

- The drive is unlocked when the PIN codes are set to **[Unlocked] (OFF)** (no password) or when the correct code has been entered. All menus are visible.
- Before protecting the configuration with an access code, you must:
 - Define the **[Upload rights] (ULr)** and **[Download rights] (dLr)**.
 - Make a careful note of the code and keep it in a place where you will be able to find it.

- The drive has 2 access codes, enabling 2 access levels to be set up:
 - PIN code 1 is a public unlock code: 6969.
 - PIN code 2 is an unlock code known only to Schneider Electric Product Support. It can only be accessed in **[Expert] (E P r)** mode.
 - Only one PIN1 or PIN2 code can be used, the other must remain set to **[OFF] (O F F)**.

Note: When the unlock code is entered, the user access code appears.

The following items are access-protected:

- Return to factory settings (**[FACTORY SETTINGS] (F C 5 -)** menu).
- The channels and parameters protected by the **[MY MENU] (M Y M N -)** as well as the menu itself.
- The custom display settings (**[3.4 DISPLAY CONFIG.] (d C F -)** menu).

| Code | Name / Description | Adjustment range | Factory setting |
|--|--|-------------------------------|--------------------------------|
| C O d - | [5 PASSWORD] | | |
| C 5 t | [State] Information parameter, cannot be modified. | | [Unlocked] (U L C) |
| L C U L C | [Locked] (L C) : The drive is locked by a password [Unlocked] (U L C) : The drive is not locked by a password | | |
| C O d | [PIN code 1] 1st access code. The value [OFF] (O F F) indicates that no password has been set [Unlocked] (U L C) . The value [ON] (O n) indicates that the drive is protected and an access code must be entered in order to unlock it. Once the correct code has been entered, it remains on the display and the drive is unlocked until the next time the power supply is disconnected. PIN code 1 is a public unlock code: 6969. | [OFF] (O F F) to 9,999 | [OFF] (O F F) |
| C O d 2 | [PIN code 2] This parameter can only be accessed in [Expert] (E P r) mode. 2nd access code. The value [OFF] (O F F) indicates that no password has been set [Unlocked] (U L C) . The value [ON] (O n) indicates that the drive is protected and an access code must be entered in order to unlock it. Once the correct code has been entered, it remains on the display and the drive is unlocked until the next time the power supply is disconnected. PIN code 2 is an unlock code known only to Schneider Electric Product Support. When [PIN code 2] (C O d 2) is not set to [OFF] (O F F) , the [1.2 MONITORING] (M O n -) menu is the only one visible. Then if [PIN code 2] (C O d 2) is set to [OFF] (O F F) (drive unlocked), all menus are visible. If the display settings are modified in [3.4 DISPLAY CONFIG.] (d C F -) menu, and if [PIN code 2] (C O d 2) is not set to [OFF] (O F F) , the visibility configured is kept. Then if [PIN code 2] (C O d 2) is set to OFF (drive unlocked), the visibility configured in [3.4 DISPLAY CONFIG.] (d C F -) menu is kept. | [OFF] (O F F) to 9,999 | [OFF] (O F F) |
| U L r | [Upload rights] Reads or copies the current configuration to the drive. | | [Permitted] (U L r O) |
| U L r O U L r I | [Permitted] (U L r O) : The current drive configuration can be uploaded to the graphic display terminal or PC Software. [Not allowed] (U L r I) : The current drive configuration can only be uploaded to the graphic display terminal or PC Software if the drive is not protected by an access code or if the correct code has been entered. | | |
| d L r | [Download rights] Writes the current configuration to the drive or downloads a configuration to the drive. | | [Unlock. drv] (d L r I) |
| d L r O d L r I d L r 2 d L r 3 | [Locked drv] (d L r O) : A configuration file can only be downloaded to the drive if the drive is protected by an access code, which is the same as the access code for the configuration to be downloaded. [Unlock. drv] (d L r I) : A configuration file can be downloaded to the drive or a configuration in the drive can be modified if the drive is unlocked (access code entered) or is not protected by an access code. [Not allowed] (d L r 2) : Download not authorized. [Lock/unlock] (d L r 3) : Combination of [Locked drv.] (d L r O) and [Unlock. drv] (d L r I) . | | |

Multipoint Screen



Multipoint Screen

Communication is possible between a graphic display terminal and a number of drives connected on the same bus. The addresses of the drives must be configured in advance in the **[COMMUNICATION] (C D P -)** menu using the **[Modbus Address] (R d d)** parameter, page 257.

When a number of drives are connected to the same graphic display terminal, it automatically displays the following screens:

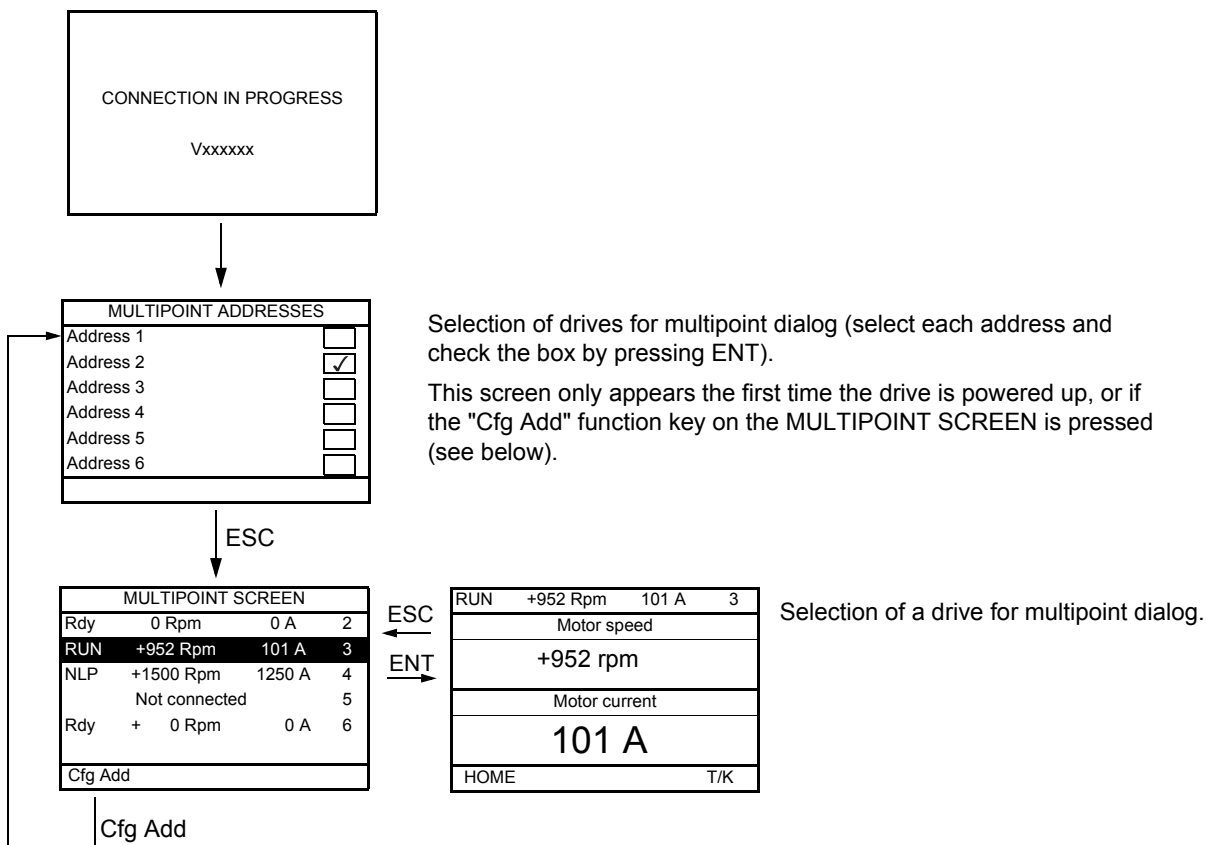

Selection of drives for multipoint dialog (select each address and check the box by pressing ENT).

This screen only appears the first time the drive is powered up, or if the "Cfg Add" function key on the MULTIPOINT SCREEN is pressed (see below).

Selection of a drive for multipoint dialog.

In multipoint mode, the command channel is not displayed. From left to right, the state, then the 2 selected parameters, and finally the drive address appear.

All menus can be accessed in multipoint mode. Only drive control via the graphic display terminal is not authorized, apart from the Stop key, which locks all the drives.

If there is a trip on a drive, this drive is displayed.

Maintenance and Diagnostics



What's in this Part?

This part contains the following chapters:

| Chapter | Chapter Name | Page |
|---------|---------------------------------|---------------------|
| 10 | Maintenance | 287 |
| 11 | Diagnostics and Troubleshooting | 289 |

Maintenance

10

Limitation of Warranty

The warranty does not apply if the product has been opened, except by Schneider Electric services.

Servicing

CAUTION

RISK OF DAMAGE TO THE DRIVE

Adapt the following recommendations according to the environment conditions: temperature, chemical, dust.

Failure to follow these instructions can result in equipment damage.

It is recommended to do the following in order to optimize continuity of operation.

| Environment | Part concerned | Action | Periodicity |
|----------------------|--|--|---|
| Knock on the product | Housing - control block (led - display) | Check the drive visual aspect | At least each year |
| Corrosion | Terminals - connector - screws - EMC plate | Inspect and clean if required | |
| Dust | Terminals - fans - blowholes | | |
| Temperature | Around the product | Check and correct if required | |
| Cooling | Fan | Check the fan operation | After 3 to 5 years, depending on the operating conditions |
| | | Replace the fan | |
| Vibration | Terminal connections | Check tightening at recommended torque | At least each year |

Note: The fan operation depends on the drive thermal state. The drive may be running and the fan not.

Spares and repairs

Serviceable product. Please refer to your Customer Care Centre.

Long time storage

The product capacitor performances after a long time storage above 2 years can be degraded. See page [10](#).

Fan replacement

It is possible to order a new fan for the ATV32 maintenance, see the commercial references on www.schneider-electric.com.

Please refer to Installation manual to replace the fan.

Diagnostics and Troubleshooting

11

What's in this Chapter?

This chapter contains the following topics:

| Topic | Page |
|---|---------------------|
| Error code | 290 |
| Clearing the detected fault | 290 |
| Fault detection codes which require a power reset after the detected fault is cleared | 291 |
| Fault detection codes that can be cleared with the automatic restart function after the cause has disappeared | 293 |
| Fault detection codes that are cleared as soon as their cause disappears | 295 |
| Option card changed or removed | 295 |
| Control block changed | 295 |
| Fault detection codes displayed on the remote display terminal | 296 |

DANGER

HAZARD OF ELECTRIC SHOCK, EXPLOSION OR ARC FLASH

Read and understand the precautions in "About the book" chapter, before performing any procedure in this section.

Failure to follow these instructions will result in death or serious injury.

Error code

- If the display does not light up, check the power supply to the drive.
- The assignment of the Fast stop or Freewheel functions will help to prevent the drive starting if the corresponding logic inputs are not powered up. The ATV32 then displays **[Freewheel]** (*n 5 E*) in freewheel stop and **[Fast stop]** (*F 5 E*) in fast stop. This is normal since these functions are active at zero so that the drive will be stopped if there is a wire break.
- Check that the run command input is activated in accordance with the selected control mode (**[2/3 wire control]** (*E C C*) and **[2 wire type]** (*E C E*) parameters, page [73](#)).
- If an input is assigned to the limit switch function and this input is at zero, the drive can only be started up by sending a command for the opposite direction (see page [209](#)).
- If the reference channel or command channel is assigned to a communication bus, when the power supply is connected, the drive will display **[Freewheel]** (*n 5 E*) and remain in stop mode until the communication bus sends a command.

| Code | Name / Description |
|----------------|---|
| <i>d G E -</i> | [DIAGNOSTICS] This menu can only be accessed with the graphic display terminal. It displays detected faults and their cause in plain text and can be used to carry out tests, see page 58 . |

Clearing the detected fault

In the event of a non resettable detected fault:

- Disconnect all power, including external control power that may be present.
- Lock all power disconnects in the open position.
- Wait 15 minutes to allow the DC bus capacitors to discharge (the drive LEDs are not indicators of the absence of DC bus voltage).
- Measure the voltage of the DC bus between the PA/+ and PC/- terminals to ensure that the voltage is less than 42 Vdc.
- If the DC bus capacitors do not discharge completely, contact your local Schneider Electric representative. Do not repair or operate the drive.
- Find and correct the detected fault.
- Restore power to the drive to confirm the detected fault has been rectified.

In the event of a resettable detected fault, the drive can be reset after the cause is cleared:

- By switching off the drive until the display disappears completely, then switching on again.
- Automatically in the scenarios described for the **[AUTOMATIC RESTART]** (*R E r -*) function, page [234](#).
- By means of a logic input or control bit assigned to the **[FAULT RESET]** (*r 5 E -*) function, page [232](#).
- By pressing the STOP/RESET key on the graphic display keypad if the active channel command is the HMI (see **[Cmd channel 1]** (*C d I*) page [140](#)).

Fault detection codes which require a power reset after the detected fault is cleared

The cause of the detected fault must be removed before resetting by turning off and then back on.

ASF, *brF*, *SDF*, *SPF* and *tnF* detected faults can also be cleared remotely by means of a logic input or control bit (**[Fault reset]** (*rSF*) parameter, page 232).

| Detected Fault | Name | Probable cause | Remedy |
|----------------|----------------------------------|--|---|
| <i>ASF</i> | [Angle Error] | <ul style="list-style-type: none"> For the law [Sync. mot.] (<i>SYn</i>), wrong setting of the speed loop, when the reference goes through 0. | <ul style="list-style-type: none"> Check the speed loop parameters. Check the motor phases and the maximum current allowed by the drive. |
| <i>brF</i> | [Brake feedback] | <ul style="list-style-type: none"> The brake feedback contact does not match the brake logic control. The brake does not stop the motor quickly enough (detected by measuring the speed on the "Pulse input" input). | <ul style="list-style-type: none"> Check the feedback circuit and the brake logic control circuit. Check the mechanical state of the brake. Check the brake linings. |
| <i>CrFI</i> | [Precharge] | <ul style="list-style-type: none"> Charging relay control detected fault or charging resistor damaged. | <ul style="list-style-type: none"> Turn the drive off and then turn on again. Check the internal connections. Contact Schneider Electric Product Support. |
| <i>EEF1</i> | [Control Eeprom] | <ul style="list-style-type: none"> Internal memory detected fault, control block. | <ul style="list-style-type: none"> Check the environment (electromagnetic compatibility). Turn off, reset, return to factory settings. |
| <i>EEF2</i> | [Power Eeprom] | <ul style="list-style-type: none"> Internal memory detected fault, power card. | <ul style="list-style-type: none"> Contact Schneider Electric Product Support. |
| <i>FCFI</i> | [Out. contact. stuck] | <ul style="list-style-type: none"> The output contactor remains closed although the opening conditions have been met. | <ul style="list-style-type: none"> Check the contactor and its wiring. Check the feedback circuit. |
| <i>HdF</i> | [IGBT desaturation] | <ul style="list-style-type: none"> Short-circuit or grounding at the drive output. | <ul style="list-style-type: none"> Check the cables connecting the drive to the motor, and the motor insulation. |
| <i>ILF</i> | [internal com. link] | <ul style="list-style-type: none"> Communication interruption between option card and drive. | <ul style="list-style-type: none"> Check the environment (electromagnetic compatibility). Check the connections. Replace the option card. Contact Schneider Electric Product Support. |
| <i>InF1</i> | [Rating error] | <ul style="list-style-type: none"> The power card is different from the card stored. | <ul style="list-style-type: none"> Check the reference of the power card. |
| <i>InF2</i> | [Incompatible PB] | <ul style="list-style-type: none"> The power card is incompatible with the control block. | <ul style="list-style-type: none"> Check the reference of the power card and its compatibility. |
| <i>InF3</i> | [Internal serial link] | <ul style="list-style-type: none"> Communication interruption between the internal cards. | <ul style="list-style-type: none"> Check the internal connections. Contact Schneider Electric Product Support. |
| <i>InF4</i> | [Internal-mfg zone] | <ul style="list-style-type: none"> Internal data inconsistent. | <ul style="list-style-type: none"> Recalibrate the drive (performed by Schneider Electric Product Support). |
| <i>InF6</i> | [Internal - fault option] | <ul style="list-style-type: none"> The option installed in the drive is not recognized. | <ul style="list-style-type: none"> Check the reference and compatibility of the option. |
| <i>InF9</i> | [Internal- I measure] | <ul style="list-style-type: none"> The current measurements are incorrect. | <ul style="list-style-type: none"> Replace the current sensors or the power card. Contact Schneider Electric Product Support. |
| <i>InFA</i> | [Internal-mains circuit] | <ul style="list-style-type: none"> The input stage is not operating correctly. | <ul style="list-style-type: none"> Contact Schneider Electric Product Support. |
| <i>InFb</i> | [Internal- th. sensor] | <ul style="list-style-type: none"> The drive temperature sensor is not operating correctly. | <ul style="list-style-type: none"> Replace the drive temperature sensor. Contact Schneider Electric Product Support. |
| <i>InFE</i> | [internal- CPU] | <ul style="list-style-type: none"> Internal microprocessor detected fault. | <ul style="list-style-type: none"> Turn off and reset. Contact Schneider Electric Product Support. |
| <i>OCF</i> | [Overcurrent] | <ul style="list-style-type: none"> Parameters in the [SETTINGS] (<i>SEt -</i>) and [MOTOR CONTROL] (<i>drC -</i>) menus are not correct. Inertia or load too high. Mechanical locking. | <ul style="list-style-type: none"> Check the parameters. Check the size of the motor/drive/load. Check the state of the mechanism. Decrease [Current limitation] (<i>CL I</i>). Increase the switching frequency. |
| <i>SFFF</i> | [Safe function fault] | <ul style="list-style-type: none"> Debounce time exceeded. SS1 trip threshold exceeded. Wrong configuration. | <ul style="list-style-type: none"> Check the safety functions configuration. Contact Schneider Electric Product Support. |

| Detected Fault | Name | Probable cause | Remedy |
|----------------|-------------------------------|---|---|
| S C F 1 | [Motor short circuit] | <ul style="list-style-type: none"> Short-circuit or grounding at the drive output. | <ul style="list-style-type: none"> Check the cables connecting the drive to the motor, and the motor insulation. Reduce the switching frequency. Connect chokes in series with the motor. Check the adjustment of speed loop and brake. Increase the [Time to restart] (t t r), page 88. Increase the switching frequency. |
| S C F 3 | [Ground short circuit] | <ul style="list-style-type: none"> Significant earth leakage current at the drive output if several motors are connected in parallel. | <ul style="list-style-type: none"> Check the cables connecting the drive to the motor, and the motor insulation. Reduce the switching frequency. Connect chokes in series with the motor. Check the adjustment of speed loop and brake. Increase the [Time to restart] (t t r), page 88. Reduce the switching frequency. |
| S O F | [Overspeed] | <ul style="list-style-type: none"> Instability or driving load too high. | <ul style="list-style-type: none"> Check the motor, gain and stability parameters. Add a braking resistor. Check the size of the motor/drive/load. Check the parameters settings for the [FREQUENCY METER] (F 9 F -) function page 247, if it is configured. |
| S P F | [Speed fdback loss] | <ul style="list-style-type: none"> Signal on "Pulse input" missing, if the input is used for speed measurement. | <ul style="list-style-type: none"> Check the wiring of the input cable and the detector used. |
| t n F | [Auto-tuning] | <ul style="list-style-type: none"> Special motor or motor whose power is not suitable for the drive. Motor not connected to the drive. Motor not stopped | <ul style="list-style-type: none"> Check that the motor/drive are compatible. Check that the motor is present during auto-tuning. If an output contactor is being used, close it during auto-tuning. Check that the motor is stopped during tune operation. |

Fault detection codes that can be cleared with the automatic restart function after the cause has disappeared

These detected faults can also be cleared by turning on and off or by means of a logic input or control bit ([**Fault reset**] (*r 5 F*) parameter page [232](#)).

| Detected Fault | Name | Probable cause | Remedy |
|----------------|--------------------------------|---|--|
| <i>b L F</i> | [Brake control] | <ul style="list-style-type: none"> Brake release current not reached. Brake engage frequency threshold [Brake engage freq] (<i>b E n</i>) only regulated when brake logic control is assigned. | <ul style="list-style-type: none"> Check the drive/motor connection. Check the motor windings. Check the [Brake release I FW] (<i>I b r</i>) and [Brake release I Rev] (<i>I r d</i>) settings page 179. Apply the recommended settings for [Brake engage freq] (<i>b E n</i>). |
| <i>C n F</i> | [Com. network] | <ul style="list-style-type: none"> Communication interruption on communication card. | <ul style="list-style-type: none"> Check the environment (electromagnetic compatibility). Check the wiring. Check the time-out. Replace the option card. Contact Schneider Electric Product Support. |
| <i>C O F</i> | [CANopen com.] | <ul style="list-style-type: none"> Communication interruption on the CANopen® bus. | <ul style="list-style-type: none"> Check the communication bus. Check the time-out. Refer to the CANopen® User's manual. |
| <i>E P F 1</i> | [External flt-LI/Bit] | <ul style="list-style-type: none"> Event triggered by an external device, depending on user. | <ul style="list-style-type: none"> Check the device which caused the trip and reset. |
| <i>E P F 2</i> | [External fault com.] | <ul style="list-style-type: none"> Event triggered by a communication network. | <ul style="list-style-type: none"> Check for the cause of the trip and reset. |
| <i>F b E 5</i> | [FB stop flt.] | <ul style="list-style-type: none"> Function blocks have been stopped while motor was running. | <ul style="list-style-type: none"> Check [FB Stop mode] (<i>F b 5 n</i>) configuration. |
| <i>F C F 2</i> | [Out. contact. open.] | <ul style="list-style-type: none"> The output contactor remains open although the closing conditions have been met. | <ul style="list-style-type: none"> Check the contactor and its wiring. Check the feedback circuit. |
| <i>L C F</i> | [input contactor] | <ul style="list-style-type: none"> The drive is not turned on even though [Mains V. time out] (<i>L C E</i>) has elapsed. | <ul style="list-style-type: none"> Check the contactor and its wiring. Check the time-out. Check the line/contactor/drive connection. |
| <i>L F F 3</i> | [AI3 4-20mA loss] | <ul style="list-style-type: none"> Loss of the 4-20 mA reference on analog input AI3. | <ul style="list-style-type: none"> Check the connection on the analog inputs. |
| <i>O b F</i> | [Overbraking] | <ul style="list-style-type: none"> Braking too sudden or driving load. Line voltage too high. | <ul style="list-style-type: none"> Increase the deceleration time. Install a braking resistor if necessary. Activate the [Dec ramp adapt.] (<i>b r A</i>) function page 157, if it is compatible with the application. Check the line voltage. |
| <i>O H F</i> | [Drive overheat] | <ul style="list-style-type: none"> Drive temperature too high. | <ul style="list-style-type: none"> Check the motor load, the drive ventilation and the ambient temperature. Wait for the drive to cool down before restarting. |
| <i>O L C</i> | [Proc. overload flt] | <ul style="list-style-type: none"> Process overload. | <ul style="list-style-type: none"> Check and remove the cause of the overload. Check the parameters of the [PROCESS OVERLOAD] (<i>O L d -</i>) function, page 253. |
| <i>O L F</i> | [Motor overload] | <ul style="list-style-type: none"> Triggered by excessive motor current. | <ul style="list-style-type: none"> Check the setting of the motor thermal protection, check the motor load. Wait for the motor to cool down before restarting. |
| <i>O P F 1</i> | [1 output phase loss] | <ul style="list-style-type: none"> Loss of one phase at drive output. | <ul style="list-style-type: none"> Check the connections from the drive to the motor. |

| Detected Fault | Name | Probable cause | Remedy |
|----------------|------------------------------|--|--|
| OPF2 | [3 motor phase loss] | <ul style="list-style-type: none"> • Motor not connected or motor power too low. • Output contactor open. • Instantaneous instability in the motor current. | <ul style="list-style-type: none"> • Check the connections from the drive to the motor. • If an output contactor is being used, set [Output Phase Loss] (OPL) to [Output cut] (ORC), page 238. • Test on a low power motor or without a motor: In factory settings mode, motor phase loss detection is active [Output Phase Loss] (OPL) = [Yes] (YES). To check the drive in a test or maintenance environment, without having to use a motor with the same rating as the drive (in particular for high power drives), deactivate motor phase loss detection [Output Phase Loss] (OPL) = [No] (ND), see instructions given page 238. • Check and optimize the following parameters: [IR compensation] (UFR) page 78, [Rated motor volt.] (Un5) and [Rated mot. current] (nCr) page 74 and perform [Auto tuning] (tUn) page 75. |
| OSF | [Mains overvoltage] | <ul style="list-style-type: none"> • Line voltage too high. • Disturbed mains supply. | <ul style="list-style-type: none"> • Check the line voltage. |
| OLEL | [LI6=PTC overheat] | <ul style="list-style-type: none"> • Overheating of PTC probes detected on input LI6. | <ul style="list-style-type: none"> • Check the motor load and motor size. • Check the motor ventilation. • Wait for the motor to cool before restarting. • Check the type and state of the PTC probes. |
| PEFL | [LI6=PTC probe] | <ul style="list-style-type: none"> • PTC probe on input LI6 open or short-circuited. | <ul style="list-style-type: none"> • Check the PTC probe and the wiring between it and the motor/drive. |
| SCF4 | [IGBT short circuit] | <ul style="list-style-type: none"> • Power component detected fault. | <ul style="list-style-type: none"> • Contact Schneider Electric Product Support. |
| SCF5 | [Motor short circuit] | <ul style="list-style-type: none"> • Short-circuit at drive output. | <ul style="list-style-type: none"> • Check the cables connecting the drive to the motor, and the motor's insulation. • Contact Schneider Electric Product Support. |
| SLF1 | [Modbus com.] | <ul style="list-style-type: none"> • Communication interruption on the Modbus bus. | <ul style="list-style-type: none"> • Check the communication bus. • Check the time-out. • Refer to the Modbus User's manual. |
| SLF2 | [PC com.] | <ul style="list-style-type: none"> • Communication interruption with PC Software. | <ul style="list-style-type: none"> • Check the PC Software connecting cable. • Check the time-out. |
| SLF3 | [HMI com.] | <ul style="list-style-type: none"> • Communication interruption with the graphic display terminal or remote display terminal. | <ul style="list-style-type: none"> • Check the terminal connection • Check the time-out. |
| SSF | [Torque/current lim] | <ul style="list-style-type: none"> • Switch to torque or current limitation. | <ul style="list-style-type: none"> • Check if there are any mechanical problems. • Check the parameters of [TORQUE LIMITATION] (tDL -) page 202 and the parameters of the [TORQUE OR I LIM. DETECT.] (tId -), page 245. |
| tJF | [IGBT overheat] | <ul style="list-style-type: none"> • Drive overheated. | <ul style="list-style-type: none"> • Check the size of the load/motor/drive. • Reduce the switching frequency. • Wait for the motor to cool before restarting. |
| ULLF | [Proc. underload Flt] | <ul style="list-style-type: none"> • Process underload. | <ul style="list-style-type: none"> • Check and remove the cause of the underload. • Check the parameters of the [PROCESS UNDERLOAD] (UId -) function, page 251. |

Fault detection codes that are cleared as soon as their cause disappears

| Detected Fault | Name | Probable cause | Remedy |
|---------------------------|-----------------------------|---|--|
| CFF | [Incorrect config.] | <ul style="list-style-type: none"> Option card changed or removed. Control block replaced by a control block configured on a drive with a different rating. The current configuration is inconsistent. | <ul style="list-style-type: none"> Check that there are no card errors. In the event of the option card being changed/removed deliberately, see the remarks below. Check that there are no card errors. In the event of the control block being changed deliberately, see the remarks below. Return to factory settings or retrieve the backup configuration, if it is valid (see page 69). |
| CFI CFI2 | [Invalid config.] | <ul style="list-style-type: none"> Invalid configuration. The configuration loaded in the drive via the bus or communication network is inconsistent. | <ul style="list-style-type: none"> Check the configuration loaded previously. Load a compatible configuration. |
| CSF | [Ch. Sw. fault] | <ul style="list-style-type: none"> Switch to not valid channels. | <ul style="list-style-type: none"> Check the function parameters. |
| dLF | [Dynamic load fault] | <ul style="list-style-type: none"> Abnormal load variation. | <ul style="list-style-type: none"> Check that the load is not blocked by an obstacle. Removal of a run command causes a reset. |
| FbE | [FB fault] | <ul style="list-style-type: none"> Function blocks error. | <ul style="list-style-type: none"> See [FB Fault] (FbFE) for more details. |
| HCF | [Cards pairing] | <ul style="list-style-type: none"> The [CARDS PAIRING] (PPI-) function page 250 has been configured and a drive card has been changed. | <ul style="list-style-type: none"> In the event of a card error, reinsert the original card. Confirm the configuration by entering the [Pairing password] (PPI) if the card was changed deliberately. |
| PHF | [Input phase loss] | <ul style="list-style-type: none"> Drive incorrectly supplied or a fuse blown. One phase missing. 3-phase ATV32 used on a single-phase line supply. Unbalanced load. This protection only operates with the drive on load. | <ul style="list-style-type: none"> Check the power connection and the fuses. Use a 3-phase line supply. Disable the detected fault by [Input phase loss] (IPL) = [No] (nD) page 74. |
| USF | [Undervoltage] | <ul style="list-style-type: none"> Line supply too low. Transient voltage dip. | <ul style="list-style-type: none"> Check the voltage and the parameters of [UNDERVOLTAGE MGT] (U5b-), page 241. |

Option card changed or removed

When an option card is removed or replaced by another, the drive locks in **[Incorrect config.] (CFF)** fault mode on power-up. If the card has been deliberately changed or removed, the detected fault can be cleared by pressing the ENT key twice, which causes the factory settings to be restored (see page 69) for the parameter groups affected by the card. These are as follows:

Card replaced by a card of the same type

- Communication cards: only the parameters that are specific to communication cards

Control block changed

When a control block is replaced by a control block configured on a drive with a different rating, the drive locks in **[Incorrect config.] (CFF)** fault mode on power-up. If the control block has been deliberately changed, the detected fault can be cleared by pressing the ENT key twice, which **causes all the factory settings to be restored.**

Fault detection codes displayed on the remote display terminal

| Code | Name | Description |
|------------------------|--|---|
| <i>In I E</i> | [Initialization in progress] | The microcontroller is initializing. Search underway for communication configuration. |
| <i>C O N. E</i> (1) | [Communication error] | Time out detected fault (50 ms). This message is displayed after 20 attempts at communication. |
| <i>A - 1 7</i> (1) | [Alarm button] | A key has been held down for more than 10 seconds. The keypad is disconnected. The keypad wakes up when a key is pressed. |
| <i>C L r</i> (1) | [Confirmation of detected fault reset] | This is displayed when the STOP key is pressed once if the active command channel is the remote display terminal. |
| <i>d E U. E</i> (1) | [Drive disparity] | The drive brand does not match that of the remote display terminal. |
| <i>r O N. E</i> (1) | [ROM anomaly] | The remote display terminal detects a ROM anomaly on the basis of checksum calculation. |
| <i>r A N. E</i> (1) | [RAM anomaly] | The remote display terminal detects a RAM anomaly. |
| <i>C P U. E</i> (1) | [Other detected faults] | Other detected faults. |

(1) Flashing

Annex



IV

What's in this Part?

This part contains the following chapters:

| Chapter | Chapter Name | Page |
|---------|--------------------------|---------------------|
| 12 | Index of Functions | 299 |
| 13 | Index of Parameter Codes | 301 |

Index of Functions

The following table represents the parameter codes:

| Function | Page |
|--|---------------------|
| [2 wire] (2C) | 73 |
| [2nd CURRENT LIMIT.] | 204 |
| [3 wire] (3C) | 73 |
| [+/- SPEED] | 170 |
| [+/-SPEED AROUND REF.] | 172 |
| [AUTO DC INJECTION] | 161 |
| [AUTOMATIC RESTART] | 234 |
| [Auto tuning] | 75 |
| [AUTO TUNING BY LI] | 221 |
| [BRAKE LOGIC CONTROL] | 179 |
| [CATCH ON THE FLY] | 235 |
| Command and reference channels | 131 |
| Deferred stop on thermal alarm | 240 |
| [DRIVE OVERHEAT] | 239 |
| [FACTORY SETTINGS] | 69 |
| [Fault reset] | 232 |
| [FLUXING BY LI] | 174 |
| [HIGH SPEED HOISTING] | 190 |
| [JOG] | 163 |
| LINE CONTACTOR COMMAND | 205 |
| Load measurement | 184 |
| [Load sharing] | 109 |
| Load variation detection | 248 |
| Motor or configuration switching [MULTIMOTORS/CONFIG.] (MPC -) | 217 |
| Motor thermal protection | 236 |
| [Noise reduction] | 107 |
| [OUTPUT CONTACTOR CMD] | 208 |
| [Ovld.Proces.Mngmt] | 253 |
| [PARAM. SET SWITCHING] | 215 |
| [5 PASSWORD] | 282 |
| [PID REGULATOR] | 196 |
| POSITIONING BY SENSORS | 209 |
| PRESET SPEEDS | 165 |
| PTC probe | 232 |
| [RAMP] | 155 |
| [REFERENCE SWITCH.] | 152 |
| Rope slack | 189 |
| [RP assignment] | 115 |
| REFERENCE MEMORIZING | 173 |
| [STOP CONFIGURATION] | 158 |
| Stop at distance calculated after deceleration limit switch | 211 |

| Function | Page |
|--|---------------------|
| Summing input / Subtracting input / Multiplier | 153 |
| Synchronous motor parameters | 99 |
| TORQUE LIMITATION | 201 |
| TRAVERSE CONTROL | 222 |
| [Underload Managmt.] | 252 |
| Use of the "Pulse input" input to measure the speed of rotation of the motor | 246 |

Index of Parameter Codes

13

The following table represents the parameter codes:

| Code | | | | | | | | | | | | | | | CUSTOMER SETTING |
|-------------|---------------------------------|----------------------------|------------------------------|--------------------------------|--------------------------|---------------------|---------------------------|----------------------------------|---------------------|-----------------------------|--|------------------------------|---------------------------|-------------------------|------------------|
| | [1.1 SPEED REFERENCE] (rEF-) | [1.2 MONITORING] (MOn-) | [FACTORY SETTINGS] (FLS-) | [Macro configuration] (CFG) | [SIMPLY START] (SIP-) | [SETTINGS] (SE-) | [MOTOR CONTROL] (MCL-) | [INPUTS / OUTPUTS CFG] (IOP-) | [COMMAND] (CLL-) | [FUNCTION BLOCKS] (FBP-) | [APPLICATION FUNCT.] (FUN-) | [FAULT MANAGEMENT] (FLM-) | [COMMUNICATION] (COP-) | [3 INTERFACE] (IEF-) | |
| <i>ACC</i> | | | | | | <u>77</u> | | | | | <u>156</u> <u>172</u> <u>198</u> | | | | |
| <i>ACC</i> | | | | | <u>75</u> | <u>77</u> | | | | | <u>155</u> | | | | |
| <i>AdC</i> | | | | | | | | | | | <u>161</u> | | | | |
| <i>AdCO</i> | | | | | | | | | | | | | <u>258</u> | | |
| <i>Add</i> | | | | | | | | | | | | | <u>257</u> | | |
| <i>A11A</i> | | <u>46</u> | | | | | | <u>120</u> | | | | | | | |
| <i>A11C</i> | | <u>46</u> | | | | | | | | | | | | | |
| <i>A11E</i> | | | | | | | | <u>121</u> | | | | | | | |
| <i>A11F</i> | | <u>46</u> | | | | | | <u>121</u> | | | | | | | |
| <i>A11S</i> | | | | | | | | <u>120</u> | | | | | | | |
| <i>A11t</i> | | | | | | | | <u>120</u> | | | | | | | |
| <i>A12A</i> | | <u>46</u> | | | | | | <u>120</u> | | | | | | | |
| <i>A12C</i> | | <u>46</u> | | | | | | | | | | | | | |
| <i>A12E</i> | | | | | | | | <u>121</u> | | | | | | | |
| <i>A12F</i> | | <u>46</u> | | | | | | <u>121</u> | | | | | | | |
| <i>A12S</i> | | | | | | | | <u>121</u> | | | | | | | |
| <i>A12t</i> | | | | | | | | <u>120</u> | | | | | | | |
| <i>A13A</i> | | <u>47</u> | | | | | | <u>121</u> | | | | | | | |
| <i>A13C</i> | | <u>47</u> | | | | | | | | | | | | | |
| <i>A13E</i> | | | | | | | | <u>121</u> | | | | | | | |
| <i>A13F</i> | | <u>47</u> | | | | | | <u>121</u> | | | | | | | |
| <i>A13L</i> | | | | | | | | <u>121</u> | | | | | | | |
| <i>A13S</i> | | | | | | | | <u>121</u> | | | | | | | |
| <i>A13t</i> | | | | | | | | <u>121</u> | | | | | | | |
| <i>A1C2</i> | | | | | | | | <u>122</u> | | | <u>196</u> | | | | |
| <i>A1U1</i> | <u>40</u> | <u>44</u> | | | | | | | | | | | | | |
| <i>ALGr</i> | | <u>57</u> | | | | | | | | | | | | | |
| <i>ANOC</i> | | | | | | | | | | | | | <u>257</u> | | |
| <i>AD1</i> | | <u>47</u> | | | | | | <u>129</u> | | | | | | | |
| <i>AD1C</i> | | <u>47</u> | | | | | | | | | | | | | |
| <i>AD1F</i> | | <u>47</u> | | | | | | <u>129</u> | | | | | | | |

| Code | | | | | | | | | | | | | | | | CUSTOMER SETTING |
|------|---------------------------------|----------------------------|------------------------------|--------------------------------|--------------------------|---------------------|---------------------------|---------------------------------|---------------------|-----------------------------|--------------------------------|-----------------------------|---------------------------|-------------------------|--|------------------|
| | [1.1 SPEED REFERENCE] (rFF-) | [1.2 MONITORING] (nOn-) | [FACTORY SETTINGS] (FLS-) | [Macro configuration] (CFG) | [SIMPLY START] (SIP-) | [SETTINGS] (SE-) | [MOTOR CONTROL] (MCL-) | [INPUTS / OUTPUTS CFG] (ID-) | [COMMAND] (CLL-) | [FUNCTION BLOCKS] (FBP-) | [APPLICATION FUNCT.] (FUN-) | [FAULT MANAGEMENT] (FL-) | [COMMUNICATION] (COP-) | [3 INTERFACE] (IEF-) | | |
| ADIt | | | | | | | | 129 | | | | | | | | |
| ADH1 | | 47 | | | | | | 129 | | | | | | | | |
| ADL1 | | 47 | | | | | | 129 | | | | | | | | |
| APH | | 56 | | | | | | | | | | | | | | |
| ASH1 | | 47 | | | | | | 129 | | | | | | | | |
| ASL1 | | 47 | | | | | | 129 | | | | | | | | |
| ASt | | | | | | | 101 | | | | 175 | | | | | |
| At | | | | | | | | | | | | 234 | | | | |
| AUt | | | | | | | 96 101 | | | | | | | | | |
| AU1A | | | | | | | | 121 | | | | | | | | |
| AU2A | | | | | | | | 122 | | | | | | | | |
| bCl | | | | | | | | | | | 179 | | | | | |
| bCd | | | | | | | | | | | | | 258 | | | |
| bEd | | | | | | | | | | | 180 | | | | | |
| bEn | | | | | | 88 | | | | | 180 | | | | | |
| bEt | | | | | | 88 | | | | | 180 | | | | | |
| bFr | | | | | 74 | | 92 | | | | | | | | | |
| bIP | | | | | | | | | | | 179 | | | | | |
| bIr | | | | | | 88 | | | | | 180 | | | | | |
| bLc | | | | | | | | | | | 179 | | | | | |
| bNP | | | | | | | | | 142 | | | | | | | |
| bNS | | 49 | | | | | | | | 143 | | | | | | |
| bNU | | 49 | | | | | | | | 143 | | | | | | |
| bOA | | | | | | | 107 | | | | | | | | | |
| bOO | | | | | | | 107 | | | | | | | | | |
| brA | | | | | | | | | | | 157 | | | | | |
| brHO | | | | | | | | | | | 182 | | | | | |
| brH1 | | | | | | | | | | | 182 | | | | | |
| brH2 | | | | | | | | | | | 183 | | | | | |
| br | | | | | | | | | | | 183 | | | | | |
| brt | | | | | | 88 | | | | | 179 | | | | | |
| bSP | | | | | | | | 118 | | | | | | | | |
| bSt | | | | | | | | | | | 179 | | | | | |
| btPI | | | | | | | | | | | | | 258 | | | |
| btUA | | | | | | | | | | | | | 258 | | | |
| btUC | | | | | | | | | | | | | 258 | | | |
| bUEr | | 49 | | | | | | | | 143 | | | | | | |
| CCFG | | | | | 74 | | | | | | | | | | | |
| CCS | | | | | | | | | 140 | | | | | | | |
| Cd1 | | | | | | | | | 140 | | | | | | | |
| Cd2 | | | | | | | | | 140 | | | | | | | |
| CFG | | | | 70 | 73 | | | | | | | | | | | |

| Code | [1.1 SPEED REFERENCE] (rFF-) | [1.2 MONITORING] (nOn-) | [FACTORY SETTINGS] (FLS-) | [Macro configuration] (CFG) | [SIMPLY START] (SIN-) | [SETTINGS] (SE-) | [MOTOR CONTROL] (MCL-) | [INPUTS / OUTPUTS CFG] (I-O-) | [COMMAND] (CLL-) | [FUNCTION BLOCKS] (FBn-) | [APPLICATION FUNCT.] (FUN-) | [FAULT MANAGEMENT] (FL-) | [COMMUNICATION] (CON-) | [3 INTERFACE] (IEF-) | CUSTOMER SETTING |
|-------|---------------------------------|----------------------------|------------------------------|--------------------------------|--------------------------|---------------------|---------------------------|----------------------------------|---------------------|-----------------------------|--------------------------------|-----------------------------|---------------------------|-------------------------|------------------|
| CFPS | | 56 | | | | | | | | | | | | | |
| CHAR1 | | | | | | | | | | | 215 | | | | |
| CHAR2 | | | | | | | | | | | 215 | | | | |
| CHCF | | | | | | | | | 139 | | | | | | |
| CHN | | | | | | | | | | | 220 | | | | |
| CL2 | | | | | | 83 | | | | | 204 | | | | |
| CL1 | | | | | | 82 | 106 | | | | 204 | | | | |
| CLL | | | | | | | | | | | | 243 | | | |
| CLD | | | | | | | | | | | 190 | | | | |
| CLS | | | | | | | | | | | 213 | | | | |
| CONC | | 50 | | | | | | | | | | | | | |
| CONF1 | | | | | | | | | | | 220 | | | | |
| CONF2 | | | | | | | | | | | 220 | | | | |
| CONF5 | | 56 | | | | | | | | | | | | | |
| COd | | 63 | | | | | | | | | | | | | |
| COd2 | | 63 | | | | | | | | | | | | | |
| COF | | | | | | | | | | | 190 | | | | |
| COL | | | | | | | | | | | | 244 | | | |
| COP | | | | | | | | | 141 | | | | | | |
| COr | | | | | | | | | | | 190 | | | | |
| CO5 | | | | | | | 94 | | | | | | | | |
| CP1 | | | | | | | | | | | 185 | | | | |
| CP2 | | | | | | | | | | | 185 | | | | |
| CRH3 | | 47 | | | | | | 121 | | | | | | | |
| CRL3 | | 47 | | | | | | 121 | | | | | | | |
| CRSt | | | | | | | | | | | | | | 275 | |
| CRtF | | | | | | | 105 | | | | | | | | |
| CSbY | | | | | | | | | | | | | | 275 | |
| CSb | | 63 | | | | | | | | | | | | 282 | |
| Ctd | | | | | | 89 | | | | | | 234 | | | |
| Ctt | | | | | | | 92 | | | | | | | | |
| CtU | | 49 | | | | | | | | 143 | | | | | |
| dA2 | | | | | | | | | | | 153 | | | | |
| dA3 | | | | | | | | | | | 154 | | | | |
| dAF | | | | | | | | | | | 212 | | | | |
| dAL | | | | | | | | | | | 212 | | | | |
| dAr | | | | | | | | | | | 212 | | | | |
| dAS | | | | | | | | | | | 208 | | | | |
| db5 | | | | | | | | | | | 208 | | | | |
| dCC1 | | 60 | | | | | | | | | | | | | |
| dCC2 | | 60 | | | | | | | | | | | | | |
| dCC3 | | 60 | | | | | | | | | | | | | |

| Code | | | | | | | | | | | | | | | | | CUSTOMER SETTING |
|------|---------------------------------|----------------------------|------------------------------|--------------------------------|--------------------------|---------------------|---------------------------|---------------------------------|---------------------|-----------------------------|--------------------------------|-----------------------------|---------------------------|-------------------------|--|--|------------------|
| | [1.1 SPEED REFERENCE] (rFF-) | [1.2 MONITORING] (nOn-) | [FACTORY SETTINGS] (FLS-) | [Macro configuration] (CFG) | [SIMPLY START] (SIN-) | [SETTINGS] (SE-) | [MOTOR CONTROL] (MCL-) | [INPUTS / OUTPUTS CFG] (ID-) | [COMMAND] (CLL-) | [FUNCTION BLOCKS] (FbN-) | [APPLICATION FUNCT.] (FUN-) | [FAULT MANAGEMENT] (FL-) | [COMMUNICATION] (CON-) | [3 INTERFACE] (IEF-) | | | |
| dCC4 | 60 | | | | | | | | | | | | | | | | |
| dCC5 | 60 | | | | | | | | | | | | | | | | |
| dCC6 | 60 | | | | | | | | | | | | | | | | |
| dCC7 | 60 | | | | | | | | | | | | | | | | |
| dCC8 | 60 | | | | | | | | | | | | | | | | |
| dCF | | | | | | 81 | | | | | 158 | 254 | | | | | |
| dC1 | | | | | | | | | | | 159 | | | | | | |
| dE2 | | | | | | 77 | | | | | 156 | | | | | | |
| dE3 | | | | | 75 | 77 | | | | | 172 | | | | | | |
| dLb | | | | | | | | | | | | 248 | | | | | |
| dLd | | | | | | | | | | | | 248 | | | | | |
| dLr | 63 | | | | | | | | | | | | | 282 | | | |
| dD1 | | | | | | | | 126 | | | | | | | | | |
| dD1d | | | | | | | | 126 | | | | | | | | | |
| dD1H | | | | | | | | 126 | | | | | | | | | |
| dD1S | | | | | | | | 126 | | | | | | | | | |
| dP1 | 58 | | | | | | | | | | | | | | | | |
| dP2 | 60 | | | | | | | | | | | | | | | | |
| dP3 | 60 | | | | | | | | | | | | | | | | |
| dP4 | 60 | | | | | | | | | | | | | | | | |
| dP5 | 60 | | | | | | | | | | | | | | | | |
| dP6 | 60 | | | | | | | | | | | | | | | | |
| dP7 | 60 | | | | | | | | | | | | | | | | |
| dPB | 60 | | | | | | | | | | | | | | | | |
| drC1 | 60 | | | | | | | | | | | | | | | | |
| drC2 | 60 | | | | | | | | | | | | | | | | |
| drC3 | 60 | | | | | | | | | | | | | | | | |
| drC4 | 60 | | | | | | | | | | | | | | | | |
| drC5 | 60 | | | | | | | | | | | | | | | | |
| drC6 | 60 | | | | | | | | | | | | | | | | |
| drC7 | 60 | | | | | | | | | | | | | | | | |
| drC8 | 60 | | | | | | | | | | | | | | | | |
| d5F | | | | | | | | | | | 213 | | | | | | |
| d51 | | | | | | | | | | | 172 | | | | | | |
| d5P | | | | | | | | | | | 172 | | | | | | |
| d5F | | | | | | | | | | | 228 | | | | | | |
| EbD | | | | | | | | | | | 227 | | | | | | |
| EPL | | | | | | | | | | | | 241 | | | | | |
| ErCD | | | | | | | | | | | | | 258 | | | | |
| E5F | | | | | | | | | | | 240 | | | | | | |
| F1 | | | | | | | 105 | | | | | | | | | | |
| F2 | | | | | | | 105 | | | | | | | | | | |

| Code | | | | | | | | | | | | | | | CUSTOMER SETTING |
|------|---------------------------------|----------------------------|------------------------------|--------------------------------|--------------------------|---------------------|---------------------------|----------------------------------|---------------------|-----------------------------|--------------------------------|------------------------------|---------------------------|-------------------------|------------------|
| | [1.1 SPEED REFERENCE] (rEF-) | [1.2 MONITORING] (nOn-) | [FACTORY SETTINGS] (FLS-) | [Macro configuration] (CFG) | [SIMPLY START] (SIN-) | [SETTINGS] (SE-) | [MOTOR CONTROL] (MCL-) | [INPUTS / OUTPUTS CFG] (IOD-) | [COMMAND] (CLL-) | [FUNCTION BLOCKS] (FBP-) | [APPLICATION FUNCT.] (FUN-) | [FAULT MANAGEMENT] (FLM-) | [COMMUNICATION] (CON-) | [3 INTERFACE] (IEF-) | |
| F2d | | | | | | | 89 | | | | | | | | |
| F3 | | | | | | | 106 | | | | | | | | |
| F4 | | | | | | | 106 | | | | | | | | |
| F5 | | | | | | | 106 | | | | | | | | |
| FAb | | | | | | | 107 | | | | | | | | |
| FAd1 | | | | | | | | | | | | | | 268 | |
| FAd2 | | | | | | | | | | | | | | 268 | |
| FAd3 | | | | | | | | | | | | | | 268 | |
| FAd4 | | | | | | | | | | | | | | 268 | |
| FbCd | | | | | | | | | | 143 | | | | | |
| Fbdf | | | | | | | | | | 144 | | | | | |
| FbFt | | 49 | | | | | | | | 143 | | | | | |
| Fbrn | | | | | | | | | | 144 | | | | | |
| FbSn | | | | | | | | | | 144 | | | | | |
| FbSt | | 49 | | | | | | | | 143 | | | | | |
| FcS1 | | | 69 | | | | | | | | | | | | |
| Fdt | | | | | | | | | | | | 247 | | | |
| FFH | | | | | | | 105 | | | | | | | | |
| FFn | | | | | | 91 | | | | | | | | | |
| FFt | | | | | | 89 | | | | | 158 | | | | |
| FL1 | | | | | | | | | | | 174 | | | | |
| FL0 | | | | | | | | | | | | | 259 | | |
| FL0C | | | | | | | | | | | | | 259 | | |
| FL0t | | | | | | | | | | | | | 259 | | |
| FLr | | | | | | | | | | | | 235 | | | |
| FLU | | | | | | 83 | 96 | | | | 174 | | | | |
| Fn1 | | | | | | | | | 142 | | | | | | |
| Fn2 | | | | | | | | | 142 | | | | | | |
| Fn3 | | | | | | | | | 142 | | | | | | |
| Fn4 | | | | | | | | | 142 | | | | | | |
| FP1 | | | | | | | | | | | 198 | | | | |
| F9A | | | | | | | | | | | | 247 | | | |
| F9C | | | | | | | | | | | | 247 | | | |
| F9F | | | | | | | | | | | | 247 | | | |
| F9L | | | | | | 89 | | | | | | 235 | | | |
| F95 | | 44 | | | | | | | | | | | | | |
| F9t | | | | | | | | | | | | 247 | | | |
| Fr1 | | | | | | | | | 139 | | | | | | |
| Fr1b | | | | | | | | | | | 152 | | | | |
| Fr2 | | | | | | | | | 140 | | | | | | |
| FrH | 44 | 44 50 | | | | | | | | | | | | | |
| Fr1 | | | | | | | 103 | | | | | | | | |

| Code | | | | | | | | | | | | | | CUSTOMER SETTING | |
|------|---------------------------------|----------------------------|------------------------------|--------------------------------|--------------------------|---------------------|---------------------------|---------------------------------|--------------------|----------------------------|--------------------------------|------------------------------|---------------------------|-------------------------|--|
| | [1.1 SPEED REFERENCE] (rEF-) | [1.2 MONITORING] (MOn-) | [FACTORY SETTINGS] (FLS-) | [Macro configuration] (CFG) | [SIMPLY START] (SIP-) | [SETTINGS] (SE-) | [MOTOR CONTROL] (MCL-) | [INPUTS / OUTPUTS CFG] (ID-) | [COMMAND] (CL-) | [FUNCTION BLOCKS] (FB-) | [APPLICATION FUNCT.] (FUN-) | [FAULT MANAGEMENT] (FLM-) | [COMMUNICATION] (COM-) | [3 INTERFACE] (IEF-) | |
| Fr5 | | | | | <u>74</u> | | <u>94</u> | | | | | | | | |
| Fr55 | | | | | | | <u>103</u> | | | | | | | | |
| FrE | | | | | | | | | | | <u>156</u> | | | | |
| FSt | | | | | | | | | | | <u>158</u> | | | | |
| FEd | | | | | | <u>89</u> | | | | | | | <u>234</u> | | |
| FED | | | | | | <u>90</u> | | | | | | | <u>253</u> | | |
| FtU | | | | | | <u>90</u> | | | | | | | <u>252</u> | | |
| FtY | | | <u>69</u> | | | | | | | | | | | | |
| GF5 | | | <u>69</u> | | | | | | | | | | | | |
| GSP | | | | | | | | | | | | | | <u>271</u> | |
| HFI | | | | | | | <u>102</u> | | | | | | | | |
| Hlr | | | | | | | <u>103</u> | | | | | | | | |
| H50 | | | | | | | | | | | <u>190</u> | | | | |
| H5P | | | | | <u>75</u> | <u>77</u> | | | | | <u>229</u> | | | | |
| H5P2 | | | | | | <u>78</u> | | | | | <u>229</u> | | | | |
| H5P3 | | | | | | <u>78</u> | | | | | <u>229</u> | | | | |
| H5P4 | | | | | | <u>78</u> | | | | | <u>229</u> | | | | |
| IA01 | | | | | | | | | | <u>145</u> | | | | | |
| IA02 | | | | | | | | | | <u>145</u> | | | | | |
| IA03 | | | | | | | | | | <u>145</u> | | | | | |
| IA04 | | | | | | | | | | <u>145</u> | | | | | |
| IA05 | | | | | | | | | | <u>145</u> | | | | | |
| IA06 | | | | | | | | | | <u>145</u> | | | | | |
| IA07 | | | | | | | | | | <u>145</u> | | | | | |
| IA08 | | | | | | | | | | <u>145</u> | | | | | |
| IA09 | | | | | | | | | | <u>145</u> | | | | | |
| IA10 | | | | | | | | | | <u>145</u> | | | | | |
| IAd1 | | | | | | | | | | | | | | <u>268</u> | |
| IAd2 | | | | | | | | | | | | | | <u>268</u> | |
| IAd3 | | | | | | | | | | | | | | <u>268</u> | |
| IAd4 | | | | | | | | | | | | | | <u>268</u> | |
| Ibr | | | | | | <u>88</u> | | | | | <u>179</u> | | | | |
| IbrA | | | | | | | | | | | <u>185</u> | | | | |
| IbA | | | | | | | <u>98</u> | | | | | | | | |
| IbC | | | | | | <u>81</u> | | | | | <u>159</u> | <u>254</u> | | | |
| IbC2 | | | | | | <u>81</u> | | | | | <u>160</u> | <u>254</u> | | | |
| IL01 | | | | | | | | | | <u>144</u> | | | | | |
| IL02 | | | | | | | | | | <u>144</u> | | | | | |
| IL03 | | | | | | | | | | <u>144</u> | | | | | |
| IL04 | | | | | | | | | | <u>144</u> | | | | | |
| IL05 | | | | | | | | | | <u>144</u> | | | | | |
| IL06 | | | | | | | | | | <u>144</u> | | | | | |

| Code | | | | | | | | | | | | | | | | | CUSTOMER SETTING |
|------|---------------------------------|----------------------------|------------------------------|--------------------------------|--------------------------|---------------------|---------------------------|----------------------------------|---------------------|-----------------------------|--------------------------------|------------------------------|---------------------------|-------------------------|--|--|------------------|
| | [1.1 SPEED REFERENCE] (rFF-) | [1.2 MONITORING] (nOn-) | [FACTORY SETTINGS] (FLS-) | [Macro configuration] (CFG) | [SIMPLY START] (SIP-) | [SETTINGS] (SE-) | [MOTOR CONTROL] (MCL-) | [INPUTS / OUTPUTS CFG] (IOD-) | [COMMAND] (CLL-) | [FUNCTION BLOCKS] (FBP-) | [APPLICATION FUNCT.] (FUN-) | [FAULT MANAGEMENT] (FLM-) | [COMMUNICATION] (COP-) | [3 INTERFACE] (IEF-) | | | |
| IL07 | | | | | | | | | | 144 | | | | | | | |
| IL08 | | | | | | | | | | 144 | | | | | | | |
| IL09 | | | | | | | | | | 144 | | | | | | | |
| IL10 | | | | | | | | | | 144 | | | | | | | |
| ILr | | | | | | | 103 | | | | | | | | | | |
| InH | | | | | | | | | | | | 243 | | | | | |
| Inr | | | | | | 77 | | | | | 155 | | | | | | |
| InbP | | | | | | | | | | | 202 | | | | | | |
| IPL | | | | | 74 | | | | | | | 238 | | | | | |
| IRD | | | | | | 88 | | | | | 179 | | | | | | |
| IEH | | | | | 75 | 78 | | | | | | | | | | | |
| JdC | | | | | | 88 | | | | | 181 | | | | | | |
| JF2 | | | | | | 90 | | | | | 168 | | | | | | |
| JF3 | | | | | | 90 | | | | | 168 | | | | | | |
| JFH | | | | | | 90 | | | | | 168 | | | | | | |
| JGF | | | | | | 83 | | | | | 163 | | | | | | |
| JGt | | | | | | 83 | | | | | 164 | | | | | | |
| JOG | | | | | | | | | | | 163 | | | | | | |
| JPF | | | | | | 90 | | | | | 168 | | | | | | |
| L1A | 45 | | | | | | | 114 | | | | | | | | | |
| L1d | | | | | | | | 115 | | | | | | | | | |
| L2A | 45 | | | | | | | 115 | | | | | | | | | |
| L2d | | | | | | | | 115 | | | | | | | | | |
| L3A | 45 | | | | | | | 114 | | | | | | | | | |
| L3d | | | | | | | | 115 | | | | | | | | | |
| L4A | 45 | | | | | | | 115 | | | | | | | | | |
| L4d | | | | | | | | 115 | | | | | | | | | |
| L5A | 45 | | | | | | | 114 | | | | | | | | | |
| L5d | | | | | | | | 115 | | | | | | | | | |
| L6A | 45 | | | | | | | 115 | | | | | | | | | |
| L6d | | | | | | | | 115 | | | | | | | | | |
| LAD1 | | | | | | | | | | 145 | | | | | | | |
| LAD2 | | | | | | | | | | 145 | | | | | | | |
| LAD3 | | | | | | | | | | 145 | | | | | | | |
| LAD4 | | | | | | | | | | 145 | | | | | | | |
| LAD5 | | | | | | | | | | 145 | | | | | | | |
| LAD6 | | | | | | | | | | 145 | | | | | | | |
| LAD7 | | | | | | | | | | 145 | | | | | | | |
| LAD8 | | | | | | | | | | 145 | | | | | | | |
| LARA | 45 | | | | | | | 115 | | | | | | | | | |
| LARd | | | | | | | | 115 | | | | | | | | | |
| LARA | 45 | | | | | | | 115 | | | | | | | | | |

| Code | | | | | | | | | | | | | | | CUSTOMER SETTING |
|---------|---------------------------------|----------------------------|------------------------------|--------------------------------|--------------------------|---------------------|---------------------------|----------------------------------|---------------------|-----------------------------|--------------------------------|-----------------------------|---------------------------|-------------------------|------------------|
| | [1.1 SPEED REFERENCE] (rFF-) | [1.2 MONITORING] (nDn-) | [FACTORY SETTINGS] (FLS-) | [Macro configuration] (CFG) | [SIMPLY START] (SIN-) | [SETTINGS] (SE-) | [MOTOR CONTROL] (MCL-) | [INPUTS / OUTPUTS CFG] (I-O-) | [COMMAND] (CLL-) | [FUNCTION BLOCKS] (FBn-) | [APPLICATION FUNCT.] (FUN-) | [FAULT MANAGEMENT] (FL-) | [COMMUNICATION] (CON-) | [3 INTERFACE] (IEF-) | |
| L A 2 d | | | | | | | | 115 | | | | | | | |
| L A C | | | | | | | | | | | | | | 262 | |
| L b A | | | | | | | 109 | | | | | | | | |
| L b C | | | | | | 91 | 109 | | | | | | | | |
| L b C 1 | | | | | | | 111 | | | | | | | | |
| L b C 2 | | | | | | | 111 | | | | | | | | |
| L b C 3 | | | | | | | 111 | | | | | | | | |
| L b F | | | | | | | 111 | | | | | | | | |
| L C 2 | | | | | | | | | | | 204 | | | | |
| L C r | | 44 | | | | | | | | | | | | | |
| L C t | | | | | | | | | | | 206 | | | | |
| L d 5 | | | | | | | 103 | | | | | | | | |
| L E 5 | | | | | | | | | | | 206 | | | | |
| L E t | | | | | | | | | | | | 240 | | | |
| L F A | | | | | | | 98 | | | | | | | | |
| L F F | | | | | | | | | | | | | 253 | | |
| L F L 3 | | | | | | | | | | | | | 242 | | |
| L F r | 40 | 44 | | | | | | | | | | | | | |
| L F r 1 | | 53 | | | | | | | | | | | | | |
| L F r 2 | | 53 | | | | | | | | | | | | | |
| L F r 3 | | 53 | | | | | | | | | | | | | |
| L I 5 1 | | 45 | | | | | | | | | | | | | |
| L I 5 2 | | 45 | | | | | | | | | | | | | |
| L L C | | | | | | | | | | | 206 | | | | |
| L n G | | | | | | | | | | | | | | 264 | |
| L O 1 | | | | | | | | | 124 | | | | | | |
| L O 1 d | | | | | | | | | 124 | | | | | | |
| L O 1 H | | | | | | | | | 125 | | | | | | |
| L O 1 S | | | | | | | | | 124 | | | | | | |
| L O C | | | | | | 90 | | | | | | | 253 | | |
| L P 1 | | | | | | | | | | | 185 | | | | |
| L P 2 | | | | | | | | | | | 185 | | | | |
| L 9 5 | | | | | | | 103 | | | | | | | | |
| L 5 P | | | | | 75 | 77 | | | | | | | | | |
| L U L | | | | | | 90 | | | | | | 251 | | | |
| L U n | | | | | | 90 | | | | | | 251 | | | |
| n 0 0 1 | | | | | | | | | | 146 | | | | | |
| n 0 0 2 | | | | | | | | | | 146 | | | | | |
| n 0 0 3 | | | | | | | | | | 146 | | | | | |
| n 0 0 4 | | | | | | | | | | 146 | | | | | |
| n 0 0 5 | | | | | | | | | | 146 | | | | | |
| n 0 0 6 | | | | | | | | | | 146 | | | | | |

| Code | | | | | | | | | | | | | | | CUSTOMER SETTING |
|------|---------------------------------|----------------------------|------------------------------|--------------------------------|--------------------------|---------------------|---------------------------|----------------------------------|---------------------|-----------------------------|--------------------------------|------------------------------|---------------------------|-------------------------|------------------|
| | [1.1 SPEED REFERENCE] (rFF-) | [1.2 MONITORING] (nOn-) | [FACTORY SETTINGS] (FLS-) | [Macro configuration] (CFG) | [SIMPLY START] (SIP-) | [SETTINGS] (SE-) | [MOTOR CONTROL] (MCL-) | [INPUTS / OUTPUTS CFG] (IOD-) | [COMMAND] (CLL-) | [FUNCTION BLOCKS] (FBP-) | [APPLICATION FUNCT.] (FUN-) | [FAULT MANAGEMENT] (FLM-) | [COMMUNICATION] (COP-) | [3 INTERFACE] (IEF-) | |
| n007 | | | | | | | | | | 146 | | | | | |
| n008 | | | | | | | | | | 146 | | | | | |
| n1Ct | | 52 | | | | | | | | | | | | | |
| n1Ec | | 52 | | | | | | | | | | | | | |
| n3Ct | | 52 | | | | | | | | | | | | | |
| n3Ec | | 52 | | | | | | | | | | | | | |
| nA2 | | | | | | | | | | | | 154 | | | |
| nA3 | | | | | | | | | | | | 154 | | | |
| nCr | | | | | | | 103 | | | | | | | | |
| nDt | | | | | | | | | | | | | | 267 | |
| nFr | 40 | 44 | | | | 85 | | | | | | | | | |
| nPC | | | | | | | 97 | | | | | | | | |
| nE0 | | | | | | | | | | | | 237 | | | |
| nbrP | | 55 | | | | | | | | | | | | | |
| nbtP | | 55 | | | | | | | | | | | | | |
| nC1 | | 53 | | | | | | | | | | | | | |
| nC2 | | 53 | | | | | | | | | | | | | |
| nC3 | | 53 | | | | | | | | | | | | | |
| nC4 | | 53 | | | | | | | | | | | | | |
| nC5 | | 53 | | | | | | | | | | | | | |
| nC6 | | 53 | | | | | | | | | | | | | |
| nC7 | | 53 | | | | | | | | | | | | | |
| nC8 | | 53 | | | | | | | | | | | | | |
| nCA1 | | | | | | | | | | | | | 257 | | |
| nCA2 | | | | | | | | | | | | | 257 | | |
| nCA3 | | | | | | | | | | | | | 257 | | |
| nCA4 | | | | | | | | | | | | | 257 | | |
| nCA5 | | | | | | | | | | | | | 257 | | |
| nCA6 | | | | | | | | | | | | | 257 | | |
| nCA7 | | | | | | | | | | | | | 257 | | |
| nCA8 | | | | | | | | | | | | | 257 | | |
| nCr | | | | | 74 | | 94 | | | | | | | | |
| nCr5 | | | | | | | 99 | | | | | | | | |
| nL5 | | | | | | | | | | | 213 | | | | |
| nP1 | | 52 | | | | | | | | | | | | | |
| nP2 | | 52 | | | | | | | | | | | | | |
| nP3 | | 52 | | | | | | | | | | | | | |
| nP4 | | 52 | | | | | | | | | | | | | |
| nP5 | | 52 | | | | | | | | | | | | | |
| nP6 | | 52 | | | | | | | | | | | | | |
| nP7 | | 52 | | | | | | | | | | | | | |
| nP8 | | 52 | | | | | | | | | | | | | |

| Code | | | | | | | | | | | | | | | CUSTOMER SETTING |
|------|---------------------------------|----------------------------|------------------------------|--------------------------------|--------------------------|---------------------|---------------------------|---------------------------------|---------------------|-----------------------------|--------------------------------|-----------------------------|---------------------------|-------------------------|------------------|
| | [1.1 SPEED REFERENCE] (rFF-) | [1.2 MONITORING] (nDn-) | [FACTORY SETTINGS] (FLS-) | [Macro configuration] (CFG) | [SIMPLY START] (SIN-) | [SETTINGS] (SE-) | [MOTOR CONTROL] (MCL-) | [INPUTS / OUTPUTS CFG] (ID-) | [COMMAND] (CLL-) | [FUNCTION BLOCKS] (FBn-) | [APPLICATION FUNCT.] (FUN-) | [FAULT MANAGEMENT] (FL-) | [COMMUNICATION] (CON-) | [3 INTERFACE] (IEF-) | |
| nPA1 | | | | | | | | | | | | | | 256 | |
| nPA2 | | | | | | | | | | | | | | 256 | |
| nPA3 | | | | | | | | | | | | | | 256 | |
| nPA4 | | | | | | | | | | | | | | 256 | |
| nPA5 | | | | | | | | | | | | | | 256 | |
| nPA6 | | | | | | | | | | | | | | 256 | |
| nPA7 | | | | | | | | | | | | | | 256 | |
| nPA8 | | | | | | | | | | | | | | 257 | |
| nPE5 | | 55 | | | | | | | | | | | | | |
| nPr | | | | | 74 | | 94 | | | | | | | | |
| nrd | | | | | | | 107 | | | | | | | | |
| nSP | | | | | 74 | | 94 | | | | | | | | |
| nSPS | | | | | | | 99 | | | | | | | | |
| nSt | | | | | | | | | | | 158 | | | | |
| DL | | | | | | | | | | | 208 | | | | |
| dL | | | | | | | | | | | | 253 | | | |
| dE | | | | | | | | | | | | 238 | | | |
| DHL | | | | | | | | | | | | 239 | | | |
| DLL | | | | | | | | | | | | 237 | | | |
| DPL | | | | | | | | | | | | 238 | | | |
| DPr | | 44 | | | | | | | | | | | | | |
| DSP | | | | | | | | | | | 190 | | | | |
| DEr | | 44 | | | | | | | | | | | | | |
| PAH | | | | | | 86 | | | | | 198 | | | | |
| PAL | | | | | | 86 | | | | | 197 | | | | |
| PAS | | | | | | | | | | | 213 | | | | |
| PAU | | | | | | | | | | | 198 | | | | |
| PCd | | | | | | | | | | | | | | 274 | |
| PEr | | | | | | 86 | | | | | 198 | | | | |
| PE5 | | | | | | | | | | | 185 | | | | |
| PFI | | 48 | | | | | | 115 | | | | | | | |
| PFr | | 48 | | | | | | 115 | | | | | | | |
| PH5 | | | | | | | 103 | | | | | | | | |
| PIA | | 48 | | | | | | 115 | | | | | | | |
| PIC | | | | | | | | | | | 197 | | | | |
| PIF | | | | | | | | | | | 196 | | | | |
| PIF1 | | | | | | | | | | | 196 | | | | |
| PIF2 | | | | | | | | | | | 196 | | | | |
| PII | | | | | | | | | | | 196 | | | | |
| PIL | | 48 | | | | | | 115 | | | | | | | |
| PIH | | | | | | | | | | | 199 | | | | |
| PIPI | | | | | | | | | | | 196 | | | | |

| Code | | | | | | | | | | | | | | | | CUSTOMER SETTING |
|------|---------------------------------|----------------------------|------------------------------|--------------------------------|--------------------------|---------------------|---------------------------|----------------------------------|---------------------|-----------------------------|--------------------------------|-----------------------------|---------------------------|-------------------------|--|------------------|
| | [1.1 SPEED REFERENCE] (rEF-) | [1.2 MONITORING] (nOn-) | [FACTORY SETTINGS] (FLS-) | [Macro configuration] (CFG) | [SIMPLY START] (SIN-) | [SETTINGS] (SE-) | [MOTOR CONTROL] (MCL-) | [INPUTS / OUTPUTS CFG] (IOD-) | [COMMAND] (CLL-) | [FUNCTION BLOCKS] (FbN-) | [APPLICATION FUNCT.] (FUN-) | [FAULT MANAGEMENT] (FL-) | [COMMUNICATION] (CON-) | [3 INTERFACE] (IEF-) | | |
| PIP2 | | | | | | | | | | | 196 | | | | | |
| PI5 | | | | | | | | | | | 198 | | | | | |
| PDH | | | | | | 86 | | | | | 197 | | | | | |
| PDL | | | | | | 86 | | | | | 197 | | | | | |
| PP1 | | | | | | | | | | | | 250 | | | | |
| PPn5 | | | | | | | 99 | | | | | | | | | |
| Pr2 | | | | | | | | | | | 200 | | | | | |
| Pr4 | | | | | | | | | | | 200 | | | | | |
| PrP | | | | | | 86 | | | | | 197 | | | | | |
| PS16 | | | | | | | | | | | 166 | | | | | |
| PS2 | | | | | | | | | | | 166 | | | | | |
| PS4 | | | | | | | | | | | 166 | | | | | |
| PS8 | | | | | | | | | | | 166 | | | | | |
| PSr | | | | | | 86 | | | | | 198 | | | | | |
| PSε | | | | | | | | | 139 | | | | | | | |
| PtCL | | | | | | | | | | | | 232 | | | | |
| PtH | | 56 | | | | | | | | | | | | | | |
| PU15 | | | | | | | | | | | | | | 274 | | |
| q5H | | | | | | 89 | | | | | 227 | | | | | |
| q5L | | | | | | 89 | | | | | 227 | | | | | |
| r1 | | | | | | | | 123 | | | | | | | | |
| r1d | | | | | | | | 123 | | | | | | | | |
| r1H | | | | | | | | 124 | | | | | | | | |
| r15 | | | | | | | | 123 | | | | | | | | |
| r2 | | | | | | | | 124 | | | | | | | | |
| r2d | | | | | | | | 124 | | | | | | | | |
| r2H | | | | | | | | 124 | | | | | | | | |
| r25 | | | | | | | | 124 | | | | | | | | |
| rCA | | | | | | | | | | | 208 | | | | | |
| rCb | | | | | | | | | | | 152 | | | | | |
| rDG | | | | | | 86 | | | | | 197 | | | | | |
| rEC1 | | 55 | | | | | | | | | | | | | | |
| rFC | | | | | | | | | 140 | | | | | | | |
| rFCC | | 50 | | | | | | | | | | | | | | |
| rFLε | | 62 | | | | | | | | | | | | | | |
| rFr | | 44 | | | | | | | | | | | | | | |
| rIG | | | | | | 86 | | | | | 197 | | | | | |
| rIn | | | | | | | | | 139 | | | | | | | |
| rNUd | | | | | | 90 | | | | | | 251 | | | | |
| rP | | | | | | | | | | | | 233 | | | | |
| rP11 | | 53 | | | | | | | | | | | | | | |
| rP12 | | 54 | | | | | | | | | | | | | | |

| Code | | | | | | | | | | | | | | | CUSTOMER SETTING |
|-------------|--|-------------------------------------|---------------------------------------|---|-----------------------------------|-------------------------------|------------------------------------|--|------------------------------|--------------------------------------|---|---------------------------------------|------------------------------------|----------------------------------|------------------|
| | [1.1 SPEED REFERENCE] (<i>rEF-</i>) | [1.2 MONITORING] (<i>MON-</i>) | [FACTORY SETTINGS] (<i>FLS-</i>) | [Macro configuration] (<i>CFG</i>) | [SIMPLY START] (<i>SIN-</i>) | [SETTINGS] (<i>SET-</i>) | [MOTOR CONTROL] (<i>MCL-</i>) | [INPUTS / OUTPUTS CFG] (<i>ID-</i>) | [COMMAND] (<i>CLL-</i>) | [FUNCTION BLOCKS] (<i>FBN-</i>) | [APPLICATION FUNCT.] (<i>FUN-</i>) | [FAULT MANAGEMENT] (<i>FLM-</i>) | [COMMUNICATION] (<i>CON-</i>) | [3 INTERFACE] (<i>IEF-</i>) | |
| <i>rP13</i> | | <u>54</u> | | | | | | | | | | | | | |
| <i>rP14</i> | | <u>54</u> | | | | | | | | | | | | | |
| <i>rP2</i> | | | | | | <u>86</u> | | | | | <u>200</u> | | | | |
| <i>rP21</i> | | <u>54</u> | | | | | | | | | | | | | |
| <i>rP22</i> | | <u>54</u> | | | | | | | | | | | | | |
| <i>rP23</i> | | <u>54</u> | | | | | | | | | | | | | |
| <i>rP24</i> | | <u>54</u> | | | | | | | | | | | | | |
| <i>rP3</i> | | | | | | <u>87</u> | | | | | <u>200</u> | | | | |
| <i>rP31</i> | | <u>55</u> | | | | | | | | | | | | | |
| <i>rP32</i> | | <u>55</u> | | | | | | | | | | | | | |
| <i>rP33</i> | | <u>55</u> | | | | | | | | | | | | | |
| <i>rP34</i> | | <u>55</u> | | | | | | | | | | | | | |
| <i>rP4</i> | | | | | | <u>87</u> | | | | | <u>200</u> | | | | |
| <i>rPA</i> | | | | | | | | | | | | <u>233</u> | | | |
| <i>rPC</i> | <u>40</u> | <u>56</u> | | | | | | | | | | | | | |
| <i>rPE</i> | | <u>56</u> | | | | | | | | | | | | | |
| <i>rPF</i> | | <u>56</u> | | | | | | | | | | | | | |
| <i>rPG</i> | | | | | | <u>86</u> | | | | | <u>197</u> | | | | |
| <i>rP1</i> | <u>40</u> | <u>56</u> | | | | | | | | | <u>197</u> | | | | |
| <i>rP0</i> | | <u>56</u> | | | | | | | | | | | | | |
| <i>rPr</i> | | <u>56</u> | | | | | | | | | | | | | |
| <i>rP5</i> | | | | | | | | | | | <u>156</u> | | | | |
| <i>rPt</i> | | | | | | | | | | | <u>155</u> | | | | |
| <i>rP5</i> | | | | | | | | <u>113</u> | | | | | | | |
| <i>rSA</i> | | | | | | | <u>98</u> | | | | | | | | |
| <i>rSA5</i> | | | | | | | <u>103</u> | | | | | | | | |
| <i>rSd</i> | | | | | | | | | | | <u>190</u> | | | | |
| <i>rSF</i> | | | | | | | | | | | | <u>232</u> | | | |
| <i>rSL</i> | | | | | | | | | | | <u>199</u> | | | | |
| <i>rSEL</i> | | | | | | | | | | | <u>190</u> | | | | |
| <i>rEH</i> | | <u>56</u> | | | | | | | | | | | | | |
| <i>rEr</i> | | | | | | | | | | | <u>228</u> | | | | |
| <i>rUn</i> | | | | | | | | <u>113</u> | | | | | | | |
| <i>S101</i> | | | | | | | | | | | <u>215</u> | | | | |
| <i>S102</i> | | | | | | | | | | | <u>215</u> | | | | |
| <i>S103</i> | | | | | | | | | | | <u>215</u> | | | | |
| <i>S104</i> | | | | | | | | | | | <u>215</u> | | | | |
| <i>S105</i> | | | | | | | | | | | <u>215</u> | | | | |
| <i>S106</i> | | | | | | | | | | | <u>215</u> | | | | |
| <i>S107</i> | | | | | | | | | | | <u>215</u> | | | | |
| <i>S108</i> | | | | | | | | | | | <u>215</u> | | | | |
| <i>S109</i> | | | | | | | | | | | <u>215</u> | | | | |

| Code | [1.1 SPEED REFERENCE] (rFF-) | [1.2 MONITORING] (nDn-) | [FACTORY SETTINGS] (FLS-) | [Macro configuration] (CFG) | [SIMPLY START] (SIN-) | [SETTINGS] (SE-) | [MOTOR CONTROL] (MCL-) | [INPUTS / OUTPUTS CFG] (ID-) | [COMMAND] (CLL-) | [FUNCTION BLOCKS] (FBn-) | [APPLICATION FUNCT.] (FUN-) | [FAULT MANAGEMENT] (FL-) | [COMMUNICATION] (Cn-) | [3 INTERFACE] (IEF-) | CUSTOMER SETTING |
|------|---------------------------------|----------------------------|------------------------------|--------------------------------|--------------------------|---------------------|---------------------------|---------------------------------|---------------------|-----------------------------|--------------------------------|-----------------------------|--------------------------|-------------------------|------------------|
| 5110 | | | | | | | | | | | 215 | | | | |
| 5111 | | | | | | | | | | | 215 | | | | |
| 5112 | | | | | | | | | | | 215 | | | | |
| 5113 | | | | | | | | | | | 215 | | | | |
| 5114 | | | | | | | | | | | 215 | | | | |
| 5115 | | | | | | | | | | | 215 | | | | |
| 5201 | | | | | | | | | | | 215 | | | | |
| 5202 | | | | | | | | | | | 215 | | | | |
| 5203 | | | | | | | | | | | 215 | | | | |
| 5204 | | | | | | | | | | | 215 | | | | |
| 5205 | | | | | | | | | | | 215 | | | | |
| 5206 | | | | | | | | | | | 215 | | | | |
| 5207 | | | | | | | | | | | 215 | | | | |
| 5208 | | | | | | | | | | | 215 | | | | |
| 5209 | | | | | | | | | | | 215 | | | | |
| 5210 | | | | | | | | | | | 215 | | | | |
| 5211 | | | | | | | | | | | 215 | | | | |
| 5212 | | | | | | | | | | | 215 | | | | |
| 5213 | | | | | | | | | | | 215 | | | | |
| 5214 | | | | | | | | | | | 215 | | | | |
| 5215 | | | | | | | | | | | 215 | | | | |
| 5301 | | | | | | | | | | | 216 | | | | |
| 5302 | | | | | | | | | | | 216 | | | | |
| 5303 | | | | | | | | | | | 216 | | | | |
| 5304 | | | | | | | | | | | 216 | | | | |
| 5305 | | | | | | | | | | | 216 | | | | |
| 5306 | | | | | | | | | | | 216 | | | | |
| 5307 | | | | | | | | | | | 216 | | | | |
| 5308 | | | | | | | | | | | 216 | | | | |
| 5309 | | | | | | | | | | | 216 | | | | |
| 5310 | | | | | | | | | | | 216 | | | | |
| 5311 | | | | | | | | | | | 216 | | | | |
| 5312 | | | | | | | | | | | 216 | | | | |
| 5313 | | | | | | | | | | | 216 | | | | |
| 5314 | | | | | | | | | | | 216 | | | | |
| 5315 | | | | | | | | | | | 216 | | | | |
| 5A2 | | | | | | | | | | | 153 | | | | |
| 5A3 | | | | | | | | | | | 153 | | | | |
| 5AL | | | | | | | | | | | 212 | | | | |
| 5Ar | | | | | | | | | | | 212 | | | | |
| 5At | | | | | | | | | | | | 240 | | | |
| 5CL | | | | | | | | | | | 190 | | | | |

| Code | [1.1 SPEED REFERENCE] (rFF-) | [1.2 MONITORING] (nOn-) | [FACTORY SETTINGS] (FLS-) | [Macro configuration] (CFG) | [SIMPLY START] (SIN-) | [SETTINGS] (SE-) | [MOTOR CONTROL] (MCL-) | [INPUTS / OUTPUTS CFG] (ID-) | [COMMAND] (CLL-) | [FUNCTION BLOCKS] (FbN-) | [APPLICATION FUNCT.] (FUN-) | [FAULT MANAGEMENT] (FL-) | [COMMUNICATION] (CON-) | [3 INTERFACE] (IEF-) | CUSTOMER SETTING |
|------|---------------------------------|----------------------------|------------------------------|--------------------------------|--------------------------|---------------------|---------------------------|---------------------------------|---------------------|-----------------------------|--------------------------------|-----------------------------|---------------------------|-------------------------|---------------------|
| SCS1 | | | 69 | | | | | | | | | | | | |
| SDC1 | | | | | | 81 | | | | | 161 180 | | | | |
| SDC2 | | | | | | 82 | | | | | 162 | | | | |
| SFC | | | | | | 78 | 105 | | | | | | | | |
| SFd | | | | | | | | | | | 213 | | | | |
| SFFE | | 49 | | | | | | | | | | | | | |
| SFr | | | | | | 82 | 106 | | | | | | | | |
| SFt | | | | | | | 106 | | | | | | | | |
| SH2 | | | | | | | | | | | 229 | | | | |
| SH4 | | | | | | | | | | | 229 | | | | |
| S1r | | | | | | | 104 | | | | | | | | |
| S1t | | | | | | 78 | 105 | | | | | | | | |
| SLL | | | | | | | | | | | | 244 | | | |
| SLP | | | | | | 78 | 105 | | | | | | | | |
| SLSS | | 48 | | | | | | | | | | | | | |
| SNOt | | | | | | | 101 | | | | | | | | |
| SnC | | | | | | | | | | | 228 | | | | |
| SOP | | | | | | | 107 | | | | | | | | |
| SP10 | | | | | | 84 | | | | | 167 | | | | |
| SP11 | | | | | | 84 | | | | | 167 | | | | |
| SP12 | | | | | | 84 | | | | | 167 | | | | |
| SP13 | | | | | | 85 | | | | | 167 | | | | |
| SP14 | | | | | | 85 | | | | | 167 | | | | |
| SP15 | | | | | | 85 | | | | | 167 | | | | |
| SP16 | | | | | | 85 | | | | | 167 | | | | |
| SP2 | | | | | | 84 | | | | | 166 | | | | |
| SP3 | | | | | | 84 | | | | | 166 | | | | |
| SP4 | | | | | | 84 | | | | | 166 | | | | |
| SP5 | | | | | | 84 | | | | | 166 | | | | |
| SP6 | | | | | | 84 | | | | | 166 | | | | |
| SP7 | | | | | | 84 | | | | | 166 | | | | |
| SP8 | | | | | | 84 | | | | | 167 | | | | |
| SP9 | | | | | | 84 | | | | | 167 | | | | |
| SPb | | | | | | | 103 | | | | | | | | |
| SPF | | | | | | | 103 | | | | | | | | |
| SPG | | | | | | 78 | 105 | | | | | | | | |
| SPGU | | | | | | 78 | 105 | | | | | | | | |
| SPN | | | | | | | | | | | 173 | | | | |
| Srb | | | | | | 90 | | | | | | 251 253 | | | |
| SrP | | | | | | 85 | | | | | 172 | | | | |
| SS15 | | 48 | | | | | | | | | | | | | |

| Code | [1.1 SPEED REFERENCE] (rFF-) | [1.2 MONITORING] (nOn-) | [FACTORY SETTINGS] (FLS-) | [Macro configuration] (CFG) | [SIMPLY START] (SIN-) | [SETTINGS] (SE-) | [MOTOR CONTROL] (MCL-) | [INPUTS / OUTPUTS CFG] (IOD-) | [COMMAND] (CLL-) | [FUNCTION BLOCKS] (FBn-) | [APPLICATION FUNCT.] (FUN-) | [FAULT MANAGEMENT] (FL-) | [COMMUNICATION] (CON-) | [3 INTERFACE] (IEF-) | CUSTOMER SETTING |
|------|---------------------------------|----------------------------|------------------------------|--------------------------------|--------------------------|---------------------|---------------------------|----------------------------------|---------------------|-----------------------------|--------------------------------|-----------------------------|---------------------------|-------------------------|------------------|
| SSb | | | | | | | | | | | | 245 | | | |
| Std | | | | | | | | | | | 213 | | | | |
| Stn | | | | | | | | | | | | 242 | | | |
| StO | | | | | | | | | | | | 245 | | | |
| StOS | | 48 | | | | | | | | | | | | | |
| StP | | | | | | | | | | | | 241 | | | |
| StP | | | | | | | | | | | 170 | | | | |
| StPt | | | | | | | | | | | | 242 | | | |
| Stt | | | | | | | | | | | 158 | | | | |
| StUn | | | | | 75 | | 95 100 | | | | | | | | |
| SUL | | | | | | | 107 | | | | | | | | |
| tA1 | | | | | | 77 | | | | | 155 | | | | |
| tA2 | | | | | | 77 | | | | | 156 | | | | |
| tA3 | | | | | | 77 | | | | | 156 | | | | |
| tA4 | | | | | | 77 | | | | | 156 | | | | |
| tAA | | | | | | | | | | | 202 | | | | |
| tAC | | 62 | | | | | | | | | | | | | |
| tAC2 | | 62 | | | | | | | | | | | | | |
| tAr | | | | | | | | | | | | 234 | | | |
| tBE | | | | | | 88 | | | | | 180 | | | | |
| tBD | | | | | | | | | | | 227 | | | | |
| tBr | | | | | | | | | | | | | 257 | | |
| tBS | | | | | | | | | | | | 242 | | | |
| tCC | | | | | 73 | | | 112 | | | | | | | |
| tCt | | | | | | | | 112 | | | | | | | |
| tDC | | | | | | 81 | | | | | 160 | 255 | | | |
| tDC1 | | | | | | 81 | | | | | 161 | | | | |
| tDC2 | | | | | | 82 | | | | | 162 | | | | |
| tDI | | | | | | 81 | | | | | 159 | 254 | | | |
| tDn | | | | | | | | | | | 227 | | | | |
| tDS | | | | | | | | | | | | 247 | | | |
| tEC1 | | 55 | | | | | | | | | | | | | |
| tFD | | | | | | | | | | | | | 257 | | |
| tFr | | | | | 75 | | | 92 | | | | | | | |
| tHA | | | | | | | | | | | | 239 240 | | | |
| tHd | | 44 | | | | | | | | | | | | | |
| tHr | | 44 | | | | | | | | | | | | | |
| tHt | | | | | | | | | | | | 237 | | | |
| tLA | | | | | | | | | | | 202 | | | | |
| tLC | | | | | | | | | | | 203 | | | | |
| tLd | | | | | | | | | | | | 248 | | | |

| Code | | | | | | | | | | | | | | | | CUSTOMER SETTING |
|--------|---------------------------------|----------------------------|------------------------------|--------------------------------|--------------------------|---------------------|---------------------------|---------------------------------|---------------------|----------------------------|--------------------------------|-----------------------------|---------------------------|-------------------------|--|------------------|
| | [1.1 SPEED REFERENCE] (rEF-) | [1.2 MONITORING] (nOn-) | [FACTORY SETTINGS] (FLS-) | [Macro configuration] (CFG) | [SIMPLY START] (SIN-) | [SETTINGS] (SE-) | [MOTOR CONTROL] (MCL-) | [INPUTS / OUTPUTS CFG] (ID-) | [COMMAND] (CLL-) | [FUNCTION BLOCKS] (FB-) | [APPLICATION FUNCT.] (FUN-) | [FAULT MANAGEMENT] (FL-) | [COMMUNICATION] (COP-) | [3 INTERFACE] (IEF-) | | |
| EL 1G | | | | | | 89 | | | | | 202 | | | | | |
| EL 1N | | | | | | 89 | | | | | 202 | | | | | |
| EL 5 | | | | | | 83 | | | | | 199 | | | | | |
| EnL | | | | | | | | | | | | 249 | | | | |
| EO L | | | | | | | | | | | | 253 | | | | |
| EO 5 | | | | | | | | | | | 190 | | | | | |
| EP 11 | | 54 | | | | | | | | | | | | | | |
| EP 12 | | 54 | | | | | | | | | | | | | | |
| EP 13 | | 54 | | | | | | | | | | | | | | |
| EP 14 | | 54 | | | | | | | | | | | | | | |
| EP 21 | | 54 | | | | | | | | | | | | | | |
| EP 22 | | 54 | | | | | | | | | | | | | | |
| EP 23 | | 54 | | | | | | | | | | | | | | |
| EP 24 | | 54 | | | | | | | | | | | | | | |
| EP 31 | | 55 | | | | | | | | | | | | | | |
| EP 32 | | 55 | | | | | | | | | | | | | | |
| EP 33 | | 55 | | | | | | | | | | | | | | |
| EP 34 | | 55 | | | | | | | | | | | | | | |
| Eqb | | | | | | | | | | | | 247 | | | | |
| Eq 5 | | | | | | | 99 | | | | | | | | | |
| ErA | | | | | | | 98 | | | | | | | | | |
| ErC | | | | | | | | | | | 227 | | | | | |
| ErH | | | | | | 89 | | | | | 227 | | | | | |
| ErL | | | | | | 89 | | | | | 227 | | | | | |
| ESn | | | | | | | | | | | | 241 | | | | |
| ES 4 | | | | | | | | | | | 228 | | | | | |
| Et d | | | | | | 90 | | | | | | 237 240 | | | | |
| Et d 2 | | | | | | | | | | | | 237 240 | | | | |
| Et d 3 | | | | | | | | | | | | 237 240 | | | | |
| Et H | | | | | | 89 | | | | | | 234 | | | | |
| Et L | | | | | | 89 | | | | | | 234 | | | | |
| Et O | | | | | | | | | | | | 257 | | | | |
| Et r | | | | | | 88 | | | | 181 | | | | | | |
| EU L | | | | | | | | | | 221 | | | | | | |
| EU n | | | | | 75 | | 95 100 | | | | | | | | | |
| EU n U | | | | | | | 96 101 | | | | | | | | | |
| EU P | | | | | | | | | | 227 | | | | | | |
| EU 5 | | | | | 75 | | 95 100 | | | | | | | | | |

| Code | [1.1 SPEED REFERENCE] (rFF-) | [1.2 MONITORING] (nDn-) | [FACTORY SETTINGS] (FLS-) | [Macro configuration] (CFG) | [SIMPLY START] (SIN-) | [SETTINGS] (SE-) | [MOTOR CONTROL] (MCL-) | [INPUTS / OUTPUTS CFG] (ID-) | [COMMAND] (CLL-) | [FUNCTION BLOCKS] (FbN-) | [APPLICATION FUNCT.] (FUN-) | [FAULT MANAGEMENT] (FL-) | [COMMUNICATION] (CDN-) | [3 INTERFACE] (IEF-) | CUSTOMER SETTING |
|------|---------------------------------|----------------------------|------------------------------|--------------------------------|--------------------------|---------------------|---------------------------|---------------------------------|---------------------|-----------------------------|--------------------------------|-----------------------------|---------------------------|-------------------------|------------------|
| U1 | | | | | | | 105 | | | | | | | | |
| U2 | | | | | | | 105 | | | | | | | | |
| U3 | | | | | | | 106 | | | | | | | | |
| U4 | | | | | | | 106 | | | | | | | | |
| U5 | | | | | | | 106 | | | | | | | | |
| Ubr | | | | | | | | | | | | | 109 | | |
| UdL | | | | | | | | | | | | 252 | | | |
| UFr | | | | | | 78 | 105 | | | | | | | | |
| UIH1 | | 46 | | | | | | 120 | | | | | | | |
| UIH2 | | 46 | | | | | | 121 | | | | | | | |
| UIL1 | | 46 | | | | | | 120 | | | | | | | |
| UIL2 | | 46 | | | | | | 120 | | | | | | | |
| ULn | | 44 | | | | | | | | | | | | | |
| ULr | | 63 | | | | | | | | | | | | | |
| ULt | | | | | | | | | | | | 251 | | | |
| UnS | | | | | 74 | | 94 | | | | | | | | |
| UDH1 | | 47 | | | | | | 129 | | | | | | | |
| UDL1 | | 47 | | | | | | 129 | | | | | | | |
| UDP | | 44 | | | | | | | | | | | | | |
| UPL | | | | | | | | | | | | 242 | | | |
| URES | | | | | | | | | | | | 241 | | | |
| USb | | | | | | | | | | | | 241 | | | |
| USI | | | | | | | | | | 172 | | | | | |
| USL | | | | | | | | | | | | 241 | | | |
| USP | | | | | | | | | | 170 | | | | | |
| USt | | | | | | | | | | | | 241 | | | |

