

WYŁĄCZNIKI KRAŃCOWE SERII K

**KB A1...
KM A1...**

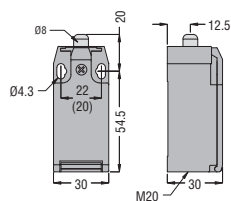

**KC A1
KN A1**

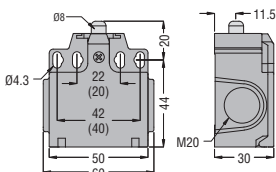

**KB B1... - KB B2...
KM B1... - KM B2...**

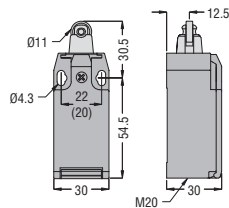

**KC B1... - KC B2...
KN B1... - KN B2...**

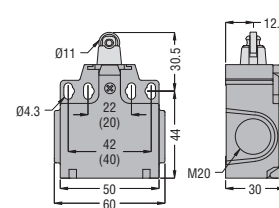

**KB C1... - KB C2...
KM C1... - KM C2...**

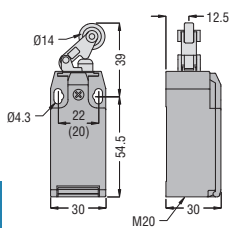

**KC C1... - KC C2...
KN C1... - KN C2...**

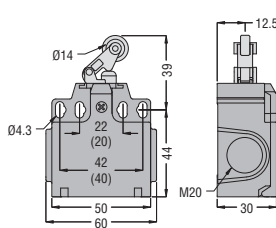

**KB D1... - KB D2...
KM D1... - KM D2...**

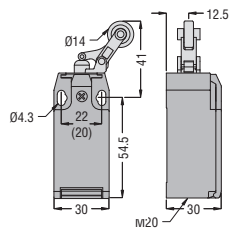

**KC D1... - KC D2...
KN D1... - KN D2...**

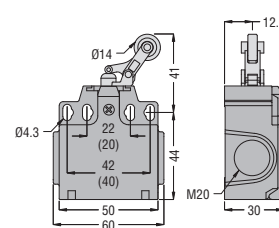

**KB E1... - KB E2...
KM E1... - KM E2...**

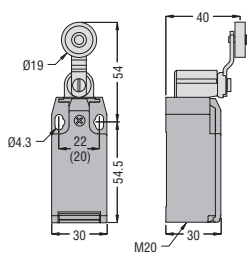

**KC E1... - KC E2...
KN E1... - KN E2...**

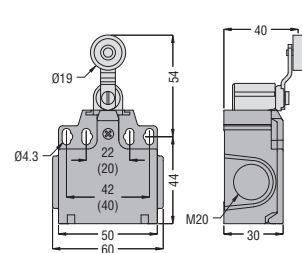

**KB E3...
KM E3...**

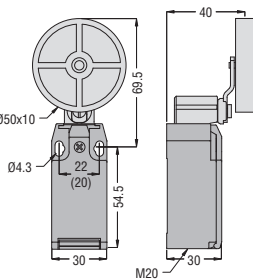

**KC E3...
KN E3...**

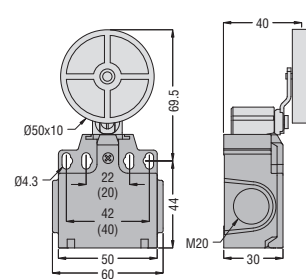

**KB F1... - KB F2...
KM F1... - KM F2...**

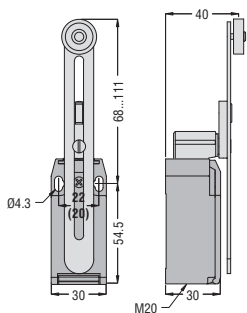

**KC F1... - KC F2...
KN F1... - KN F2...**

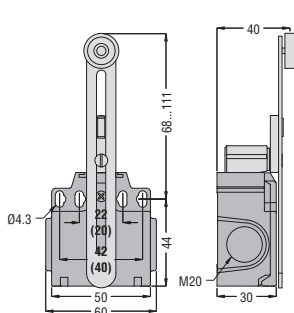

**KB F3...
KM F3...**

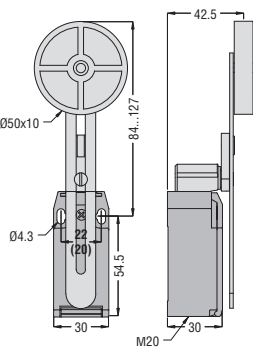

**KC F3...
KN F3...**

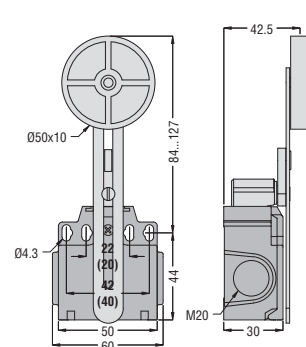

**KB F4...
KM F4...**

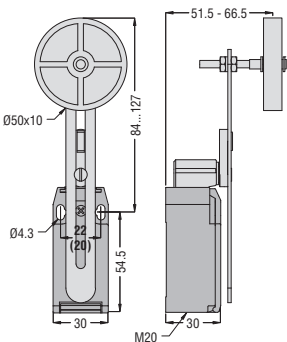

**KC F4...
KN F4...**

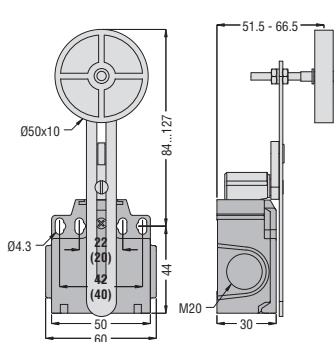

**KB H1...
KM H1...**

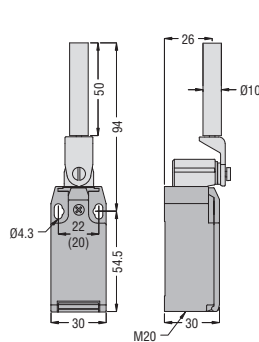

**KC H1...
KN H1...**

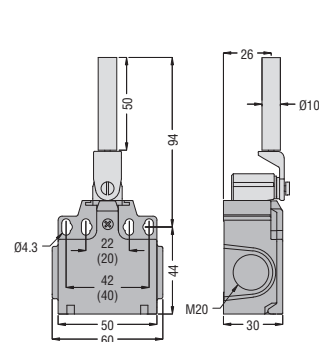

9

WYŁĄCZNIKI KRAŃCOWE SERII K

KB L1... - KB L2...
KM L1... - KM L2...

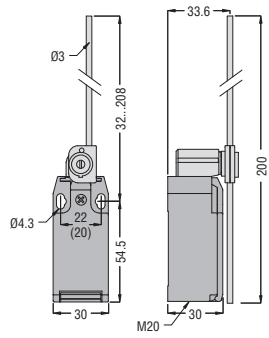

KC L1... - KC L2...
KN L1... - KN L2...

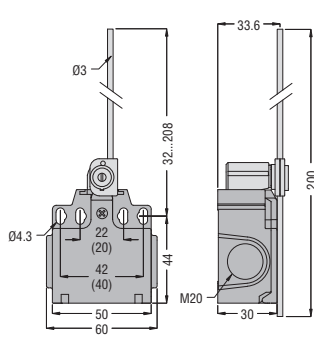

KB M1... - KB M2...
KM M1... - KM M2...

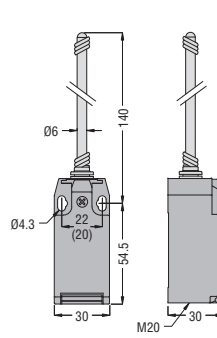

KC M1... - KC M2...
KN M1... - KN M2...

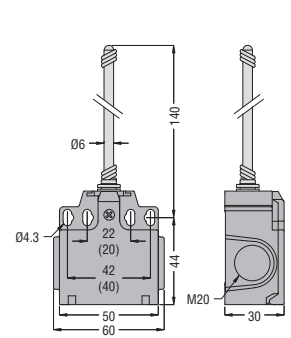

KB P1...
KM P1...

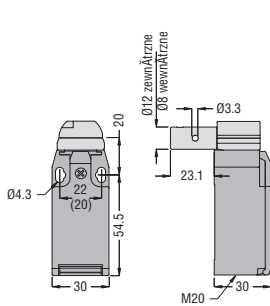

KB P2...
KM P2...

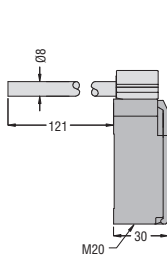

KB P3...
KM P3...

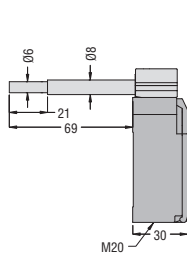

KC P1...
KN P1...

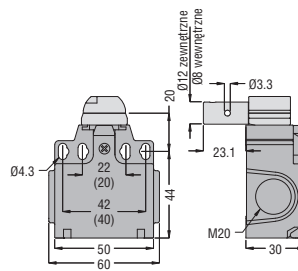

KC P2...
KN P2...

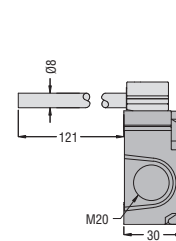

KC P3...
KN P3...

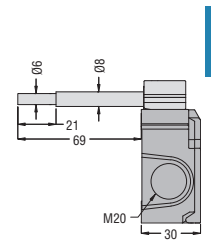

KB Q1 L...
KM Q1 L...

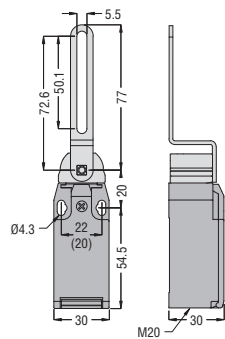

KC Q1 L...
KN Q1 L...

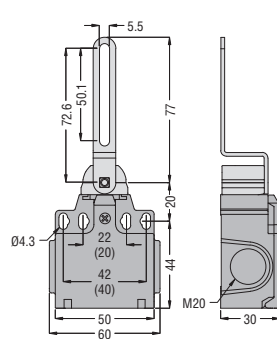

KB N1... - KB N2...
KM N1... - KM N2...

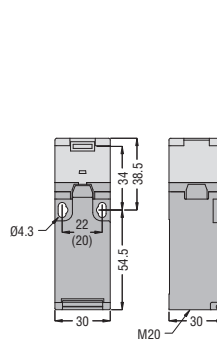

KC N1... - KC N2...

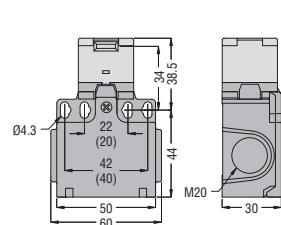

Klucze
KX N1

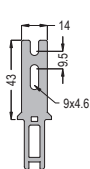

KX N2

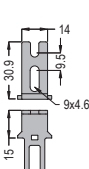

KX N3

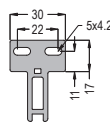

KX N4

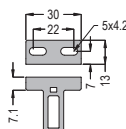

KX N5

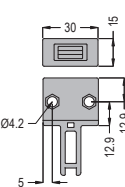

Dławnica
KX P01

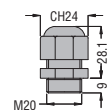

KX P02

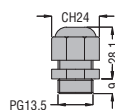

Dławnica
KX P03

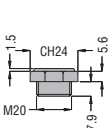

WYŁĄCZNIKI KRAŃCOWE Z KABELEM SERII K

KP A1...

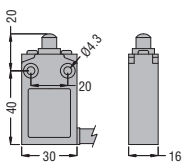

KP A2...

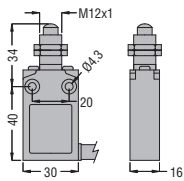

KP B1... - KP B2...

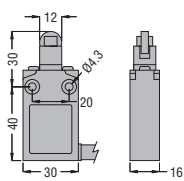

KP B3... - KP B4...

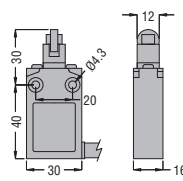

KP B5... - KP B6...

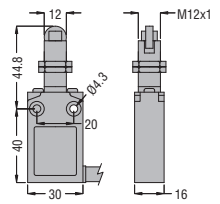

KP B7... - KP B8...

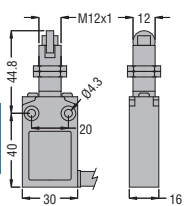

KP E1... - KP E2...

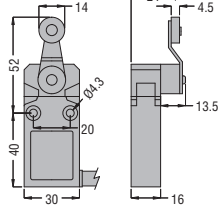

KP F1...

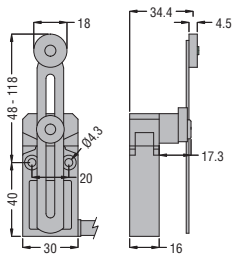

KP L2...

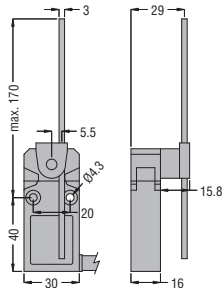

KP M2...

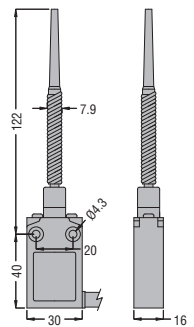

9

WYŁĄCZNIKI KRAŃCOWE SERII T

TS1 01...TL1 01...

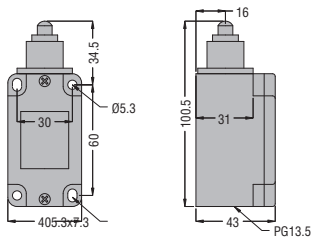

TS1 05 20...TL1 05 20
TS1 05 21...TL1 05 21

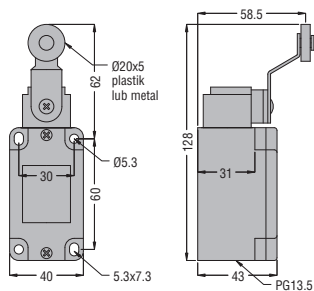

TS1 05 24...TL1 05 24

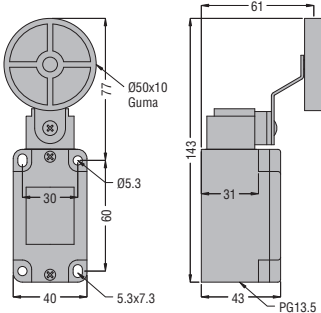

TS1 09...TL1 09...

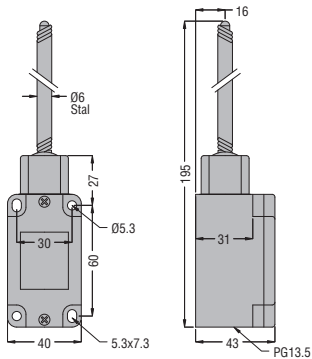

TL2 10...

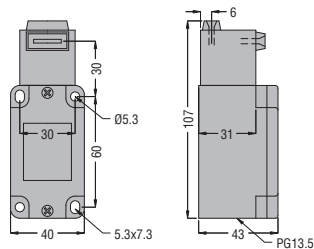

Klucze

P32752

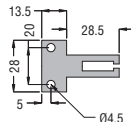

P32753

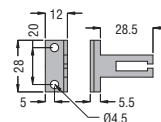

A20746

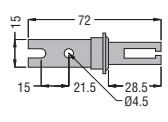

A20747

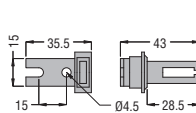

A20748

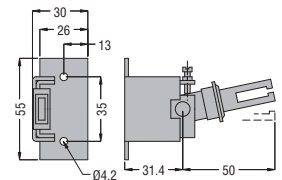

TS2 01...TL2 01...

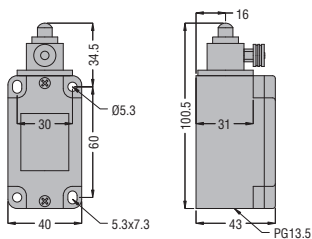

TS2 05 20...TL2 05 20
TS2 05 21...TL2 05 21

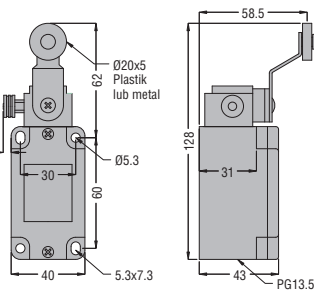

TS2 05 24...TL2 05 24

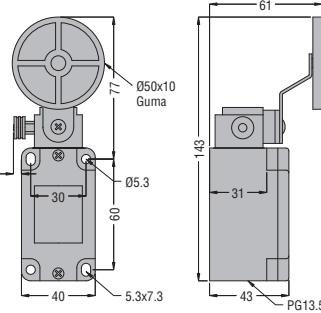

WYŁĄCZNIKI KRAŃCOWE METALOWE SERII PL

PLN...A

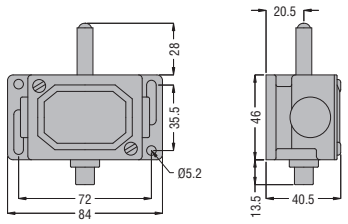

PLN...AW

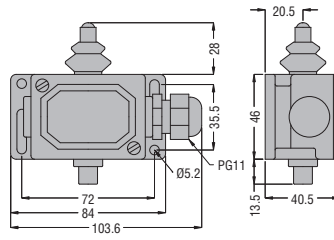

PLN...R

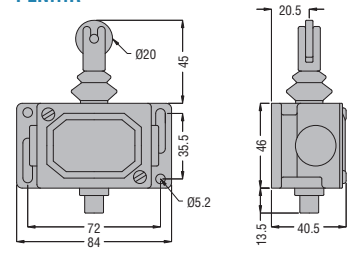

PLN...RW

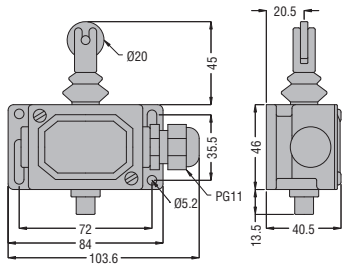

PLN...H

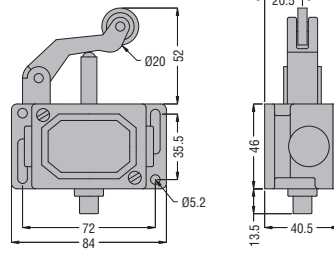

PLN...HW

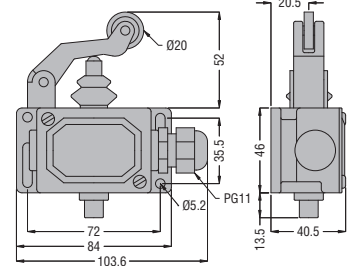

PLN...HSB

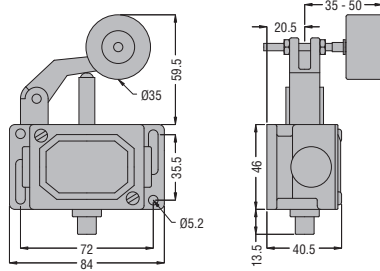

PLN...HSBW

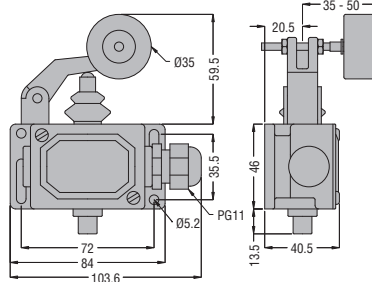

PLN A1 RAG

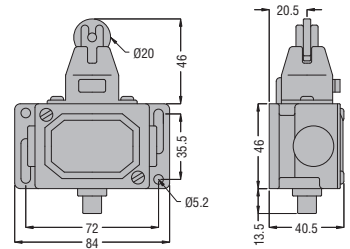

PLN A1 RAG W

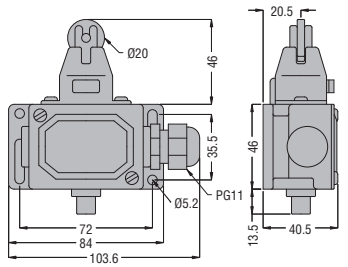

PLN A1 AM

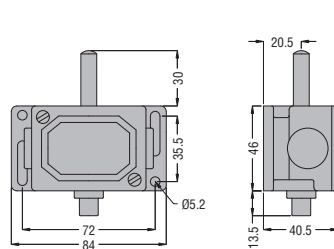

PL A1 AM W

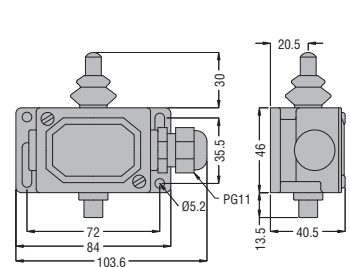

PL A1 RM

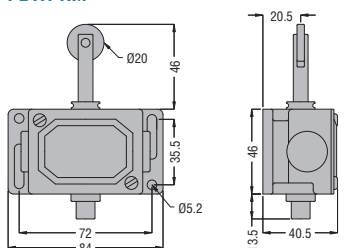

PL A1 RMW

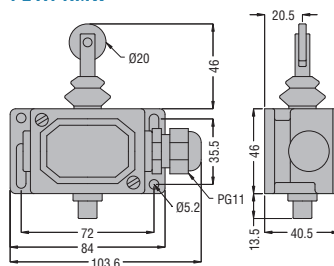

PLN 978

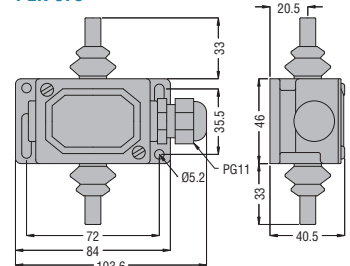

WYŁĄCZNIKI CIĄGNIONE – NORMALNE ZATRZYMANIE

RS1 13...RS3 13...

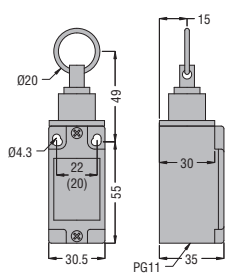

TS1 13...TL1 13...

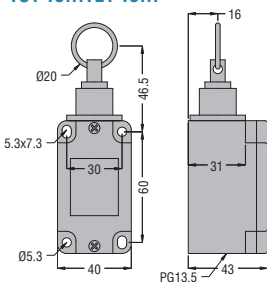

PLN...AT

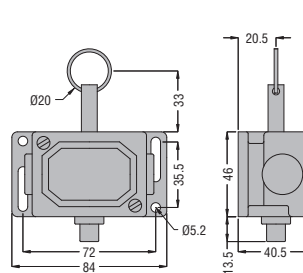

PLN...ATW

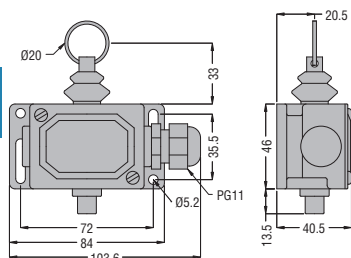

P2L...

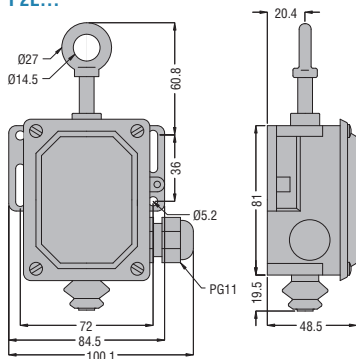

9

WYŁĄCZNIKI CIĄGNIONE – BEZPIECZEŃSTWA (ZGODNE Z ISO 13850)

RS13 13 10

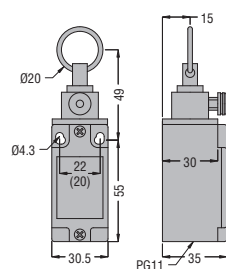

TL13 13 10

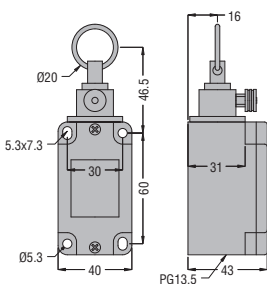

PLN13 13 11

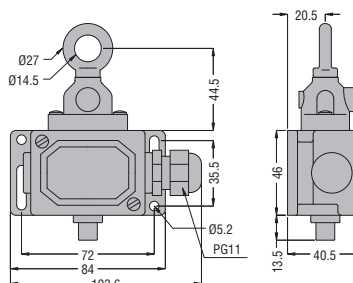

P2L 13...P2L 15...

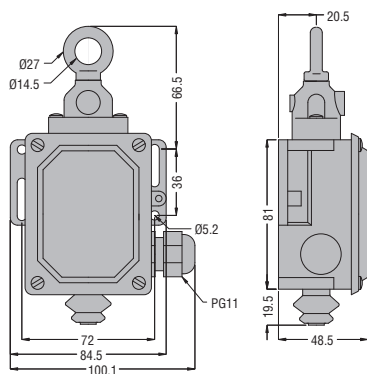

MIKROWYŁĄCZNIKI SERII K

KS A1...

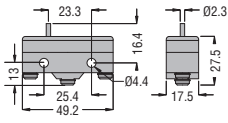

KS A2...

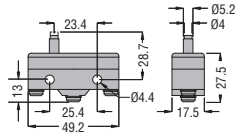

KS A3...

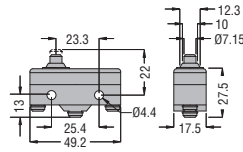

KS A4...

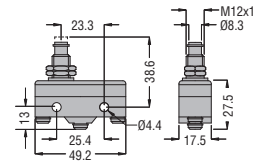

KS A9...

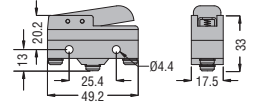

KS B1...

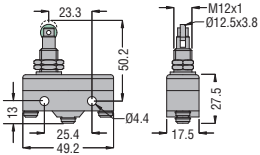

KS B2...

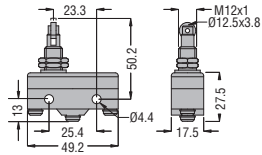

KS C1...

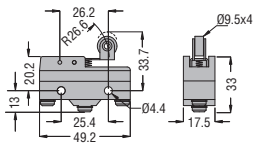

KS C2...

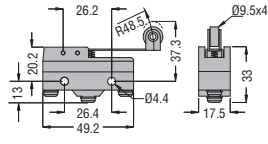

KS C3...

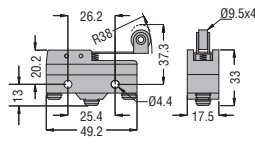

KS C9...

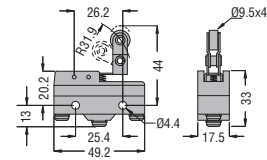

KS L1...

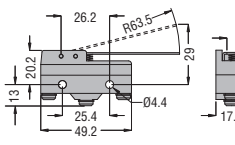

KS L2...

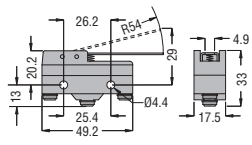

KS L3...

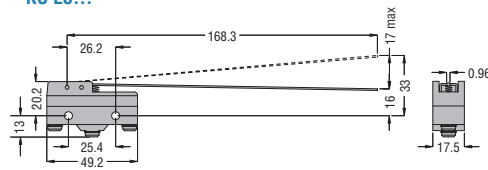

OSŁONA ZACISKÓW

KSS C01

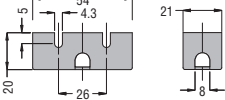

KSS CB2

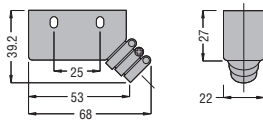

WYŁĄCZNIKI NOŻNE SERII K

KG1

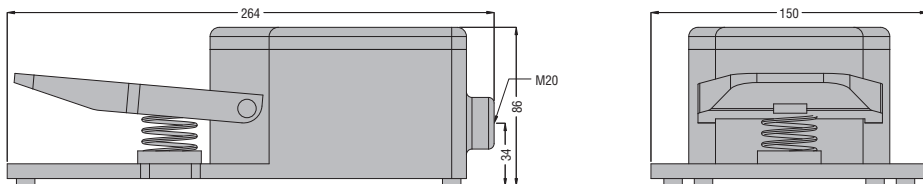

KG2

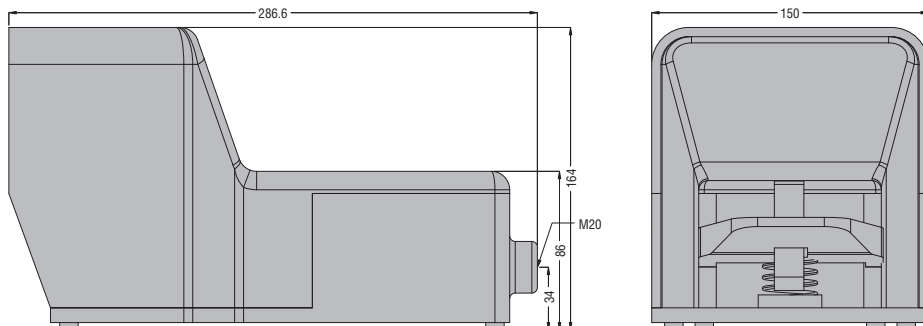

KR1

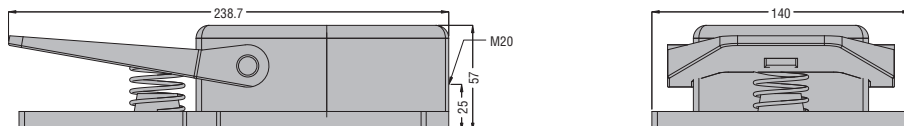

KR2

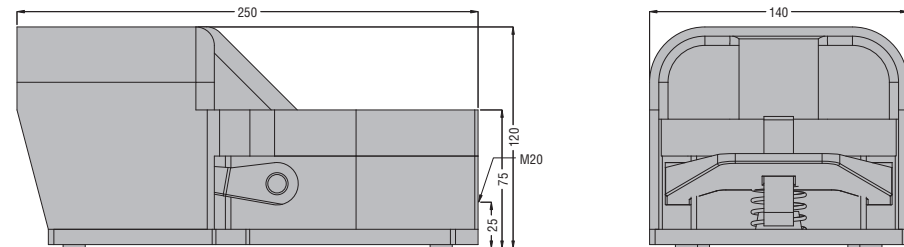

KGD

